

the 'Voyager'

JEWELRY CASE KIT INSTRUCTIONS

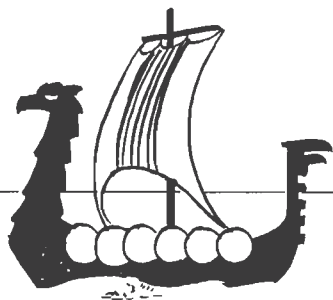

KIT CONTAINS:

- pre-cut case and lining
- solid brass clasp
- pattern and instructions



How to Assemble The "VOYAGER"

NOTE: All tooling must be done before assembling.

- Burnish the edges of box that are not to be laced. (See Fig. 1.) To burnish: rub with wax, or use Tandy's Edge Creaser. Finish with Neat Lac or Edge Dressing.
- Set bottom (anvil) part of clasp BEFORE cementing in lining. Make holes for anvil as indicated on tracing pattern, using awl, icepick, etc. Push prongs of anvil through leather from tooled side, fit back plate over prongs (on flesh side), and bend prongs down. Tap with mallet.
- Cement in lining:
NOTE: Both sides of lining leather are finished; use the surface of your choice. Apply rubber cement to the side which is NOT to show. Cement lining to tooled leather, one piece at a time: Apply cement to flesh side of leather piece and corresponding lining piece; allow to dry until tacky; fit pieces together. Smooth out any wrinkles. Repeat with each part.
- Set top (eyelet) part of clasp AFTER cementing in lining. Cut slot for eyelet as indicated on outline (top of page). Push prongs on top part of eyelet through leather from tooled side, fit back plate over prongs (on flesh side), and bend tabs down.
- Punch lacing holes:
Box is laced along edges indicated by heavy dotted lines, in illustration. Lacing holes should be punched along these edges. To get lacing holes even, match pieces as shown in drawings. Apply a thin film of rubber cement to the two top edges before you punch. (They can easily be pulled apart later.) Use 3 or 4 prong punch for even spacing. Punch lacing holes $\frac{1}{8}$ " apart and $\frac{1}{8}$ " from edge.
- Lace as indicated in drawings: around front, then around back, and last, sides (at bottom). (Instructions for Double Loop stitch on other side.)
NOTE: The reason for lacing in this order is so front corners will have a covered appearance when finished. Lace through corner holes twice. (The next hole away from corners can also be laced through twice if you wish.)

How to Lace Western Double Loop Stitch

How to Splice

I. Here are the parts in your kit:

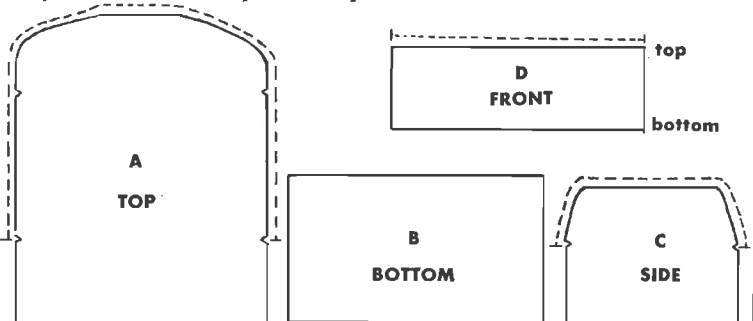

Burnish edges indicated by dotted lines.

II. Set anvil:

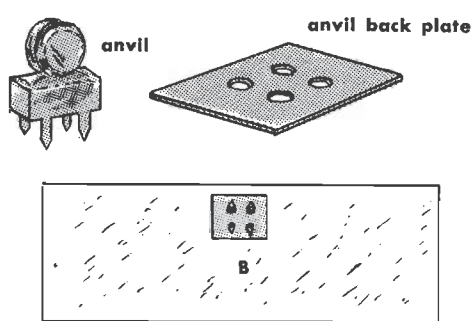

III. Cement in lining:

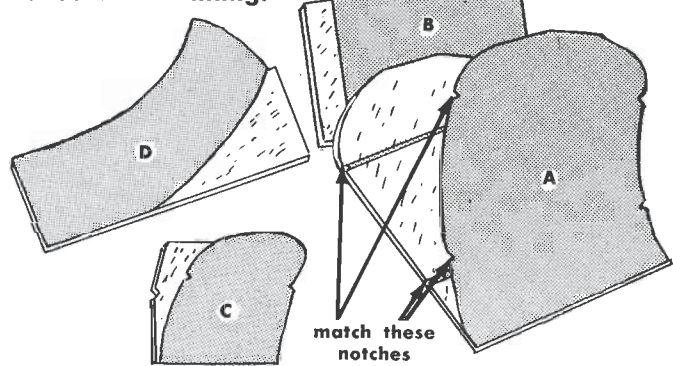

IV. Set eyelet.

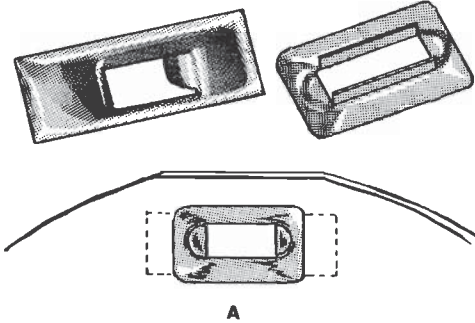

V. Punch lacing holes:

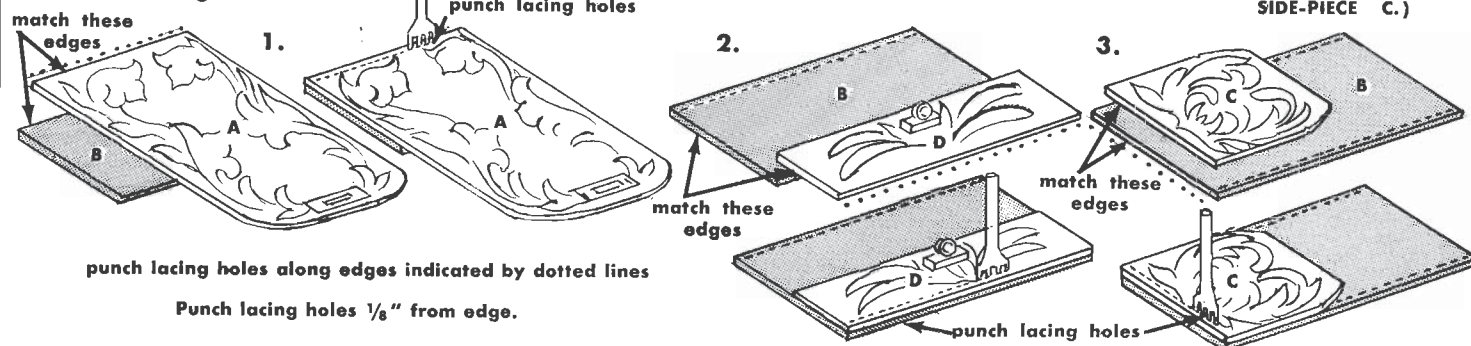

V. Punch lacing holes:

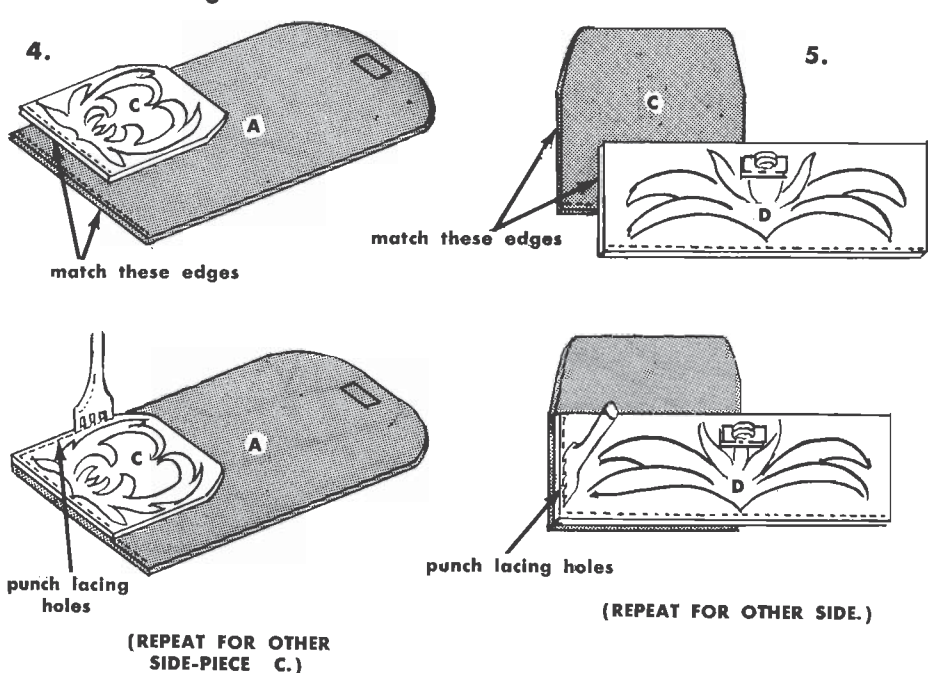

VI. Lace:

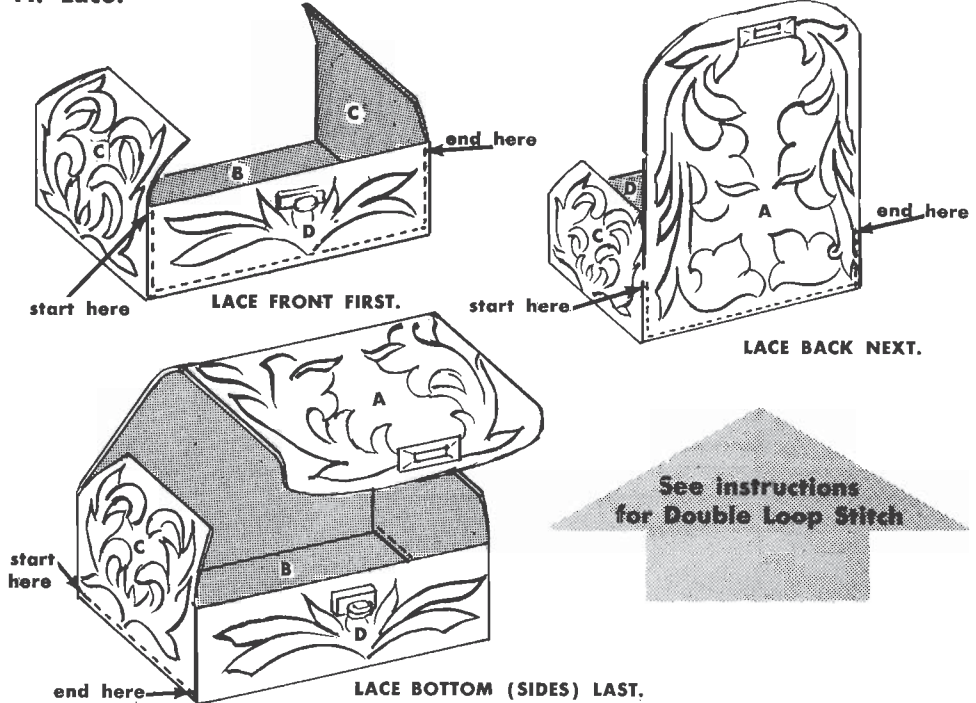

the 'Voyager'

JEWELRY CASE KIT INSTRUCTIONS

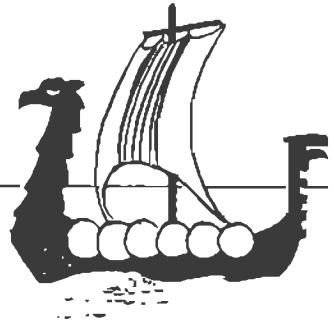

KIT CONTAINS:

- pre-cut case and lining
- solid brass clasp
- pattern and instructions



How to Assemble The "VOYAGER"

NOTE: All tooling must be done before assembling.

1. Burnish the edges of box that are not to be laced. (See Fig. 1.) To burnish: rub with wax, or use Tandy's Edge Creaser. Finish with Neat Lac or Edge Dressing.
2. Set bottom (anvil) part of clasp BEFORE cementing in lining. Make holes for anvil as indicated on tracing pattern, using awl, icepick, etc. Push prongs of anvil through leather from tooled side, fit back plate over prongs (on flesh side), and bend prongs down. Tap with mallet.
3. Cement in lining:
NOTE: Both sides of lining leather are finished; use the surface of your choice. Apply rubber cement to the side which is NOT to show.
Cement lining to tooled leather, one piece at a time: Apply cement to flesh side of leather piece and corresponding lining piece; allow to dry until tacky; fit pieces together. Smooth out any wrinkles. Repeat with each part.
4. Set top (eyelet) part of clasp AFTER cementing in lining. Cut slot for eyelet as indicated on outline (top of page). Push prongs on top part of eyelet through leather from tooled side, fit back plate over prongs (on flesh side), and
5. Punch lacing holes:
Box is laced along edges indicated by heavy dotted lines, in illustration. Lacing holes should be punched along these edges. To get lacing holes even, match pieces as shown in drawings. Apply a thin film of rubber cement to the two top edges before you punch. (They can easily be pulled apart later.) Use 3 or 4 prong punch for even spacing. Punch lacing holes $\frac{1}{8}$ " apart and $\frac{1}{8}$ " from edge.
6. Lace as indicated in drawings: around front, then around back, and last, side (at bottom). (Instructions for Double Loop stitch on other side.)
NOTE: The reason for lacing in this order is so front corners will have a covered appearance when finished.
Lace through corner holes twice. (The next hole away from corners can also be laced through twice if you wish.)

How to Lace Western Double Loop Stitch

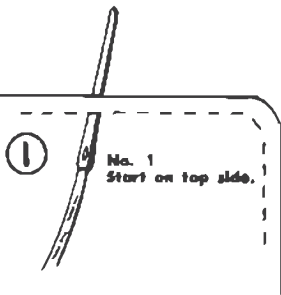

① No. 1
Start on top side.

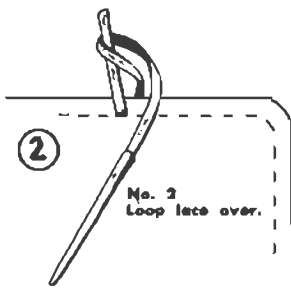

② No. 2
Loop lace over.

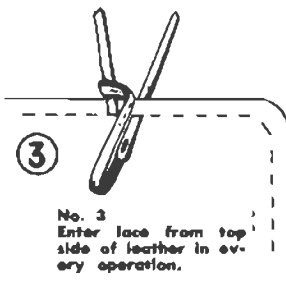

③ No. 3
Enter lace from top side of leather in every operation.

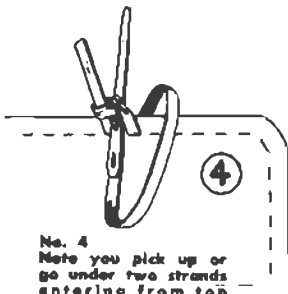

④ No. 4
Note you pick up or go under two strands entering from top side. This is really where you start the double face.

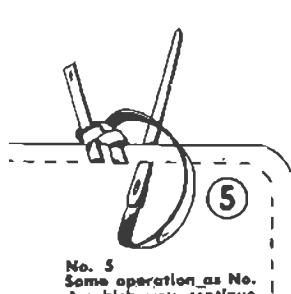

⑤ No. 5
Same operation as No. 4 which you continue until you have finished.

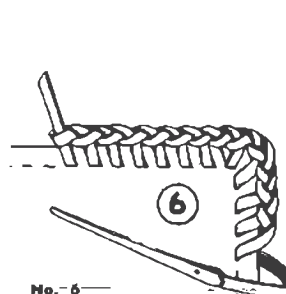

⑥ No. 6
Continuous of No. 4 and 5.



⑦ No. 7
Cut your corners round using the end slit or hole twice. If you prefer you can use the corner slit three times.

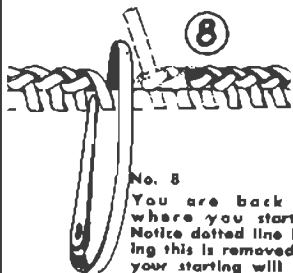

⑧ No. 8
You are back to where you started. Notice dotted line lacing this is removed so your starting will appear as in No. 9.



⑨ No. 9
Note only one hole remains unlaced.

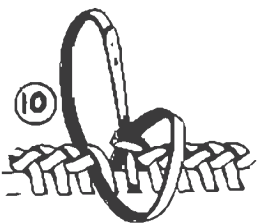

⑩ No. 10 Completion of the tie-in.

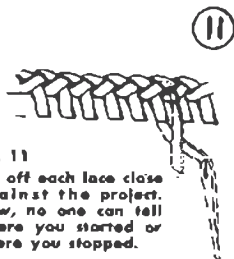

⑪ No. 11
Cut off each lace close against the project. Now, no one can tell where you started or where you stopped.

While lace is still damp lay project on firm surface and beat

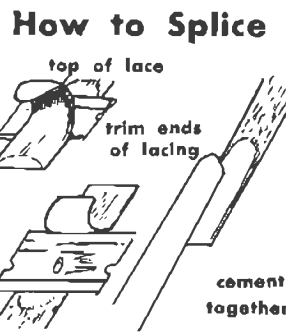

How to Splice

top of lace
trim ends of lacing
cement together

bend tabs down.

I. Here are the parts in your kit:

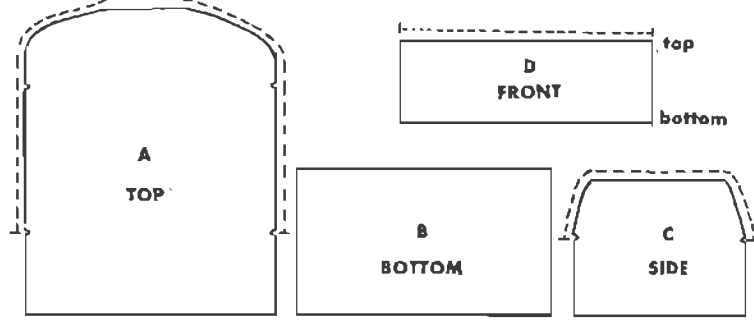

Burnish edges indicated by dotted lines.

II. Set anvil:

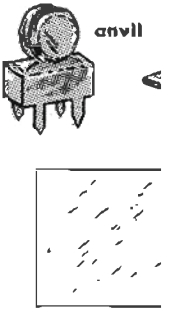

IV. Set eyelet.

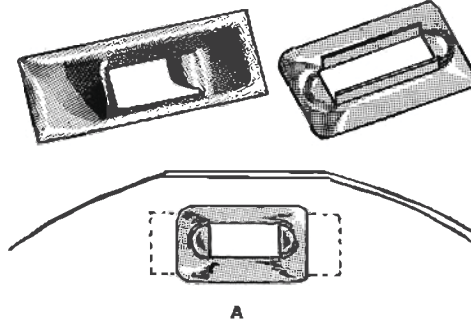

V. Punch lacing holes:

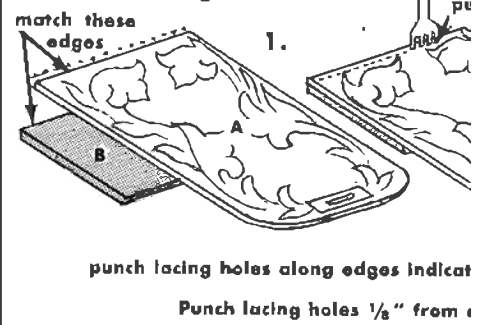

V. Punch lacing holes:

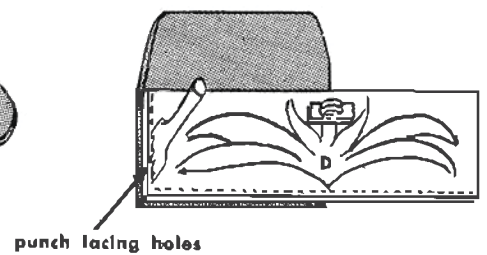
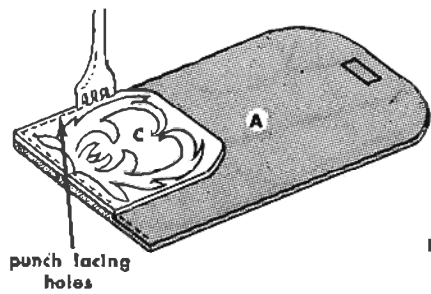
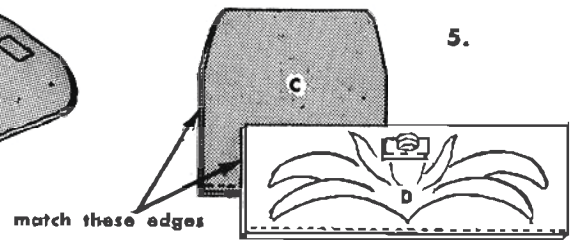
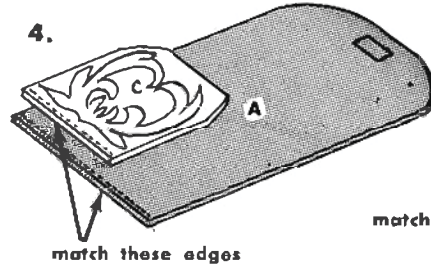

(REPEAT FOR OTHER SIDE.)

(REPEAT FOR OTHER SIDE-PIECE C.)

down with mallet.

flesh side

anvil back plate

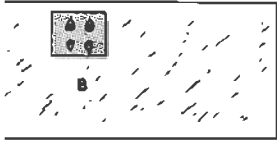
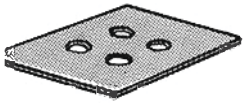

III. Cement in lining:

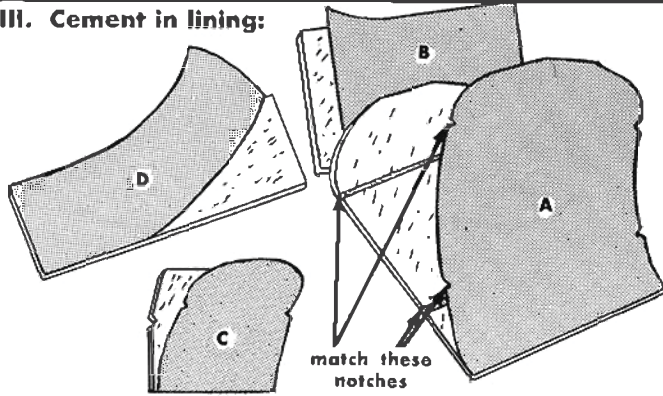

1/2 inch lacing holes

(REPEAT FOR OTHER SIDE-PIECE C.)

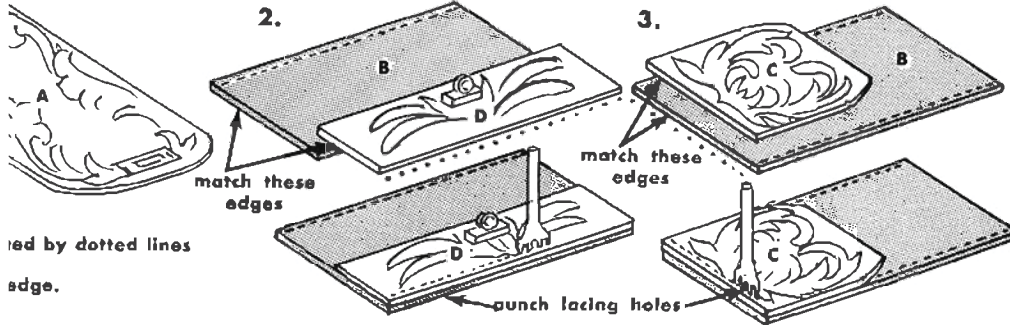

Follow edge by dotted lines

VI. Lace:

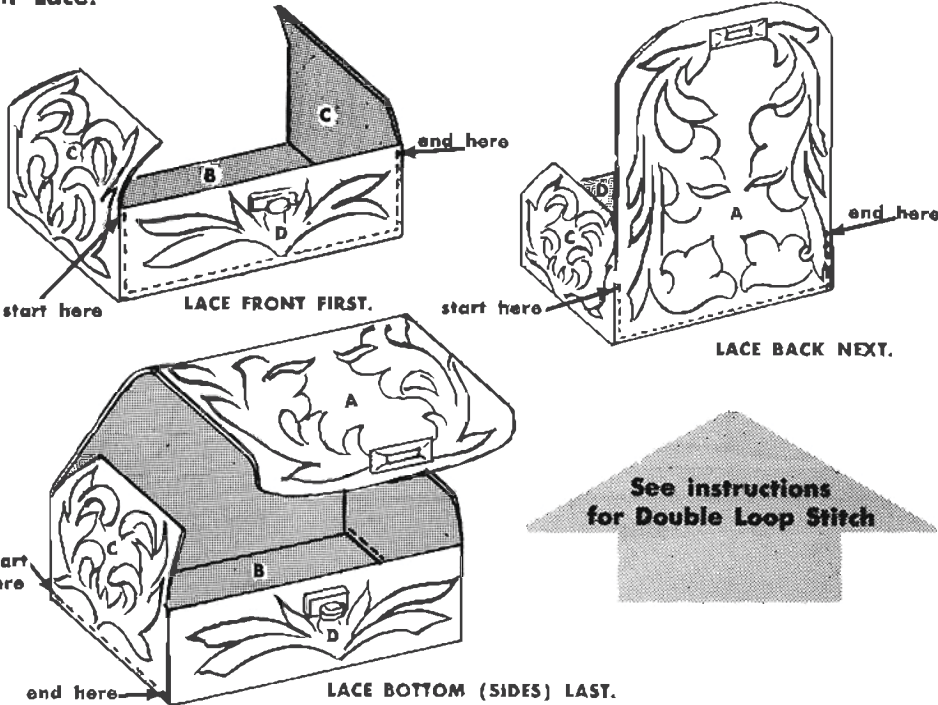

How to Carve The "VOYAGER"

Tooling must be done first, before assembling.

1. Dampen the leather evenly with a sponge. Do not saturate the leather. Allow surface moisture to evaporate.
2. Trace the outline of the design onto the smooth side of the leather.
3. Cut the outline of the design into the leather with a swivel knife. Cut to a depth one-half the thickness of the leather.
4. Stamping:
Use the camouflage tool ("cam") to decorate stems and petals, to fill in blank areas, etc. The pear shader adds contour shading to the design. (By hitting some strokes harder than others, you can produce deeper shading as desired.) Use the veiner to put evenly spaced veins in the leaves. The seeder is used to make the "seeds" at flower centers, etc. Beveling gives a three dimensional effect. Remember: Bevel ONLY on ONE SIDE of swivel cuts. Use a background tool to stamp the background areas. This should be smooth, level, and uniform. Depth should be the same as the swivel cuts. NOTE: Stamping tools may be used in a different order if you wish.
5. Decorative cuts (with the swivel knife) are done last.
6. Apply neat-Lac or Neat-Shene leather finisher thinly.

To Save Tracing Pattern & Instructions, trace Pattern to tracing paper..... then to leather.

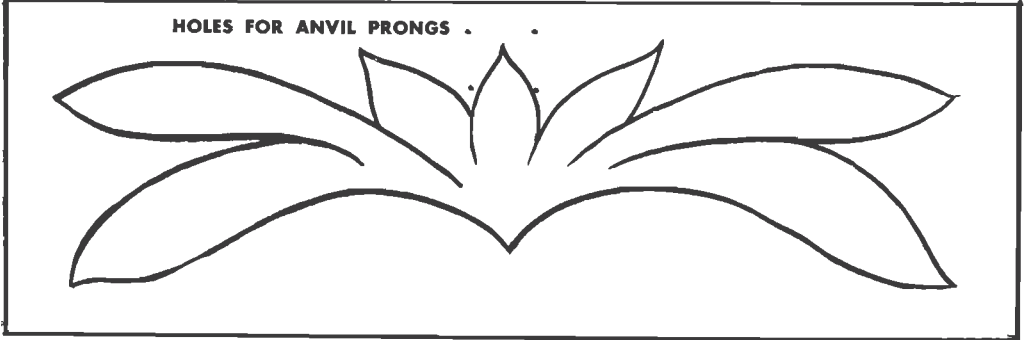

FRONT

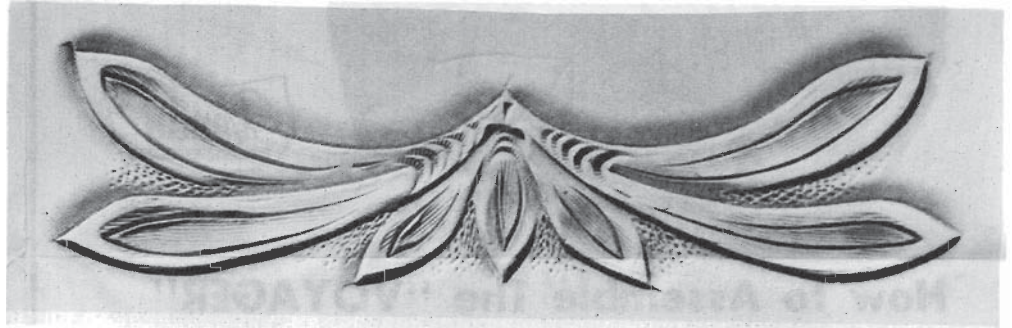

Photocarve Pattern



SIDE

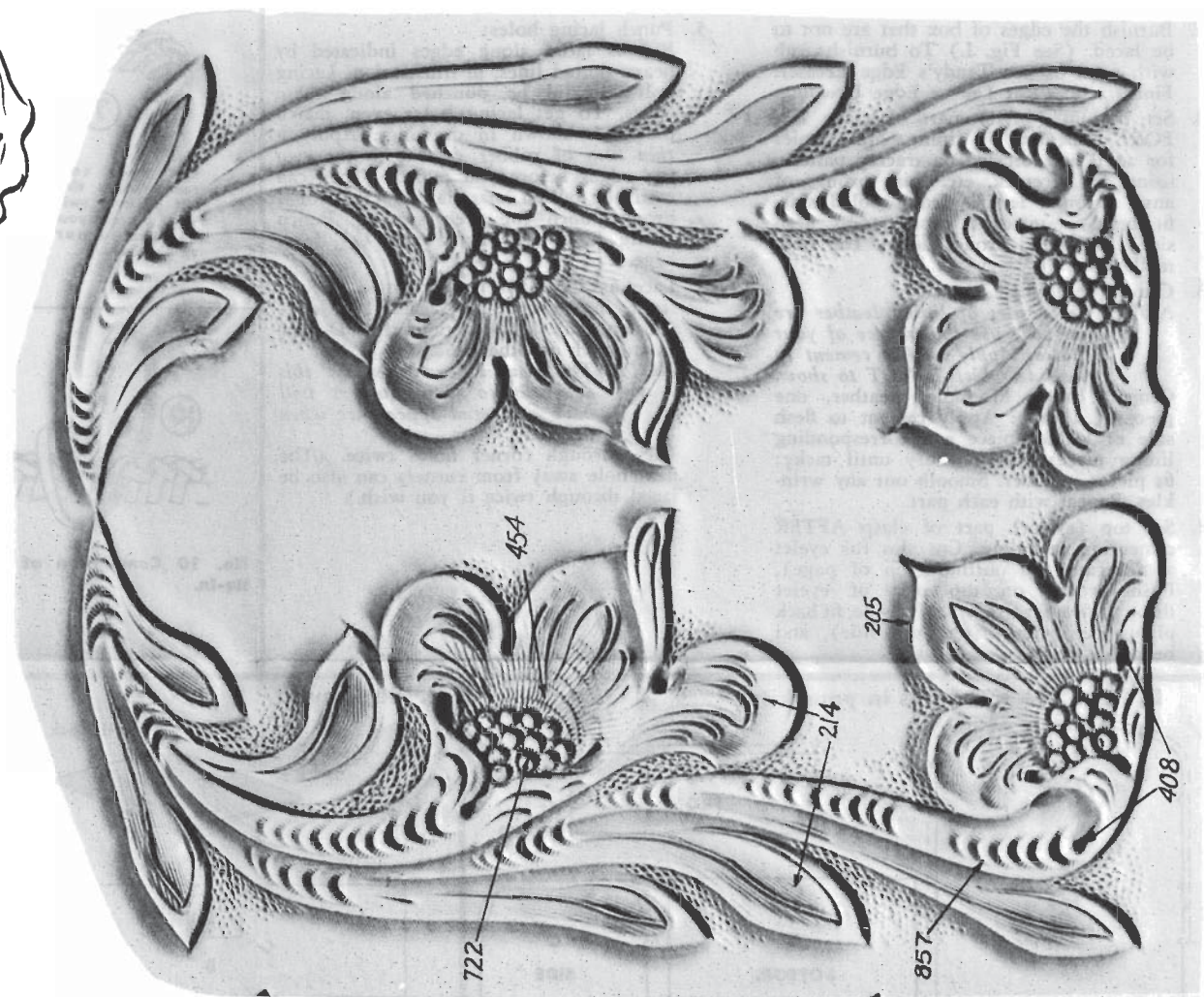

TOP & FLAP



PRINTED IN USA

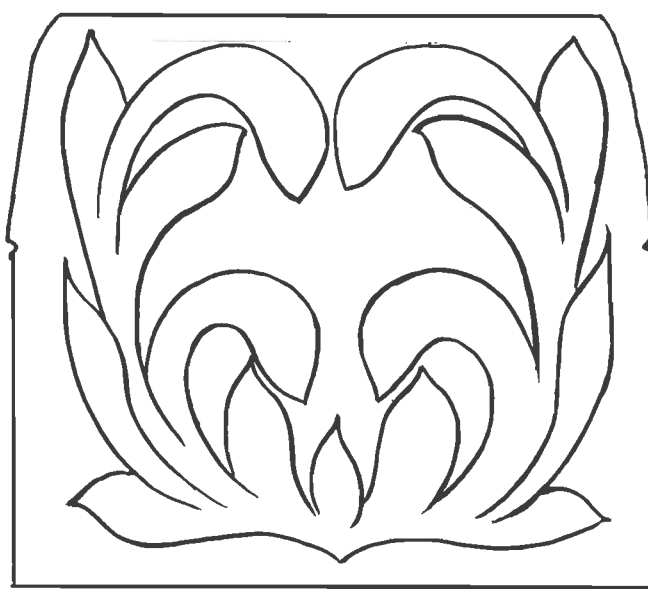

SIDE

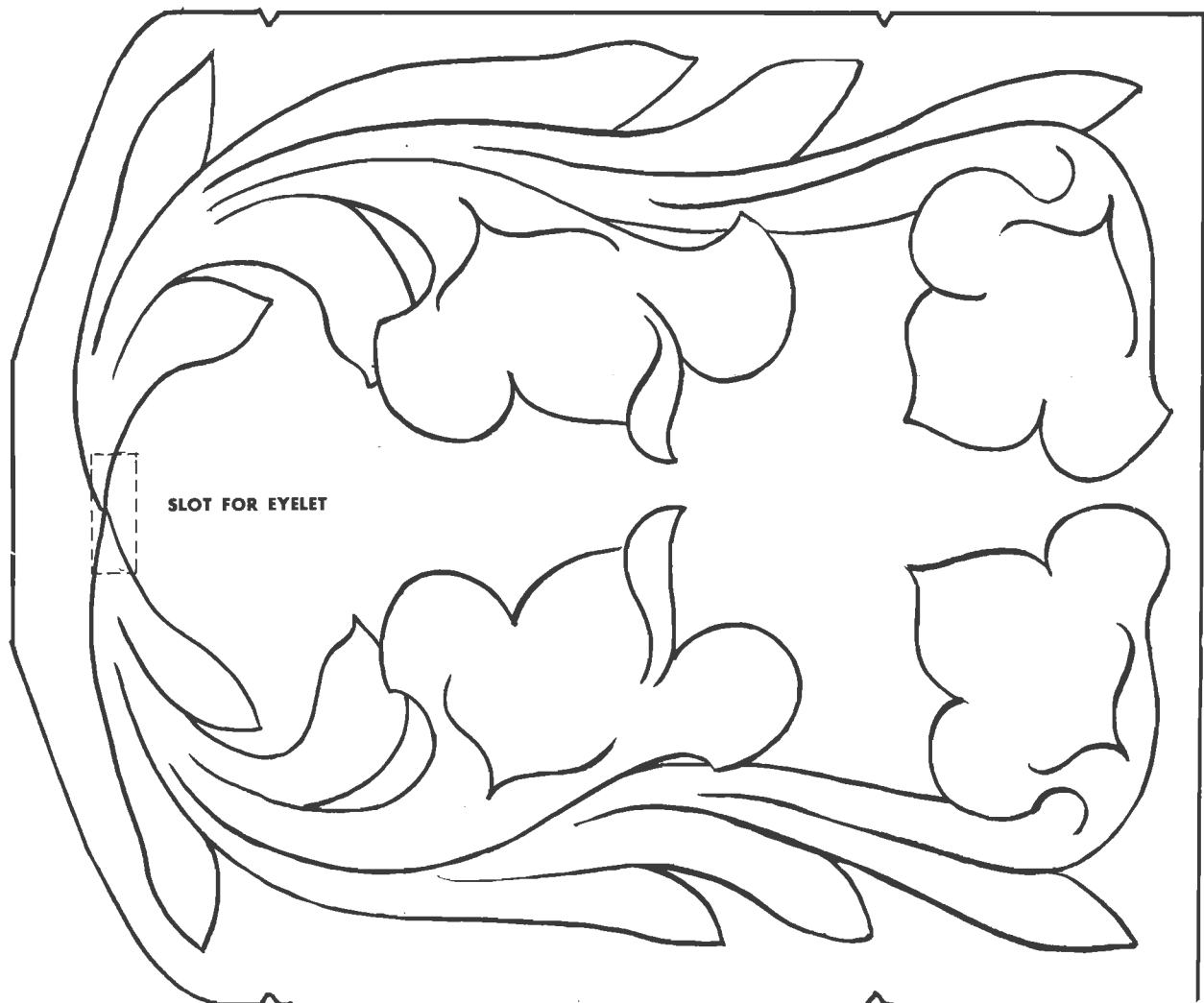

How to Carve The "VOYAGER"

Tooling must be done first, before assembling.

1. Dampen the leather evenly with a sponge. Do not saturate the leather. Allow surface moisture to evaporate.
2. Trace the outline of the design onto the smooth side of the leather.
3. Cut the outline of the design into the leather with a swivel knife. Cut to a depth one-half the thickness of the leather.
4. Stamping:
Use the camouflage tool ("cam") to decorate stems and petals, to fill in blank areas, etc. The pear shader adds contour shading to the design. (By hitting some strokes harder than others, you can produce deeper shading as desired.) Use the veiner to put evenly spaced veins in the leaves. The seeder is used to make the "seeds" at flower centers, etc.
Beveling gives a three dimensional effect. Remember: Bevel ONLY on ONE SIDE of swivel cuts.
Use a background tool to stamp the background areas. This should be smooth, level, and uniform. Depth should be the same as the swivel cuts.
NOTE: Stamping tools may be used in a different order if you wish.
5. Decorative cuts (with the swivel knife) are done last.
6. Apply neat-Lac or Neat-Shene leather finisher thinly.

To Save Tracing Pattern & Instructions, trace Pattern to tracing paper..... then to leather.

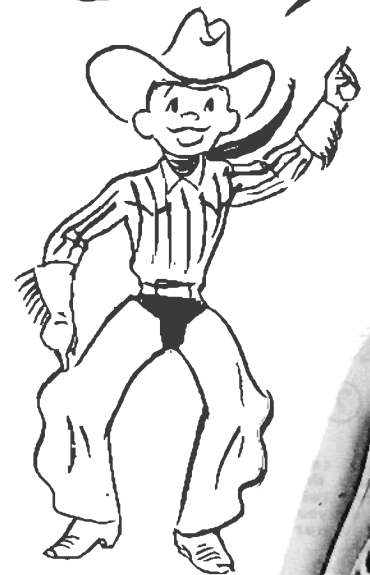

Photocarve Pattern



HOLES FOR ANVIL PRONGS . . .



FRONT

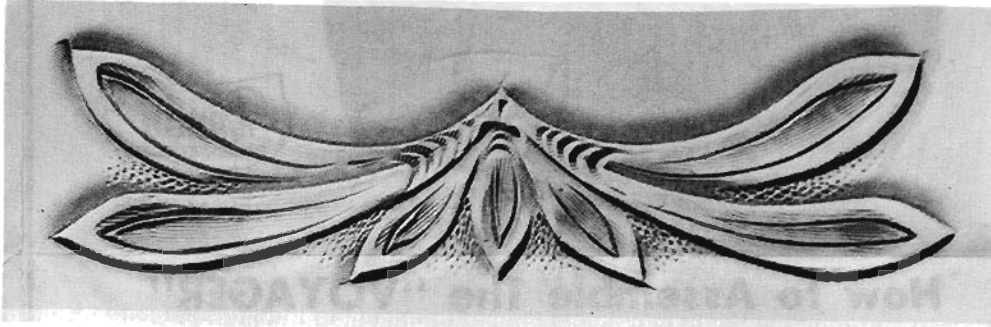

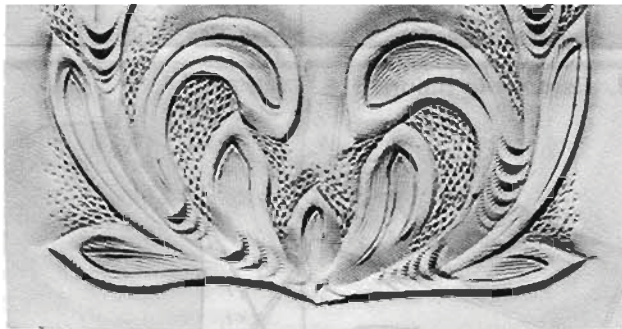

SIDE



PRINTED IN USA

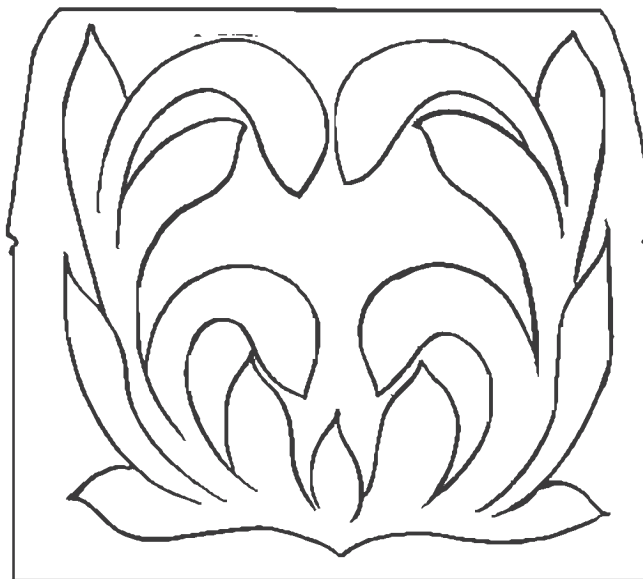

SIDE

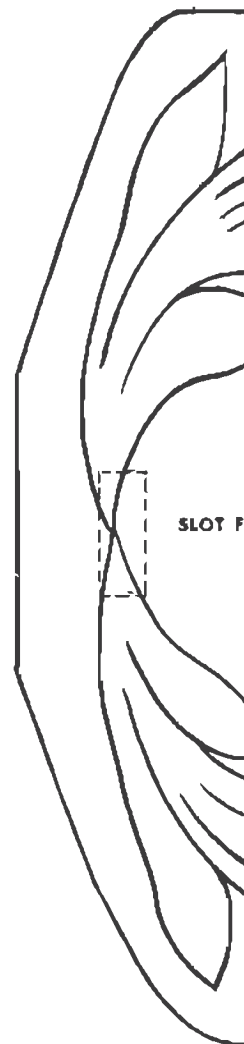

SLOT P

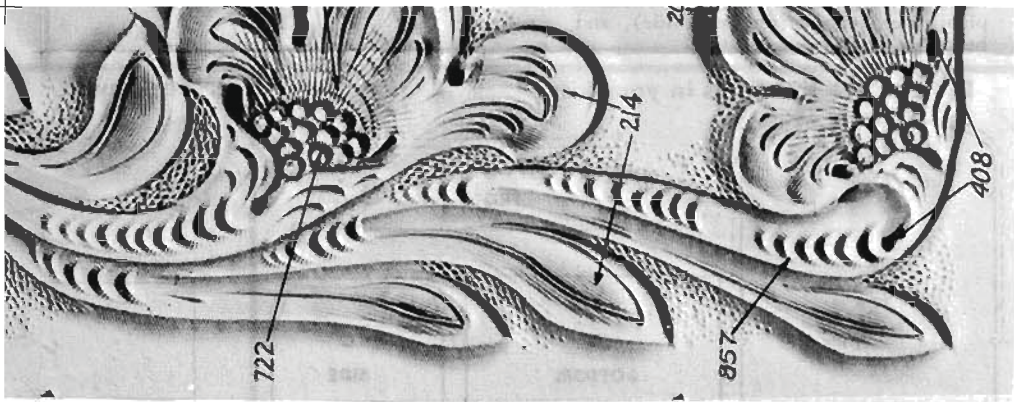

TOP & FLAP

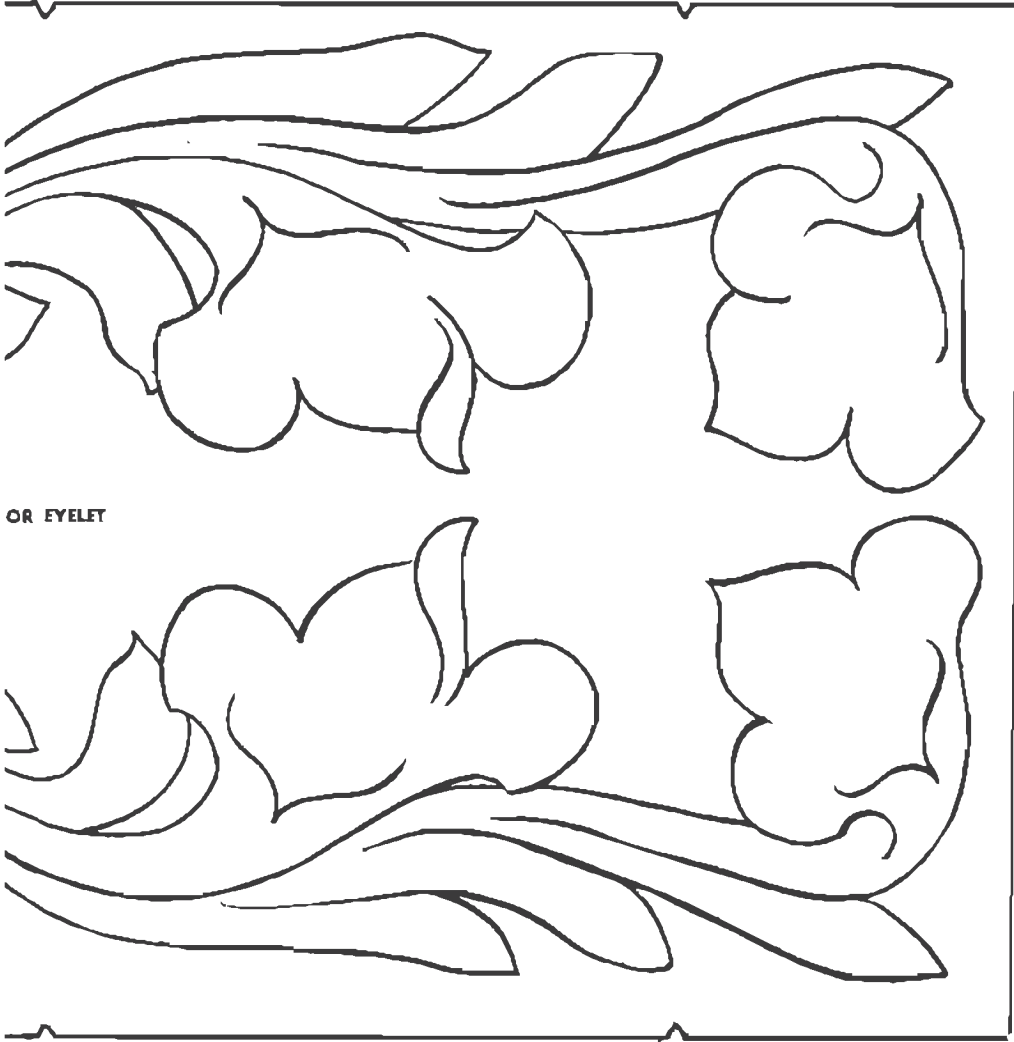

OR EYELET

(No part of this or any other page may be reproduced without written permission)