

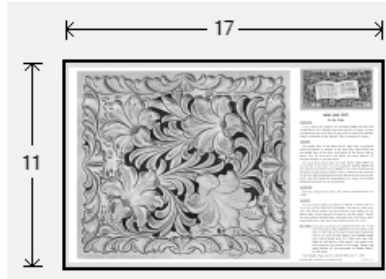

## Doodle Page Digital Download

This PDF file contains 1 (one) Doodle Page. The PDF has been put together to give you options when it comes to printing. Pages and patterns that are larger than 8½x11 have been provided in two formats:



### 1) Full Size

If you would like to have a full size print out, take the full size pages to your local print shop and they can print it for you. All full size Doodle Pages are 11x17

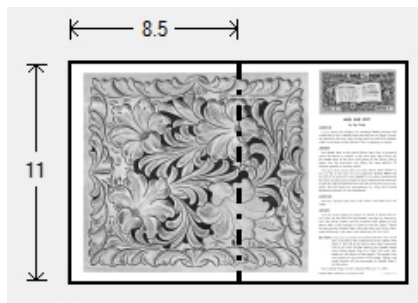

### 2) Tiled

The tiled pages give you the option of printing the full sized Doodle Pages at home. You print the tiled pages and then assemble them to make the larger patterns.

The Doodle Page PDF files are typically laid out like this:

Front – full sized, front – tiled, back – full sized, back – tiled

(Some Doodle Pages do not have backs)

Please note: When printing on a home printer, the edges may get cut off. To avoid this, make sure “Page Scaling” is set to “Shrink to Printable Area” in the Adobe Reader print dialogue box. This will decrease the size of the Doodle Page a very small amount.

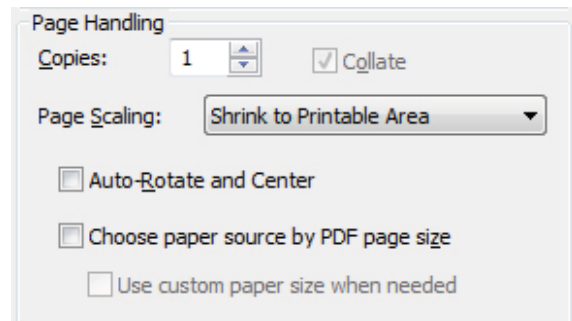

You may take this PDF file to your local print shop to have the full-size pages printed for your own personal use.

# Photo-Carve Pattern

ALTERNATE  
SAVER DESIGN

GLASSES CASE

HIDDEN MONEY  
BELT SAVER

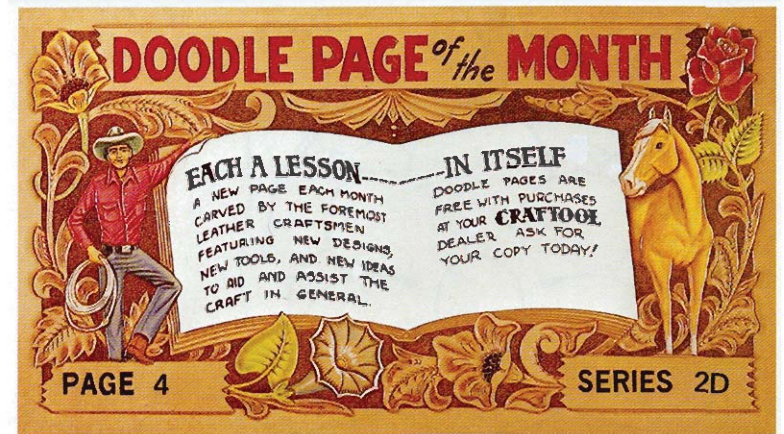
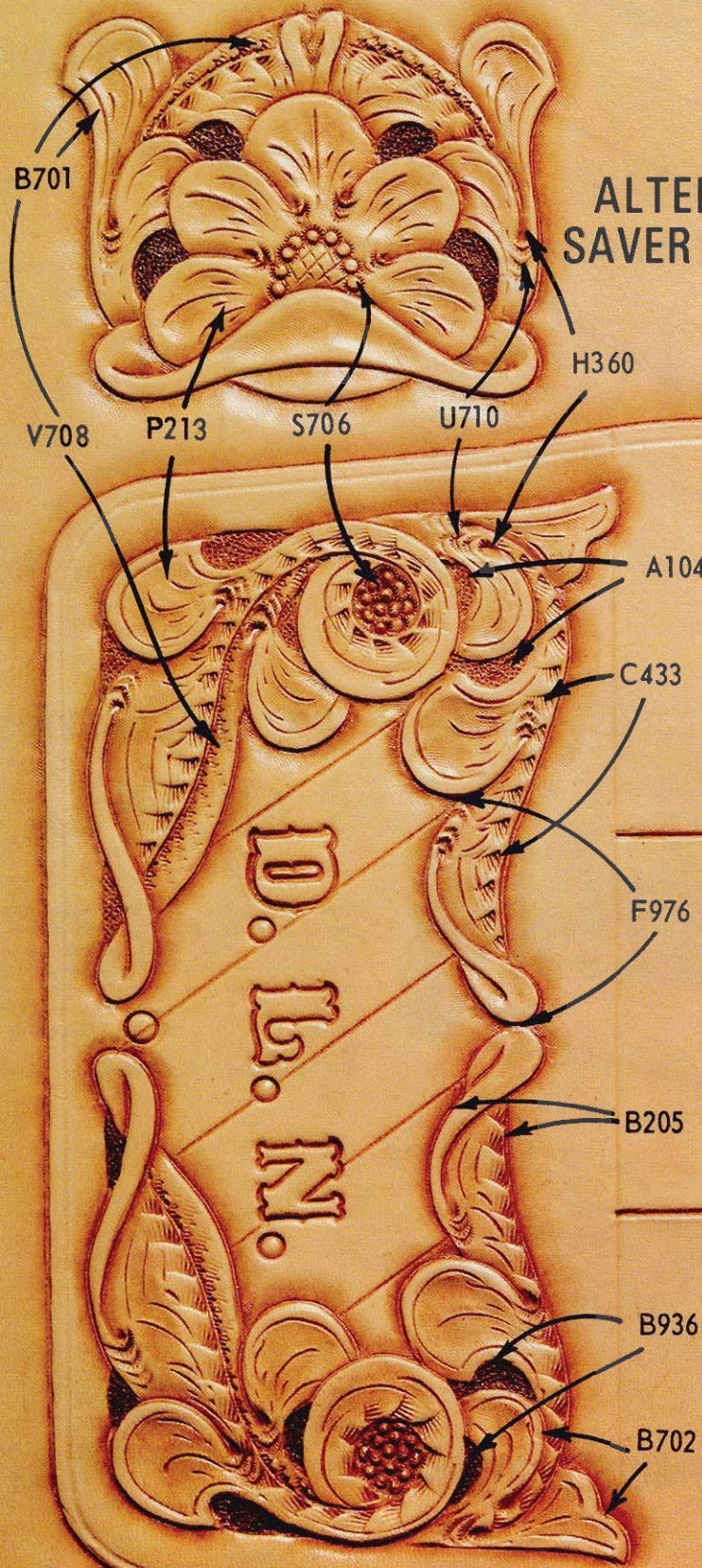

## "LEATHER SIGHT & SAVE" by Dennis Noland

A lot of people carry change purses and money clips in their pockets and some have hidden money belts, so I thought this hidden money belt saver would be a good project to make. It is folded over and down on the inside of your waistband with your belt going through the front part. No one would know you had money hidden on you with this project.

The belt loop is folded up and sewed across and this way your belt will go through. Then the money pocket is folded up to meet this and the sides are sewn to form the pocket. This way you can pull the pocket up out of the waistband of your pants, take out the money or put some in, then put it back again. This just looks like another piece of carved leather accessory.

Dad made the Glasses Case before and wanted me to put it in with my idea so I carved it up for this Doodle Page. I did all the carving and Dad did all the lettering and drawing. I like leather carving very much.

The cardboard liner can be covered with felt paper or cloth or maybe thin suede leather to protect your glasses. The wooden nose support is made out of a soft piece of pine and nailed or glued to the inside. Then tape the sides together and it is ready to fit in the case.

If you line the back of the carved case, Dad said to be sure to not glue the part where the belt goes through. This should be carved out of 4-5 ounce leather. Next fold up the sides and start at the bottom and lace around the outside till you reach the bottom of the other side.

I hope the assembling detail is plain enough for you to understand.

I hope you like these projects and Good Luck in Leather Carving.

# Photo-Carve Pattern

ALTERNATE  
SAVER DESIGN

GLASSES CASE

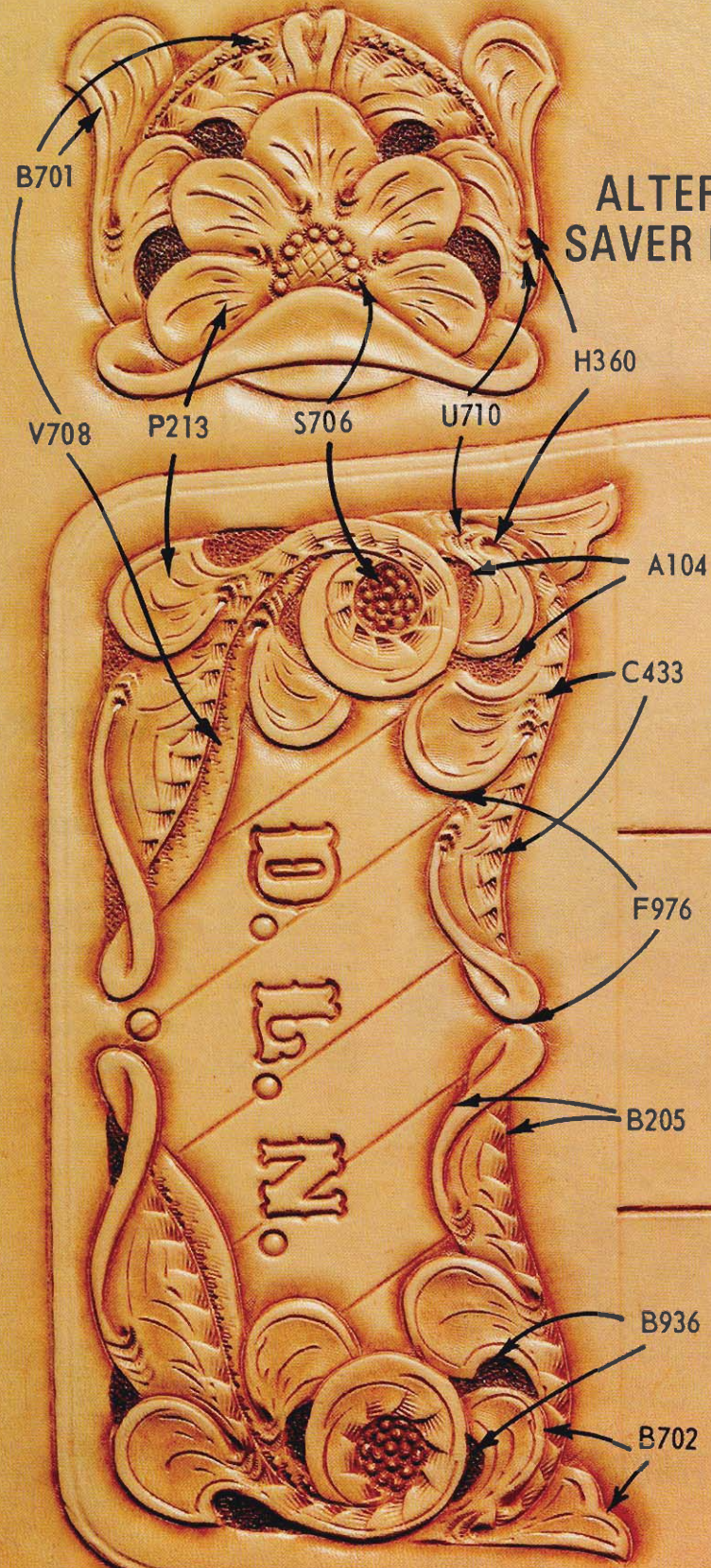

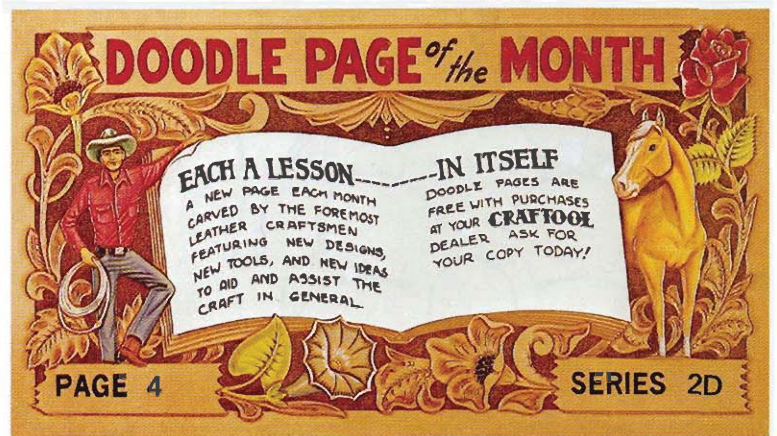

## “LEATHER SIGHT & SAVE”

by Dennis Noland

A lot of people carry change purses and money clips in their pockets and some have hidden money belts, so I thought this hidden money belt saver would be a good project to make. It is folded over and down on the inside of your waistband with your belt going through the front part. No one would know you had money hidden on you with this project.

The belt loop is folded up and sewed across and this way your belt will go through. Then the money pocket is folded up to meet this and the sides are sewn to form the pocket. This way you can pull the pocket up out of the waistband of your pants, take out the money or put some in, then put it back again. This just looks like another piece of carved leather accessory.

Dad made the Glasses Case before and wanted me to put it in with my idea so I carved it up for this Doodle Page. I did all the carving and Dad did all the lettering and drawing. I like leather carving very much.

The cardboard liner can be covered with felt paper or cloth or maybe thin suede leather to protect your glasses. The wooden nose support is made out of a soft piece of pine and nailed or glued to the inside. Then tape the sides together and it is ready to fit in the case.

If you line the back of the carved case, Dad said to be sure to not glue the part where the belt goes through. This should be carved out of 4-5 ounce leather. Next fold up the sides and start at the bottom and lace around the outside till you reach the bottom of the other side.

I hope the assembling detail is plain enough for you to understand.

I hope you like these projects and Good Luck in Leather Carving.

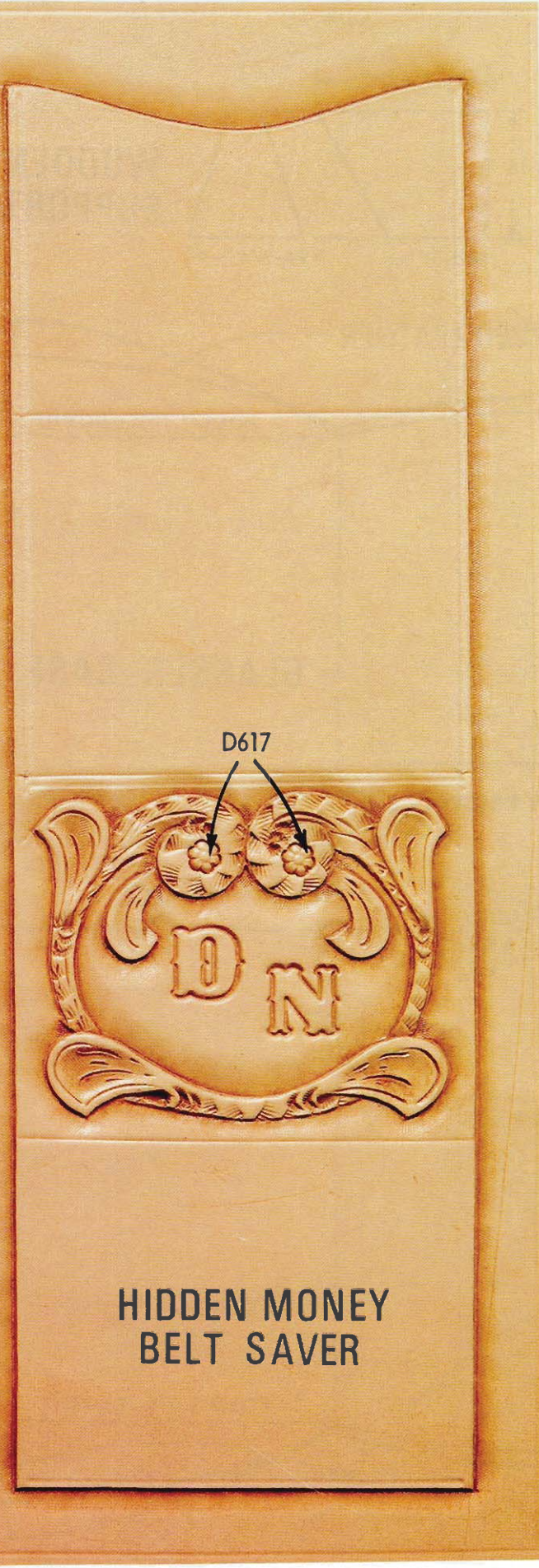

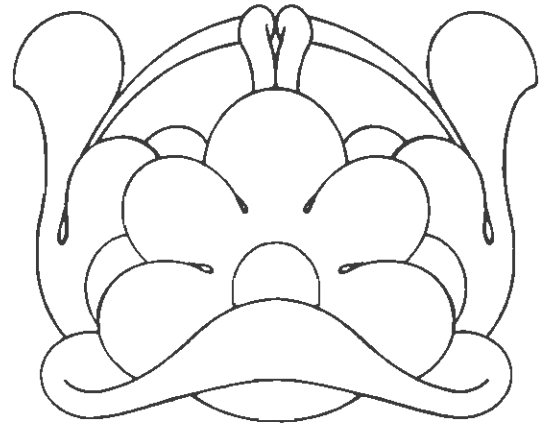

ALTERNATE SAVER DESIGN

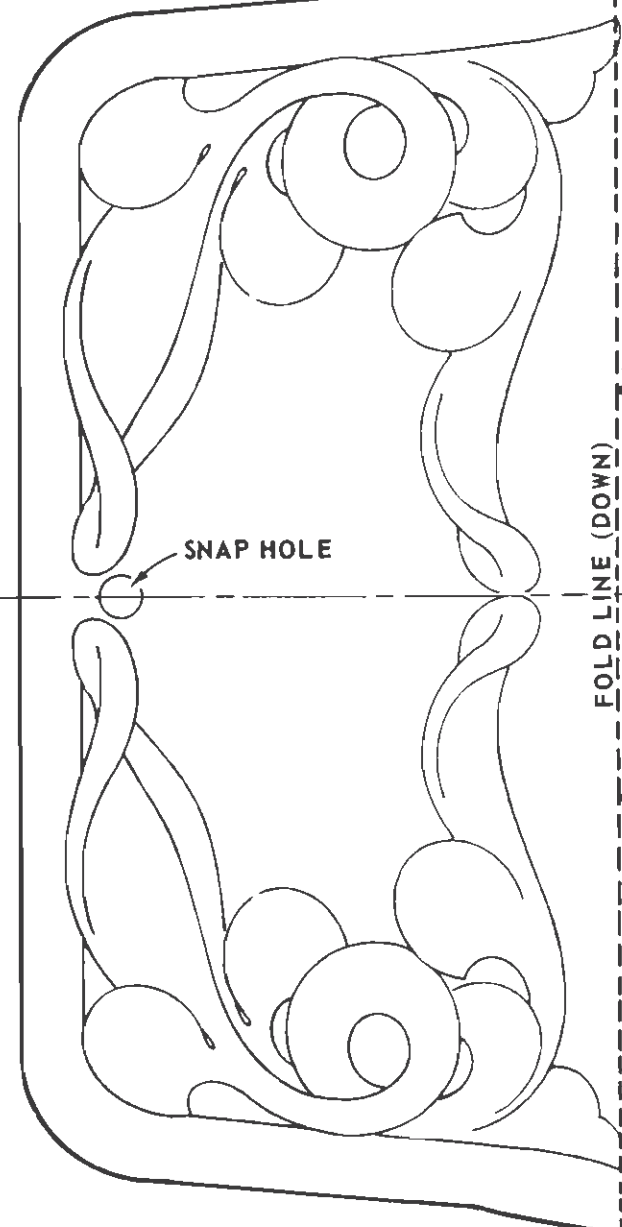

Tracing Pattern

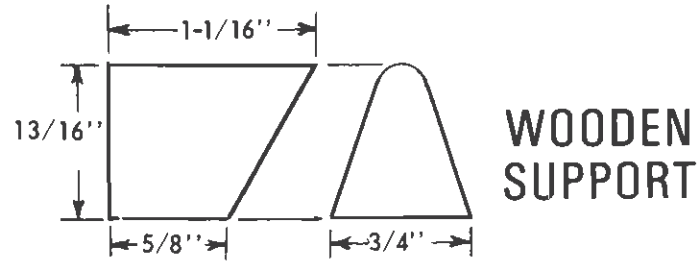

WOODEN SUPPORT

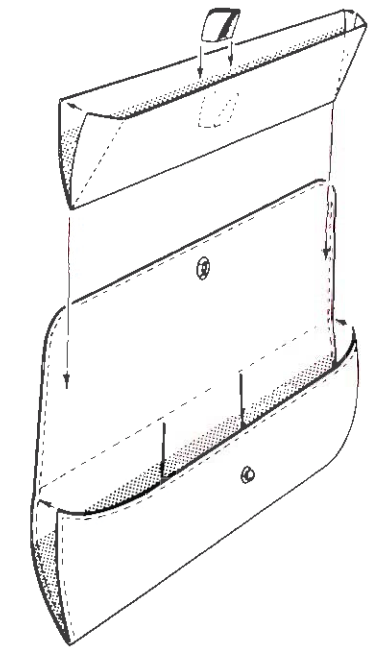
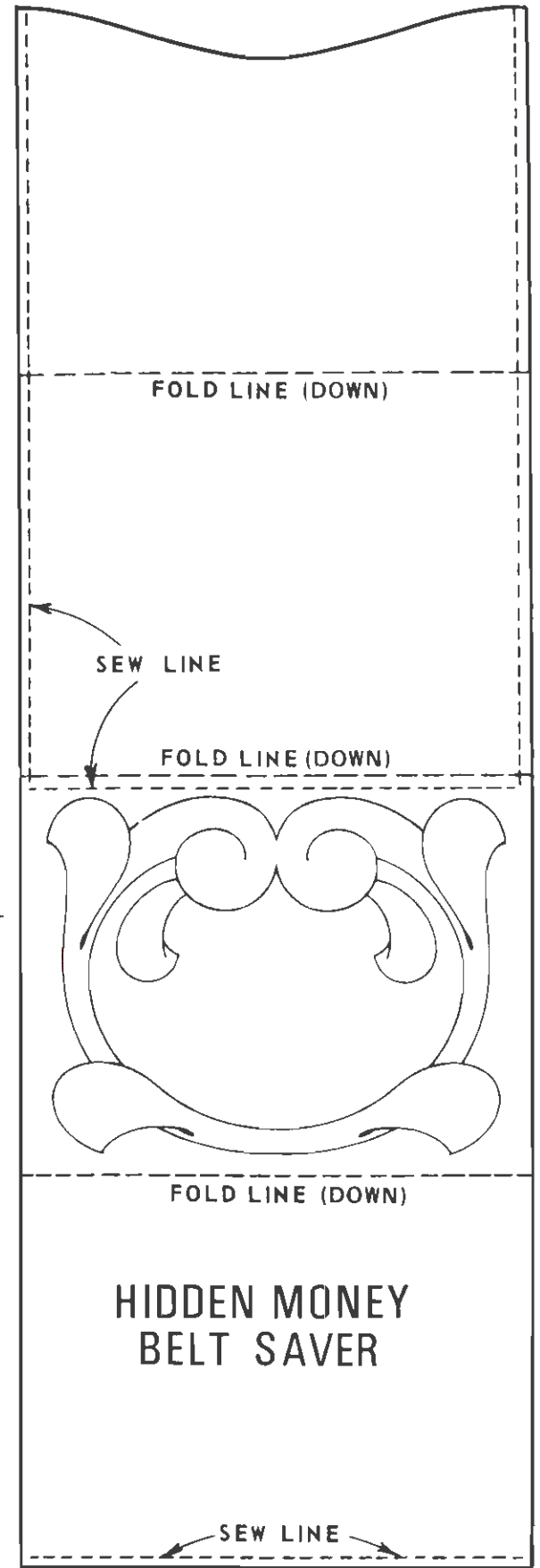
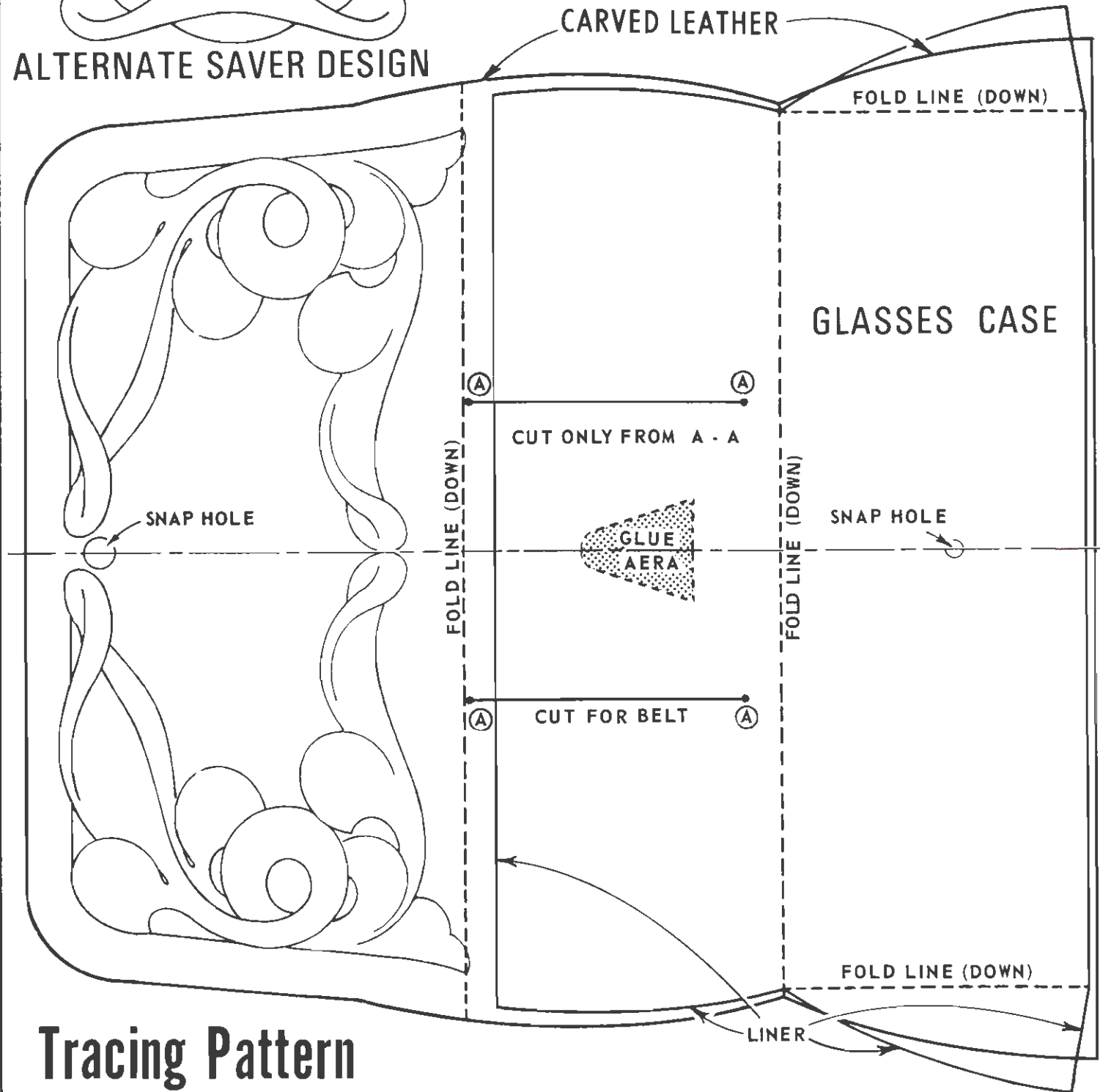

ASSEMBLING DETAIL

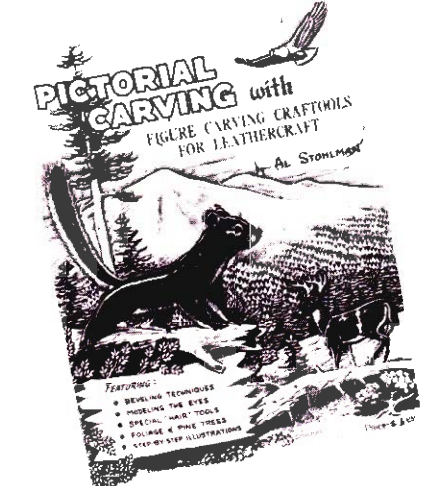
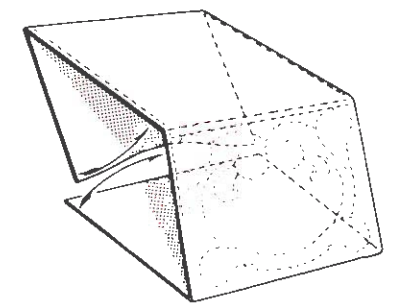

PICTORIAL CARVINGS

Only \$1.00 each

Book gives easy step-by-step instructions on use of basic figure carving tools. Shows how to carve animals, birds, flowers, scenery, technique for using Crafttools to achieve the effect of hair on your animals. Even a beginner can learn quickly how to do figure carving with this book. By Al Stohlman. 16 pgs. 8 1/2" x 11". 6037 PICTORIAL CARVING ... \$1.00 ea.



FIGURE CARVING

only \$2.00 each

Al Stohlman tells you exactly what tools to use and how to use them. Dyeing fully explained. Patterns for belts, billfolds, key cases, etc. included. Shows you how to carve fish, horses, birds, many other animals. 32 pages, 13 different chapters. Order your copy today. 6049 Figure Carving ... \$2.00 ea.

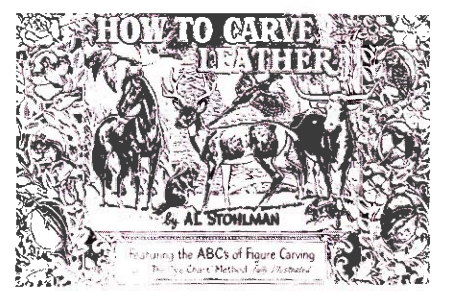

HOW TO CARVE LEATHER— by Al Stohlman. 48 big 18 1/2" x 12 1/2" pgs. How to assemble 11 projects. 30 illus. dye charts, 40 interchangeable Photocarve patterns, 6 complete alphabets (1/2" to 1 1/2" letters). 6047 ... \$3.50 ea.

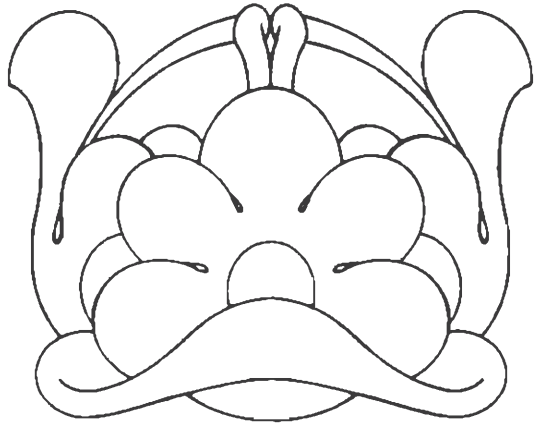

ALTERNATE SAVER DESIGN

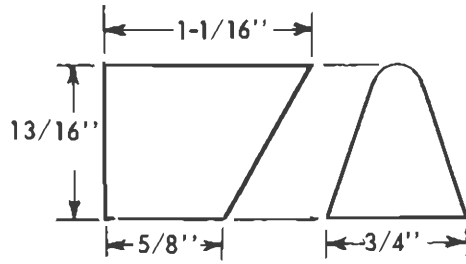

WOODEN SUPPORT

CARVED LEATHER

FOLD LINE (DOWN)

GLASSES CASE

CUT ONLY FROM A - A

CUT FOR BELT

GLUE AREA

SNAP HOLE

FOLD LINE (DOWN)

FOLD LINE (DOWN)

FOLD LINE (DOWN)

LINER

Tracing Pattern

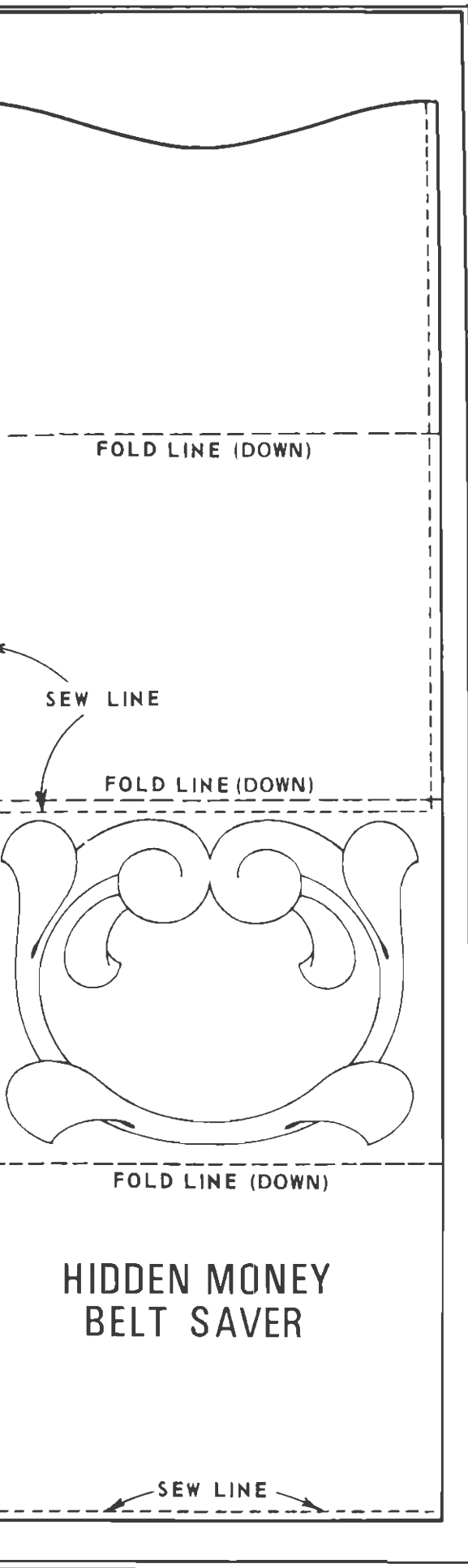

**HIDDEN MONEY  
BELT SAVER**

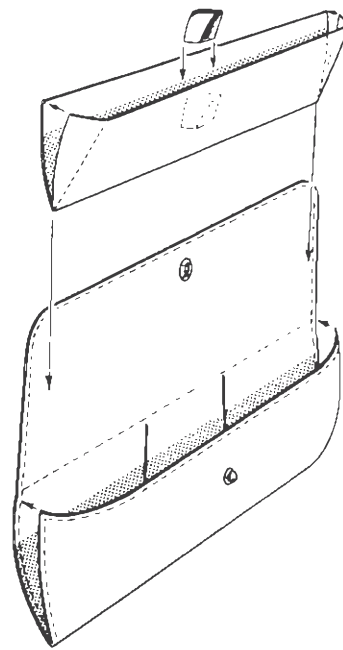

**ASSEMBLING DETAIL**

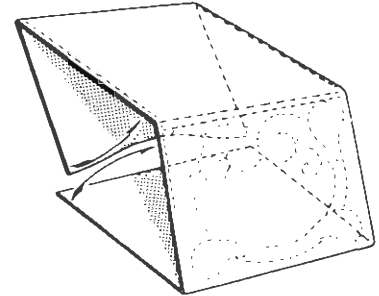

**PICTORIAL CARVINGS**

Only **\$1<sup>00</sup>** each

Book gives easy step-by-step instructions on use of basic figure carving tools. Shows how to carve animals, birds, flowers, scenery, technique for using Crafttools to achieve the effect of hair on your animals. Even a beginner can learn quickly how to do figure carving with this book. By Al Stohlman. 16 pgs. 8½" x 11".  
6037 PICTORIAL CARVING . . . \$1.00 ea.



**FIGURE CARVING**

only **\$2<sup>00</sup>** each

Al Stohlman tells you exactly what tools to use and how to use them. Dyeing fully explained. Patterns for belts, billfolds, key cases, etc. included. Shows you how to carve fish, horses, birds, many other animals. 32 pages, 13 different chapters. Order your copy today.  
6049 Figure Carving . . . . . \$2.00 ea.

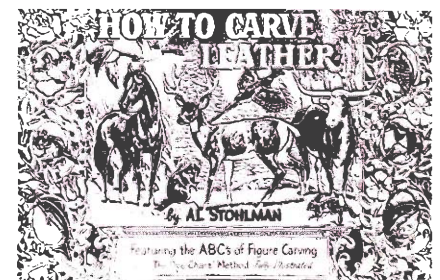

**HOW TO CARVE LEATHER**— by Al Stohlman. 48 big 18½" x 12½" pgs. How to assemble 11 projects. 30 illus. dye charts, 40 interchangeable Photocarve patterns, 6 complete alphabets (½" to 1½" letters).  
6047 . . . . . \$3.50 ea.