

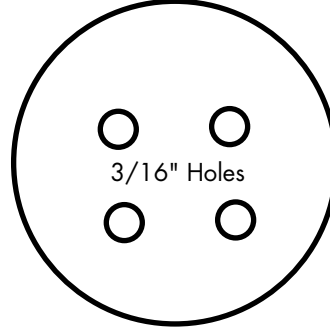

BACKPACK

Design by George Hurst. Pattern is reproduced at 100%.
Visit www.tandy.com for all the supplies needed to complete this project.
Visit www.LeadercraftLibrary.com for more great carving patterns.



LACE CLOSER
Cut from 8 to 9 oz.
vegetable tanned cowhide



FRONT AND BACK
CUT 1 EACH FROM
6 TO 7 OZ. VEGETABLE TANNED COWHIDE

PUNCH FOR FRONT ONLY

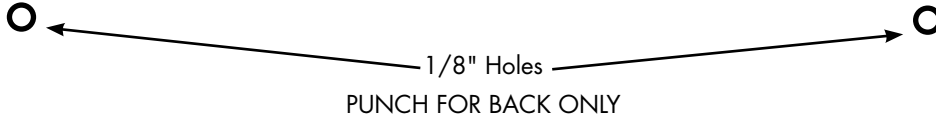

PUNCH FOR BACK ONLY

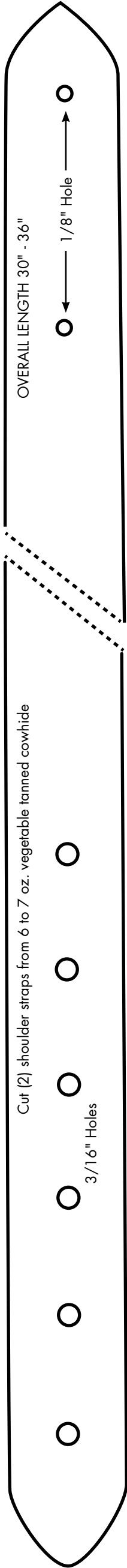
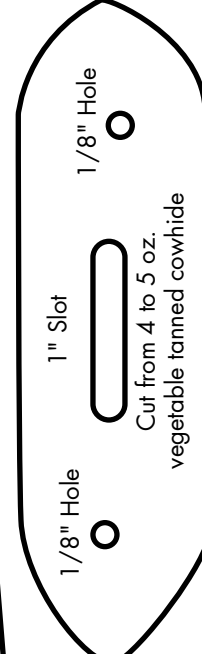
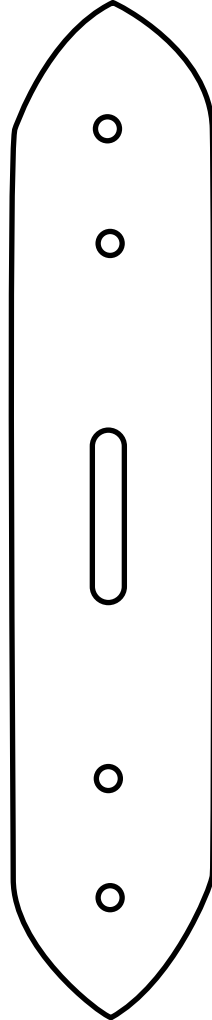
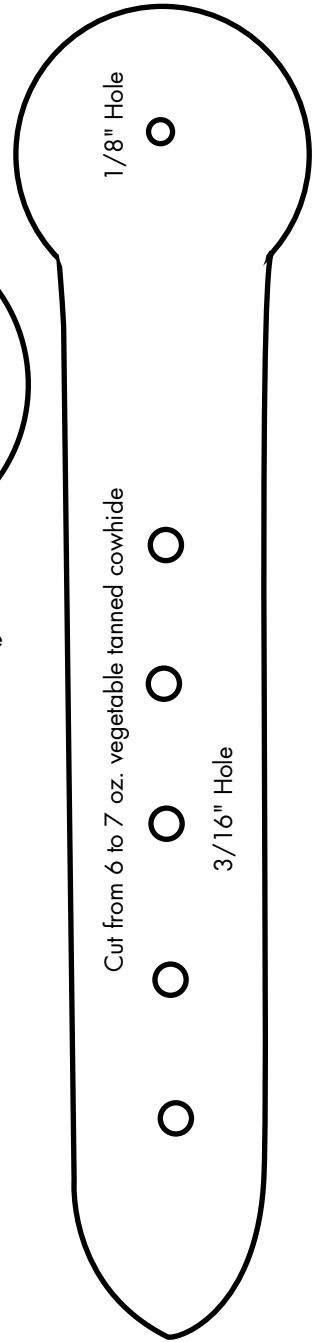

BACKPACK

Design by George Hurst. Pattern is
Visit www.tandy.com for all the supplies r
Visit www.LeadercraftLibrary.com for mor

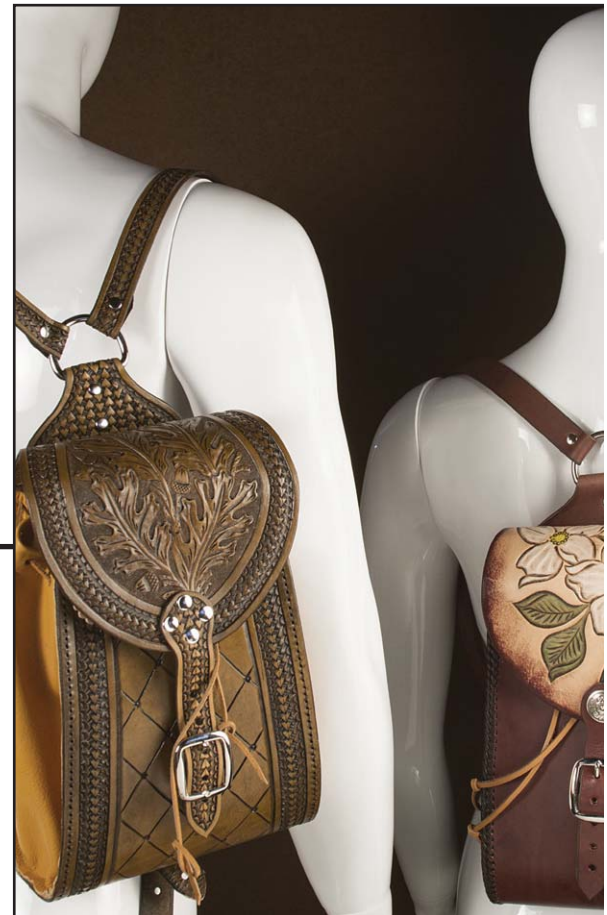

3/16" Hole

K
reproduced at 100%.
needed to complete this project.
re great carving patterns.

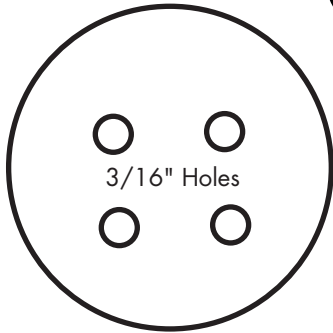
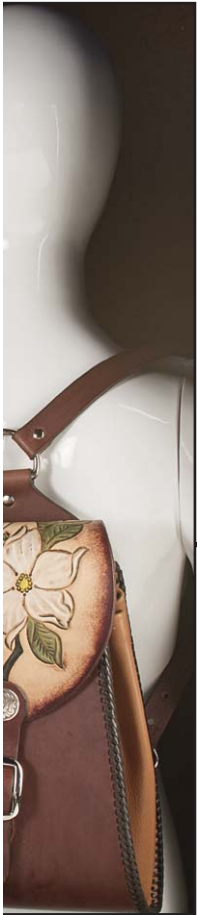

3/16" Holes

LACE CLOSER
Cut from 8 to 9 oz.
vegetable tanned cowhide



3/16" Hole

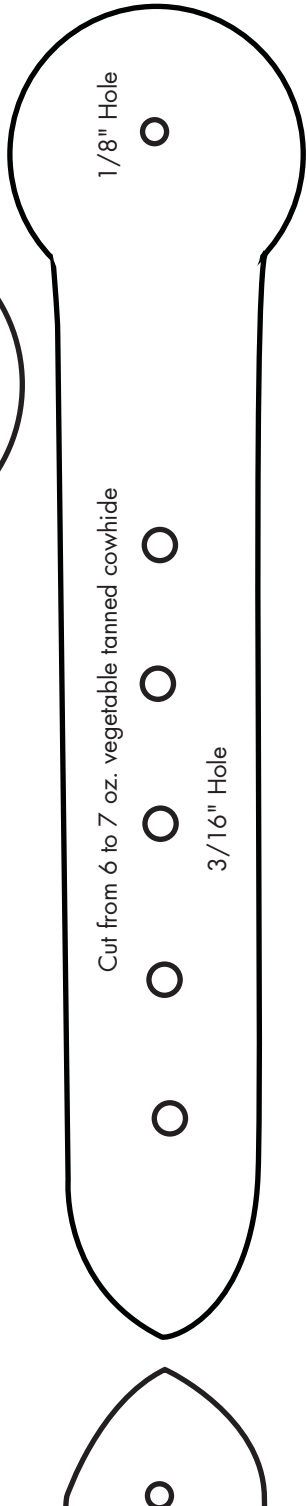

1/8" Hole

Cut from 6 to 7 oz. vegetable tanned cowhide

3/16" Hole

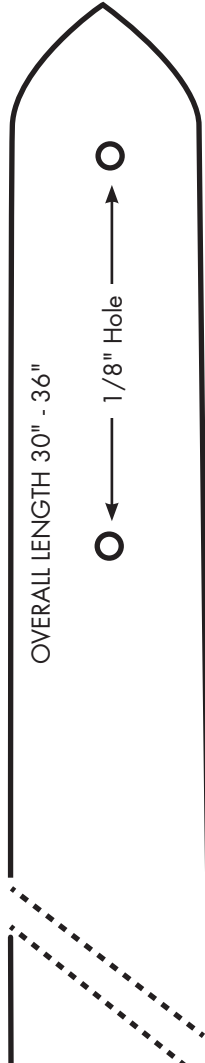

OVERALL LENGTH 30" - 36"

1/8" Hole

FRONT AND BACK
CUT 1 EACH FROM
6 TO 7 OZ. VEGETABLE TANNED COV

PUNCH FOR FRONT ONLY



1/8" Holes



1/8" Holes

PUNCH FOR BACK ONLY



W/WHITE

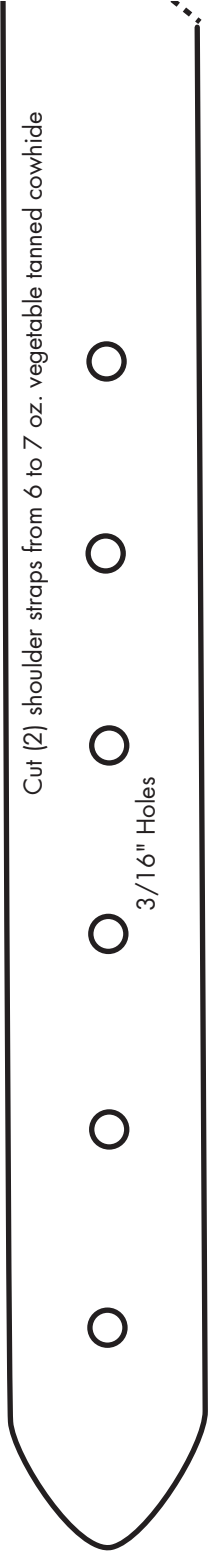
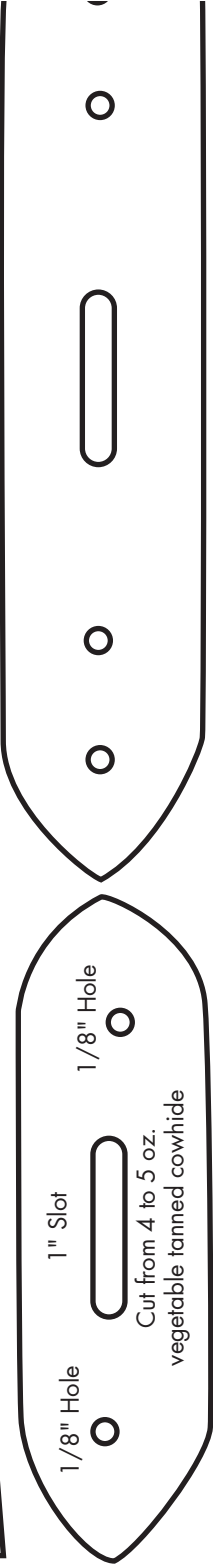
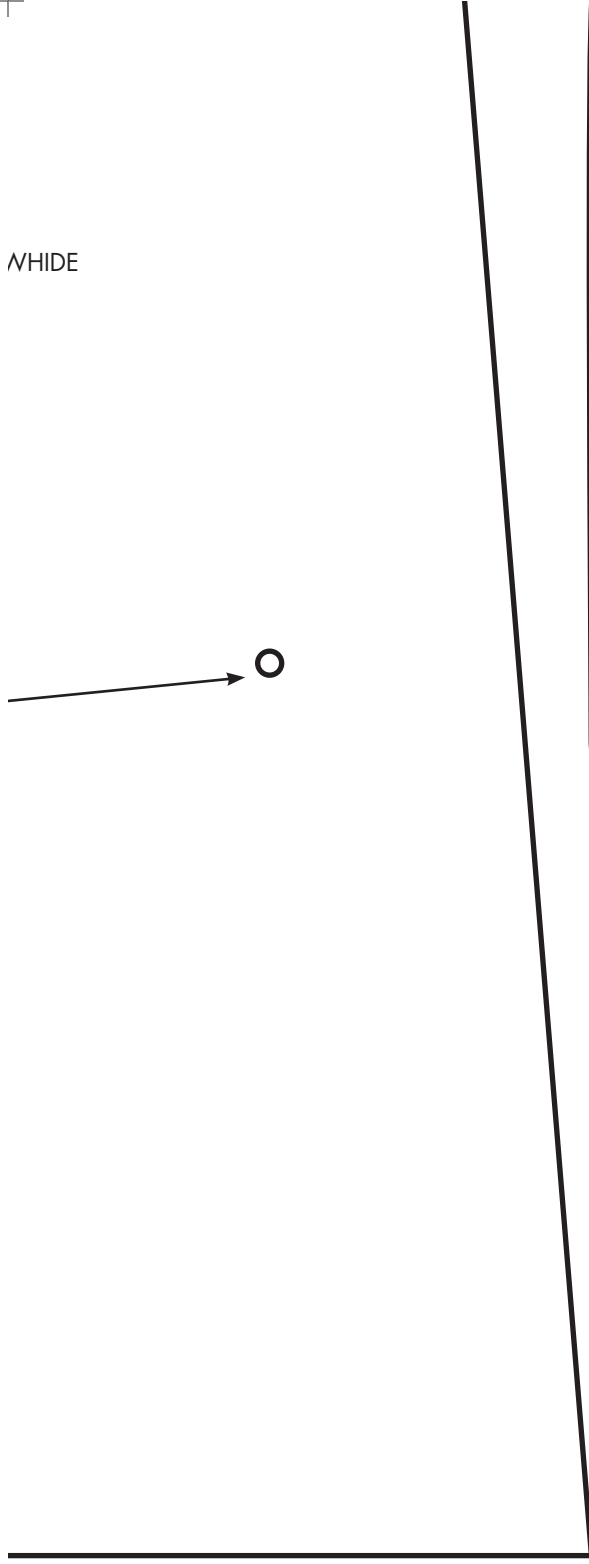

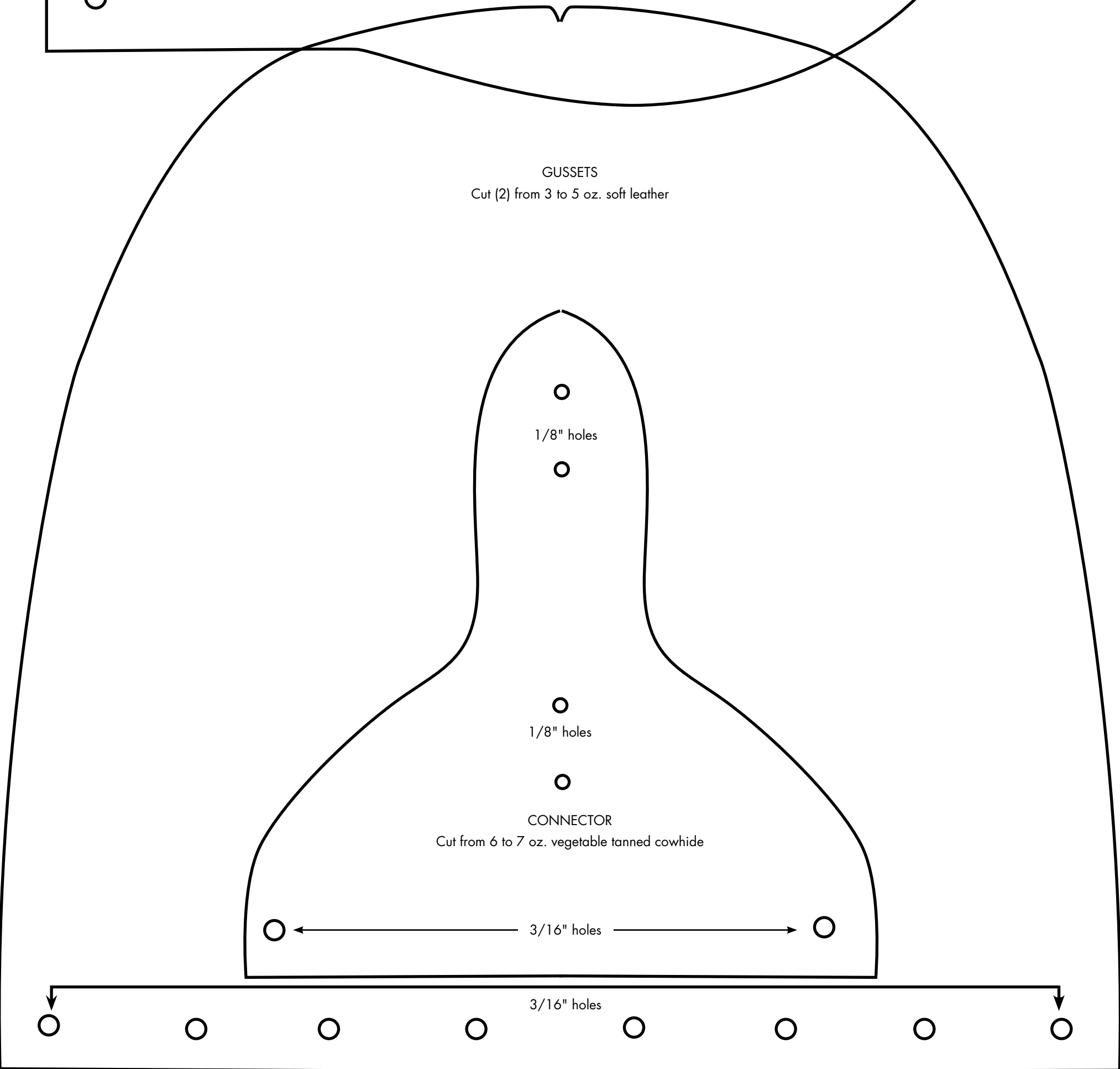
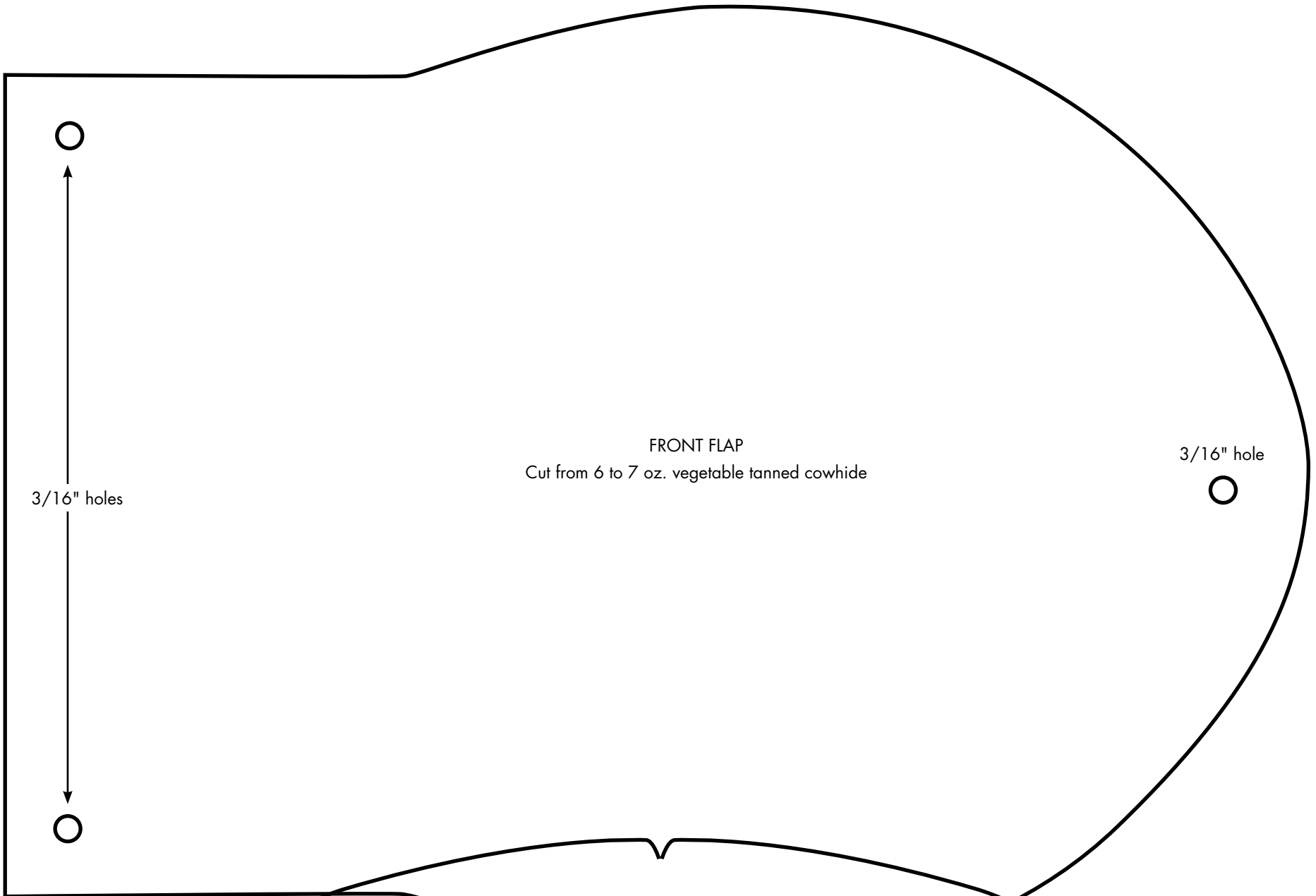

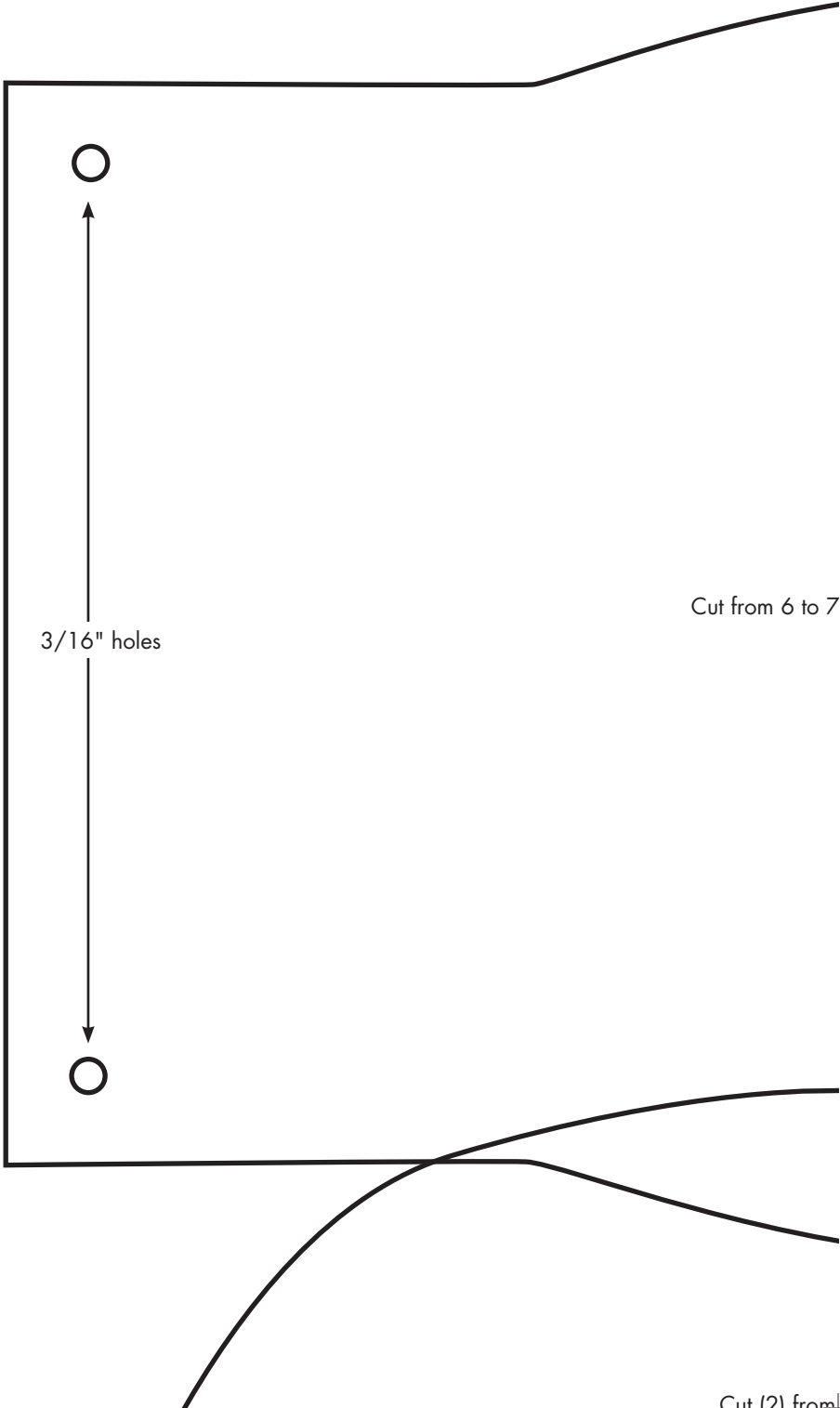

3/16" holes

Cut from 6 to 7

Cut (2) from

FRONT FLAP

1 oz. vegetable tanned cowhide

3/16" hole



GUSSETS

3 to 5 oz. soft leather



1

1/

CC

Cut from 6 to 7 oz

3/

3/

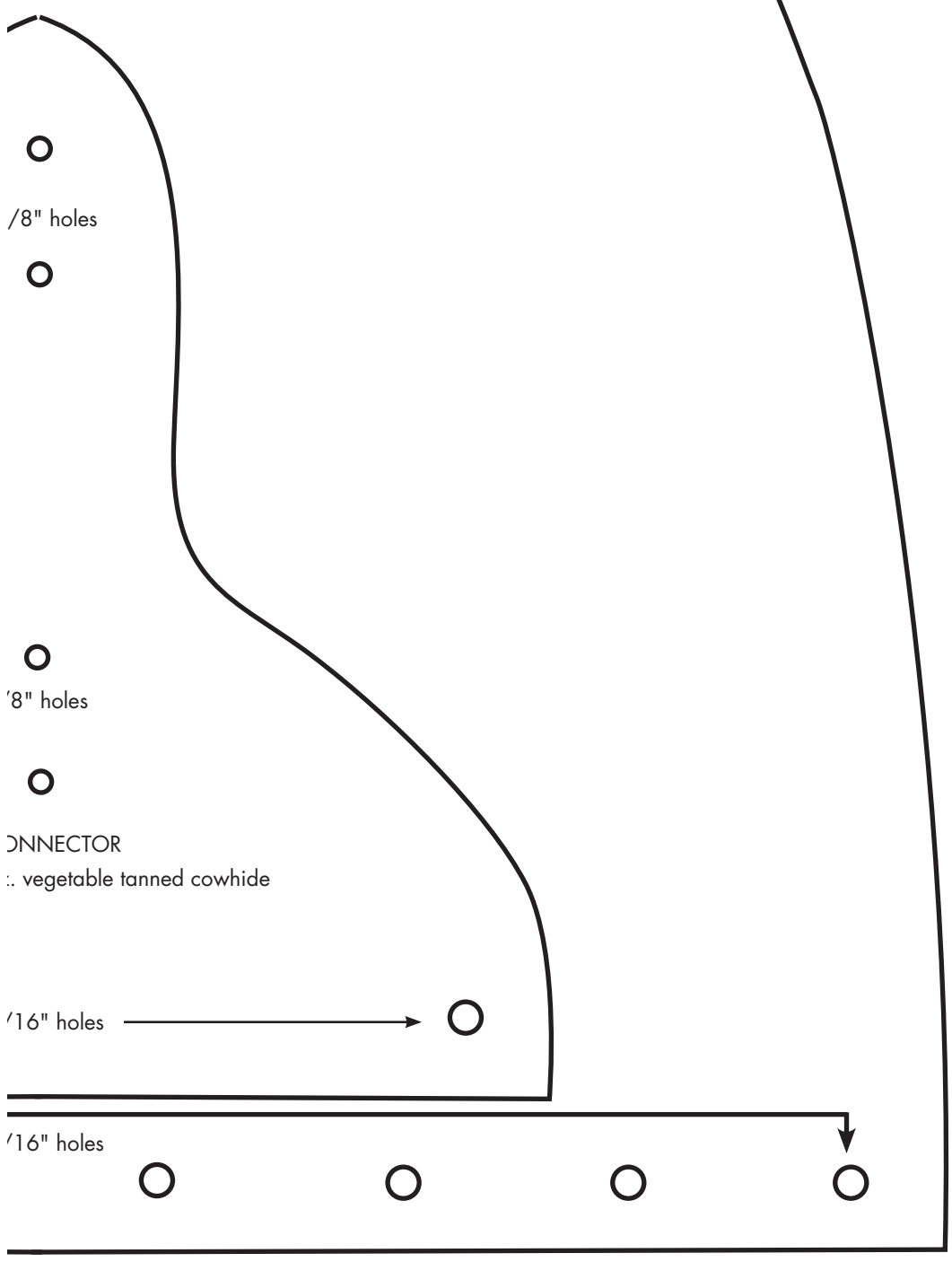

$\frac{1}{8}$ " holes

$\frac{1}{8}$ " holes

CONNECTOR
vegetable tanned cowhide

$\frac{1}{16}$ " holes →

$\frac{1}{16}$ " holes