

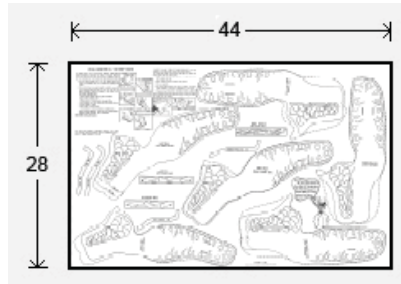

## Pattern Digital Download

This PDF file contains 1 (one) full pattern package. The PDF has been put together to give you options when it comes to printing. Pages and patterns that are larger than 8½x11 have been provided in two formats:



### 1) Full Size

If you would like to have a full size print out, take the full size pages to your local print shop and they can print it for you.

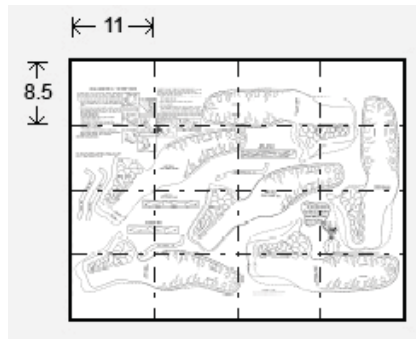

### 2) Tiled

The tiled pages give you the option of printing the larger patterns at home. You print the tiled pages and then assemble them to make the larger patterns.

The pattern PDF files are typically laid out like this:

Cover(if applicable), instructions sheets (if applicable), pattern 1 – full sized, pattern 1 – tiled, pattern 2 – full sized, pattern 2 – tiled, pattern 3 – full sized, pattern 3 – tiled ....etc

Please note: When printing on a home printer, use the settings seen on the image to the right in the Page Handling area of the Adobe Reader print dialogue box. If your printer is cutting edges off, set “Page Scaling” to “Shrink to Printable Area”. This will, however, decrease the size of the pattern a very small amount.

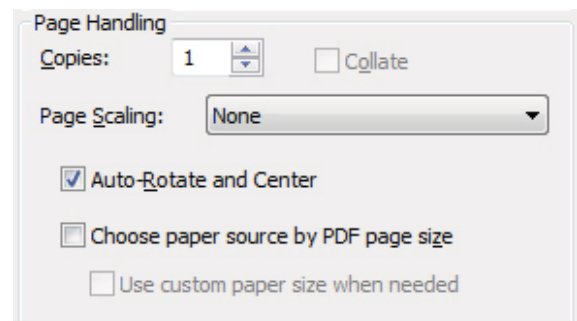

You may take this PDF file to your local print shop to have the full-size pages printed for your own personal use.



## HOW TO ASSEMBLE INDIAN VEST

The "wrong side" of the Moccasin suede leather is the side containing the footage markings. Be sure to make all markings, tracings, etc., on the "wrong side".

1. Cut out paper pattern for size desired.
2. Fit pattern on model and make necessary adjustments in length.
3. Lay all pattern pieces on the leather before you start cutting to get best cutting plan. Since all skins vary in size and shape, each skin will require a slightly different cutting layout. Be sure to allow for two front pieces and two pockets.
4. Cut fringe and buttons from scraps of leather. See how to make buttons on reverse side.
5. When all pieces have been properly placed on the skin, proceed to cut leather. Use the leather knife included in the kit or a pair of good shears.
6. Use a soft lead pencil to measure and mark lacing holes across the shoulders and down the side seams. There should be an even number of holes in each seam. Holes should be spaced approximately  $\frac{1}{2}$ " apart and approximately  $\frac{1}{4}$ " from edge of leather. Use pattern as a guide to be sure holes match.
7. Punch holes in sides and across shoulders. Use an ordinary paper punch or a good leather punch.
8. Lap sides over from front to back.
9. Knot one end of a piece of lace. Use a running stitch starting with the knot on the outside and lace in and out holes. End by knotting lace at last hole.
10. Lace shoulders the same as the sides. Lap shoulders over from back to front. If fringe is to be added, lace fringe and shoulder seams at the same time.

### POCKET

11. Use pocket pattern to carefully mark lacing holes on leather pockets. Punch holes in pockets.
12. Lay leather pocket on vest and mark lacing holes on vest. Punch holes and lace pockets to vest. If fringe is to be added, lace fringe to pocket before lacing pocket to vest.
13. Fit vest on model and mark darts at waistline as indicated on the pattern in back of vest. Vest should fit smoothly across back. Punch holes and lace in darts.

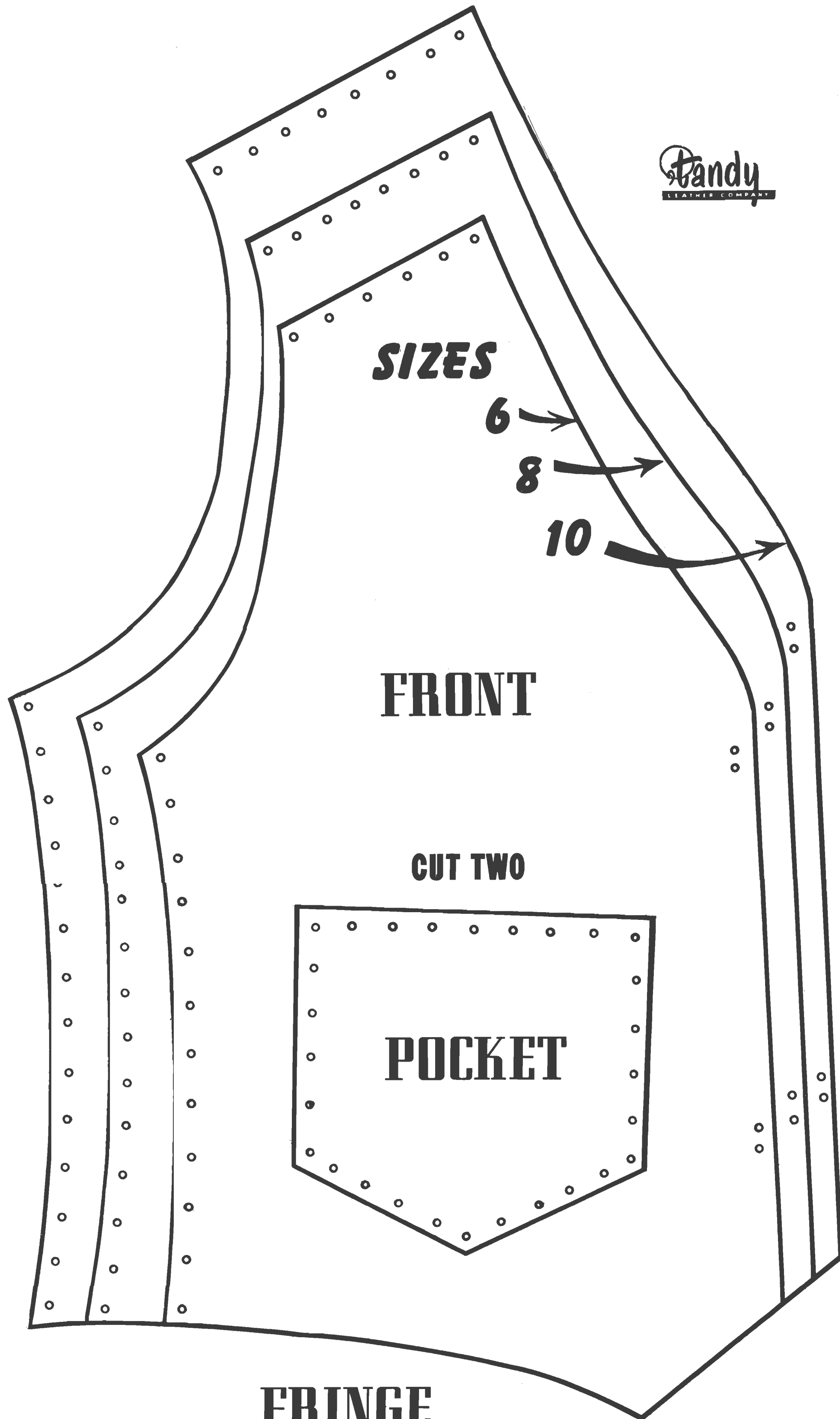
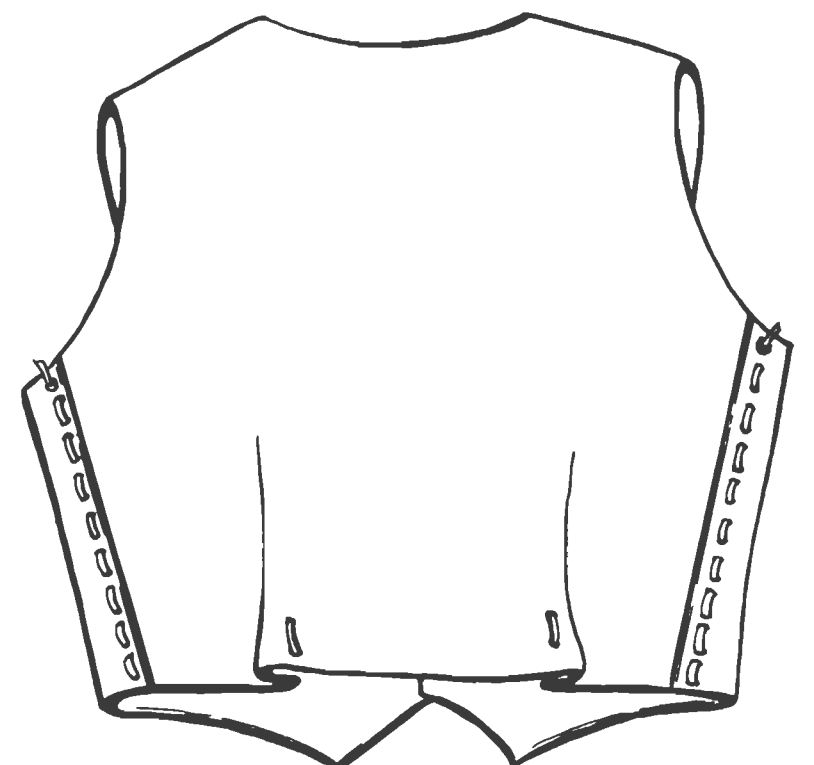
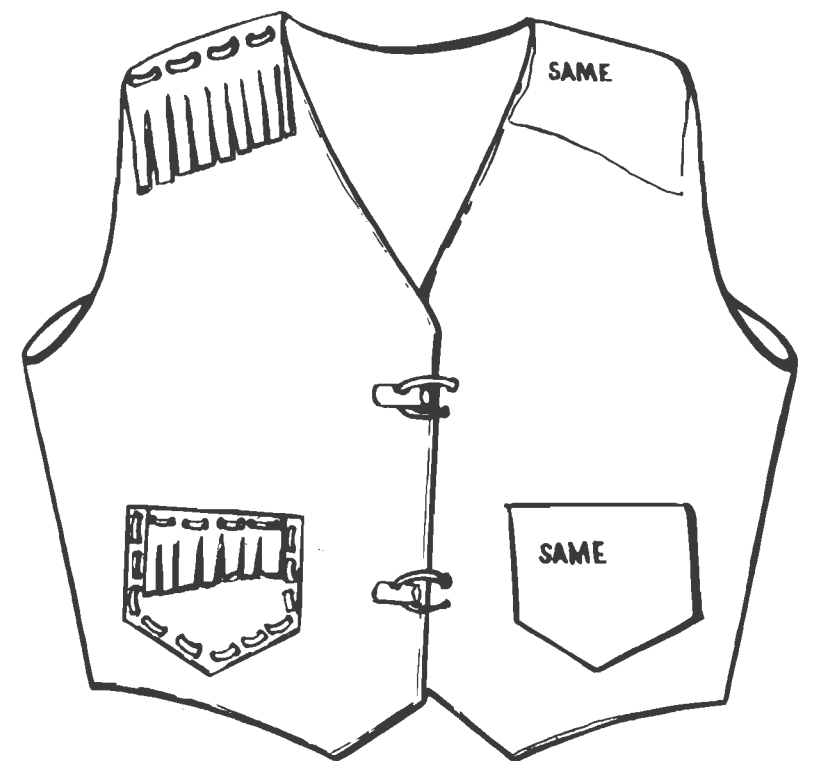

## FRINGE

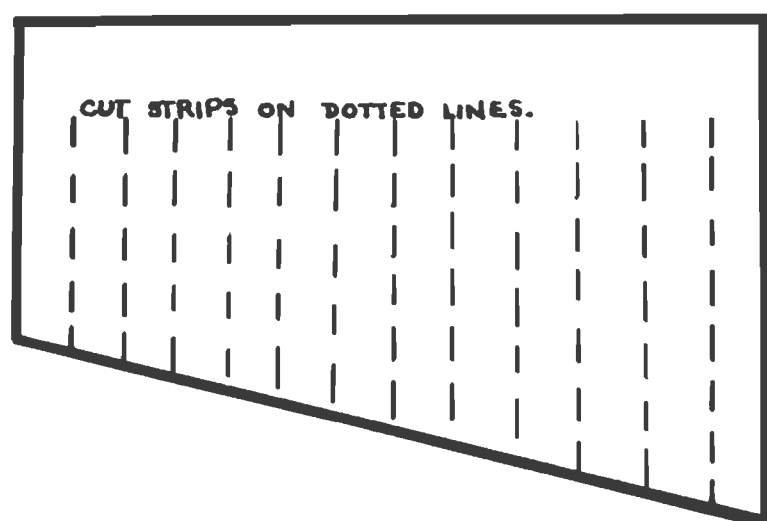

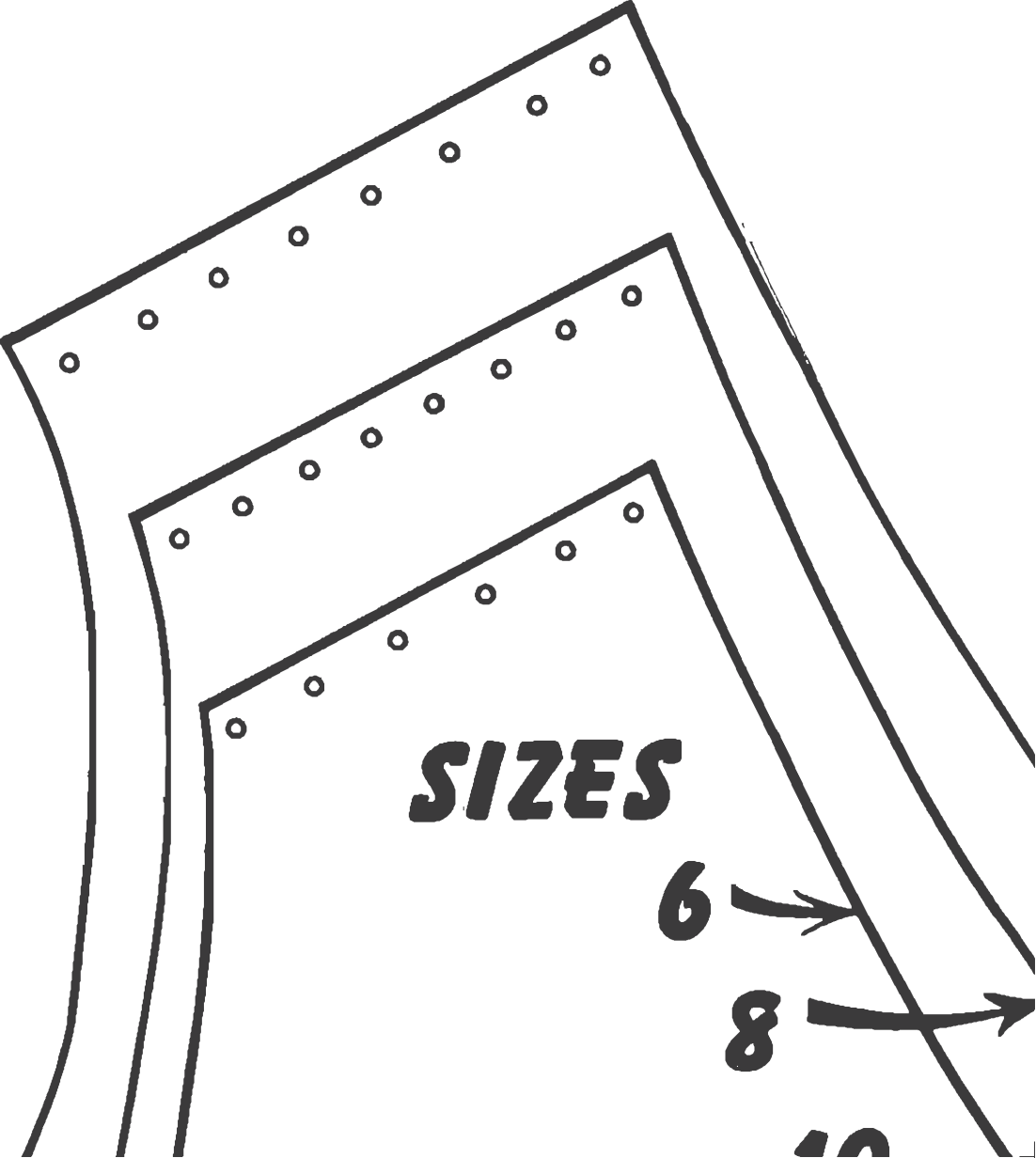

***SIZES***

**6**



**8**



**10**



## HOW TO ASSEMBLE INDIAN VEST

The "wrong side" of the Moccasin suede leather is the side containing the footage markings. Be sure to make all markings, tracings, etc., on the "wrong side".

1. Cut out paper pattern for size desired.
2. Fit pattern on model and make necessary adjustments in length.
3. Lay all pattern pieces on the leather before you start cutting to get best cutting plan. Since all skins vary in size and shape, each skin will require a slightly different cutting layout. Be sure to allow for two front pieces and two pockets.
4. Cut fringe and buttons from scraps of leather. See how to make buttons on reverse side.
5. When all pieces have been properly placed on the skin, proceed to cut leather. Use the leather knife included in the kit or a pair of good shears.
6. Use a soft lead pencil to measure and mark lacing holes across the shoulders and down the side seams. There should be an even number of holes in each seam. Holes should be spaced approximately  $\frac{1}{2}$ " apart and approximately  $\frac{1}{4}$ " from edge of leather. Use pattern

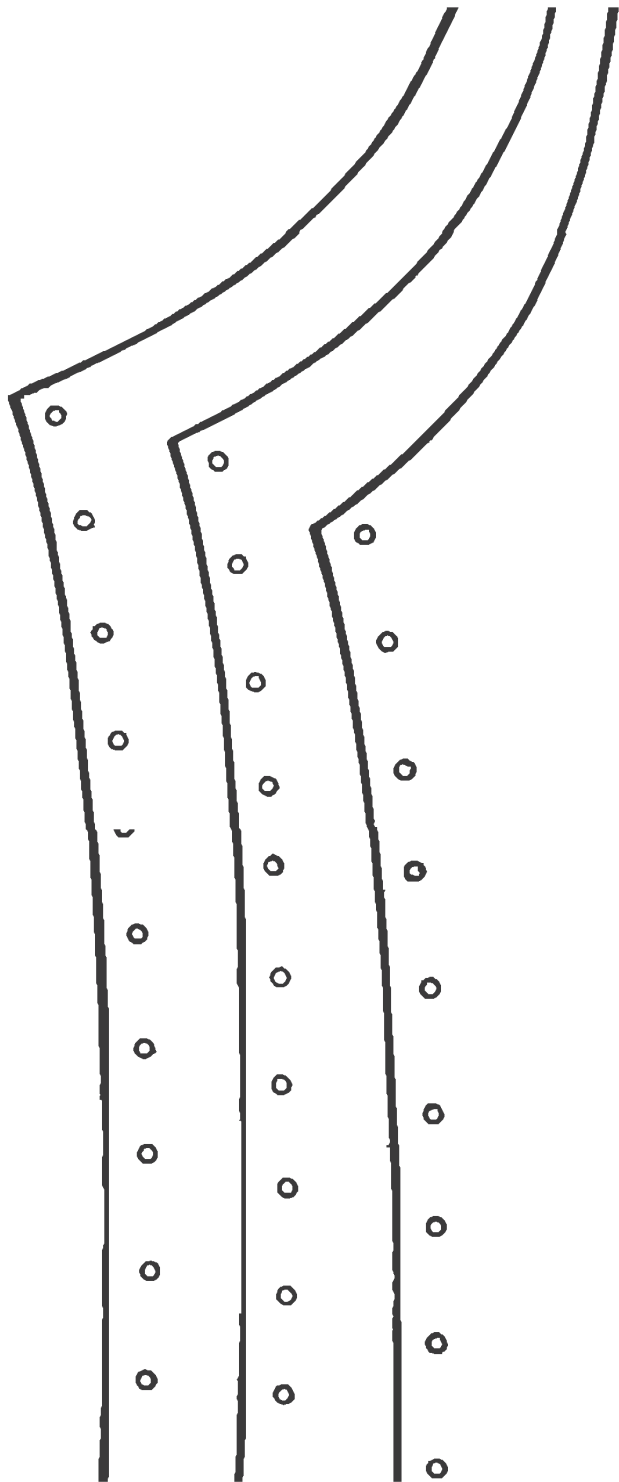

**FRONT**

**CUT TWO**



**POCKET**

approximately 4" from edge of shoulder. Use pattern as a guide to be sure holes match.

7. Punch holes in sides and across shoulders. Use an ordinary paper punch or a good leather punch.
8. Lap sides over from front to back.
9. Knot one end of a piece of lace. Use a running stitch starting with the knot on the outside and lace in and out holes. End by knotting lace at last hole.
10. Lace shoulders the same as the sides. Lap shoulders over from back to front. If fringe is to be added, lace fringe and shoulder seams at the same time.

POCKET

11. Use pocket pattern to carefully mark lacing holes on leather pockets. Punch holes in pockets.
12. Lay leather pocket on vest and mark lacing holes on vest. Punch holes and lace pockets to vest. If fringe is to be added, lace fringe to pocket before lacing pocket to vest.
13. Fit vest on model and mark darts at waistline as indicated on the pattern in back of vest. Vest should fit smoothly across back. Punch holes and lace in darts.

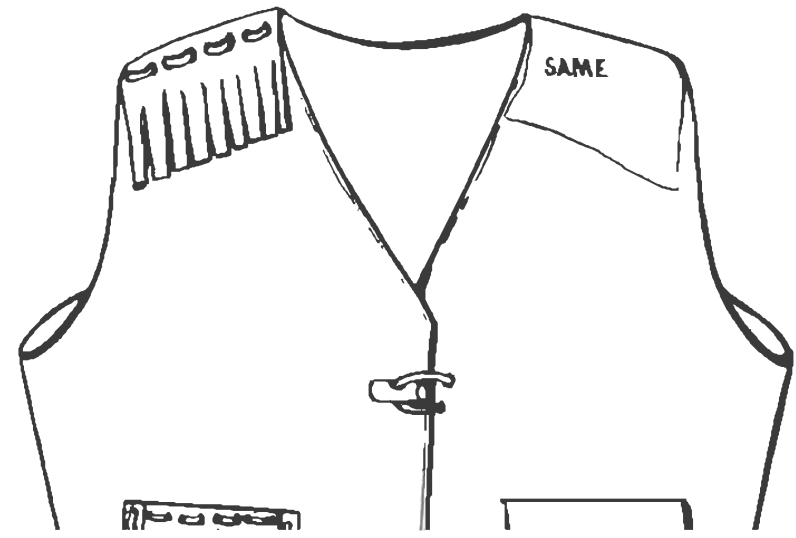
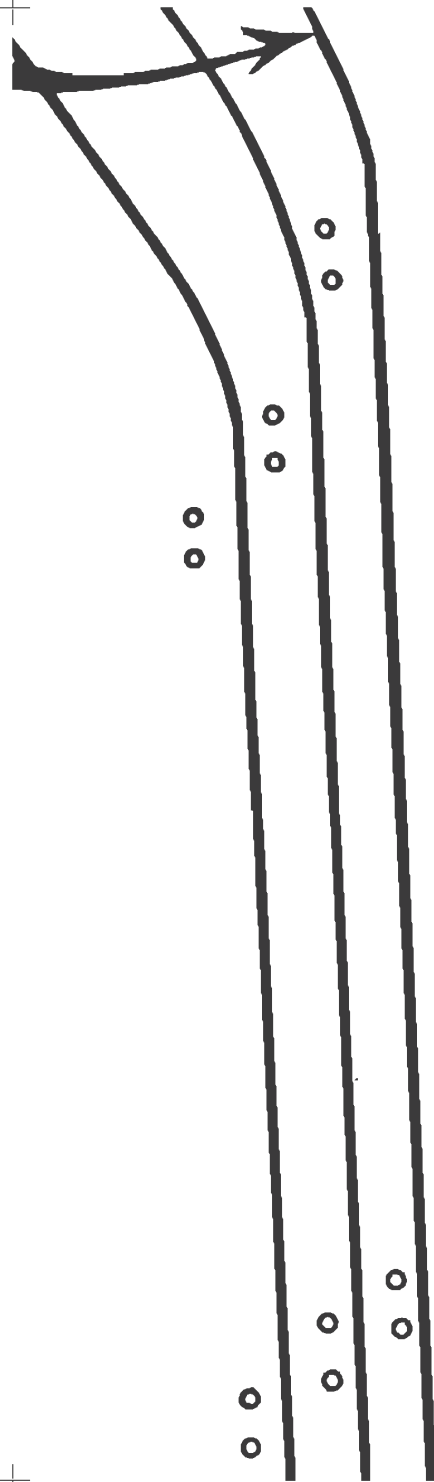

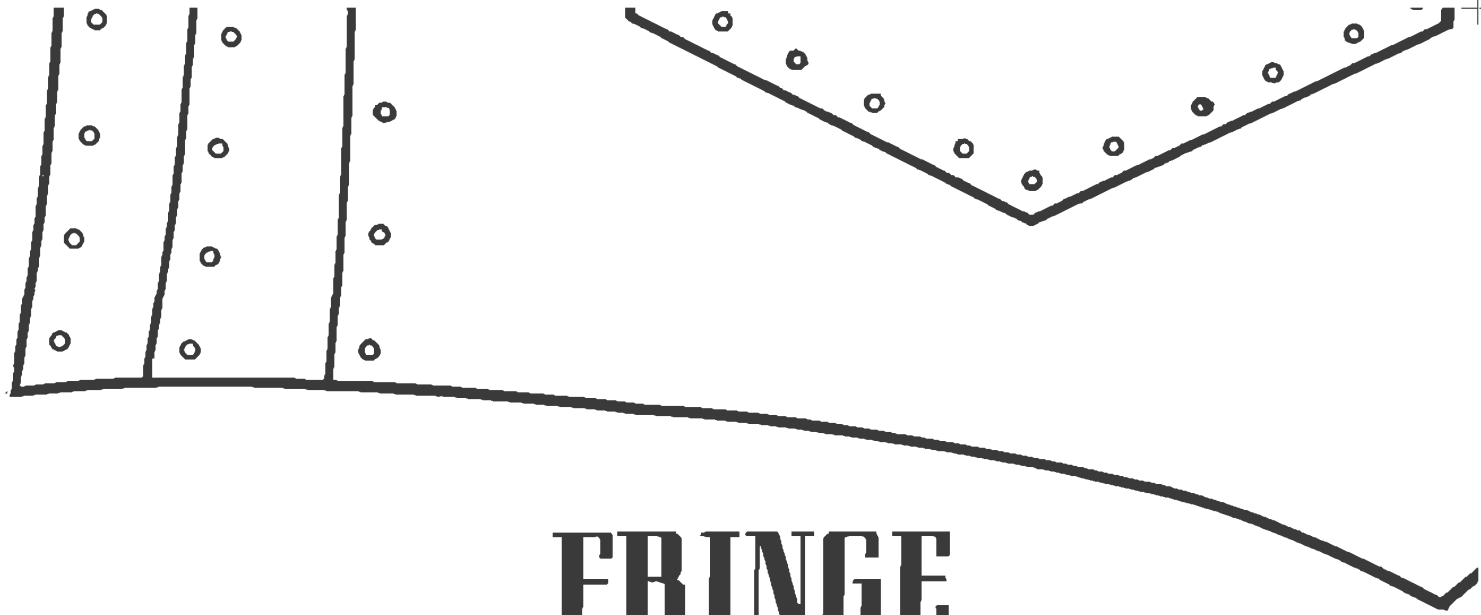

# FRINGE

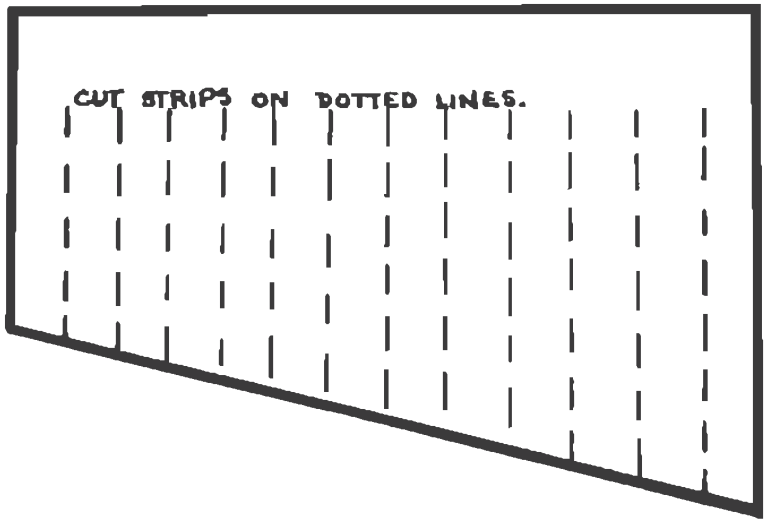

PRINTED IN USA

(No part of this or any other page may be re-printed without written permission.)

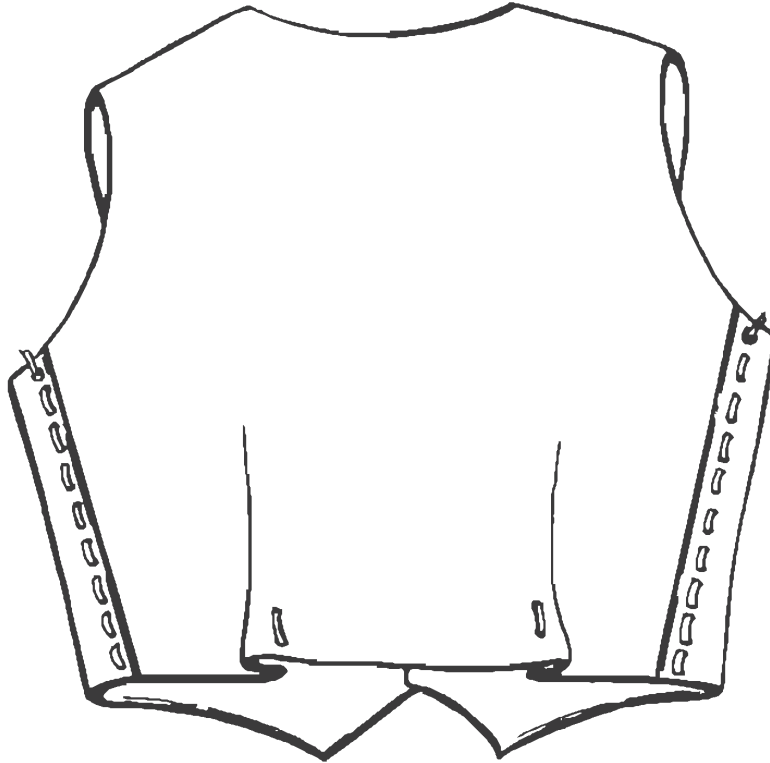
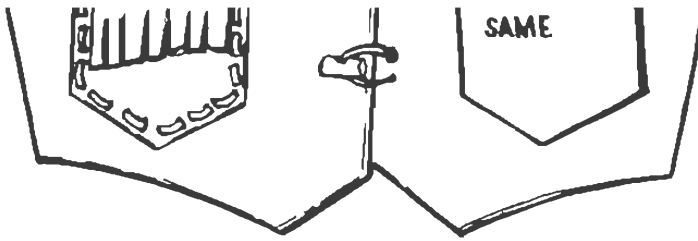
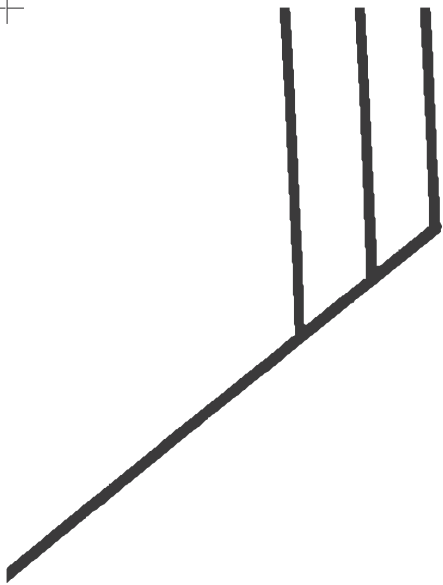



# INDIAN VEST PATTERN

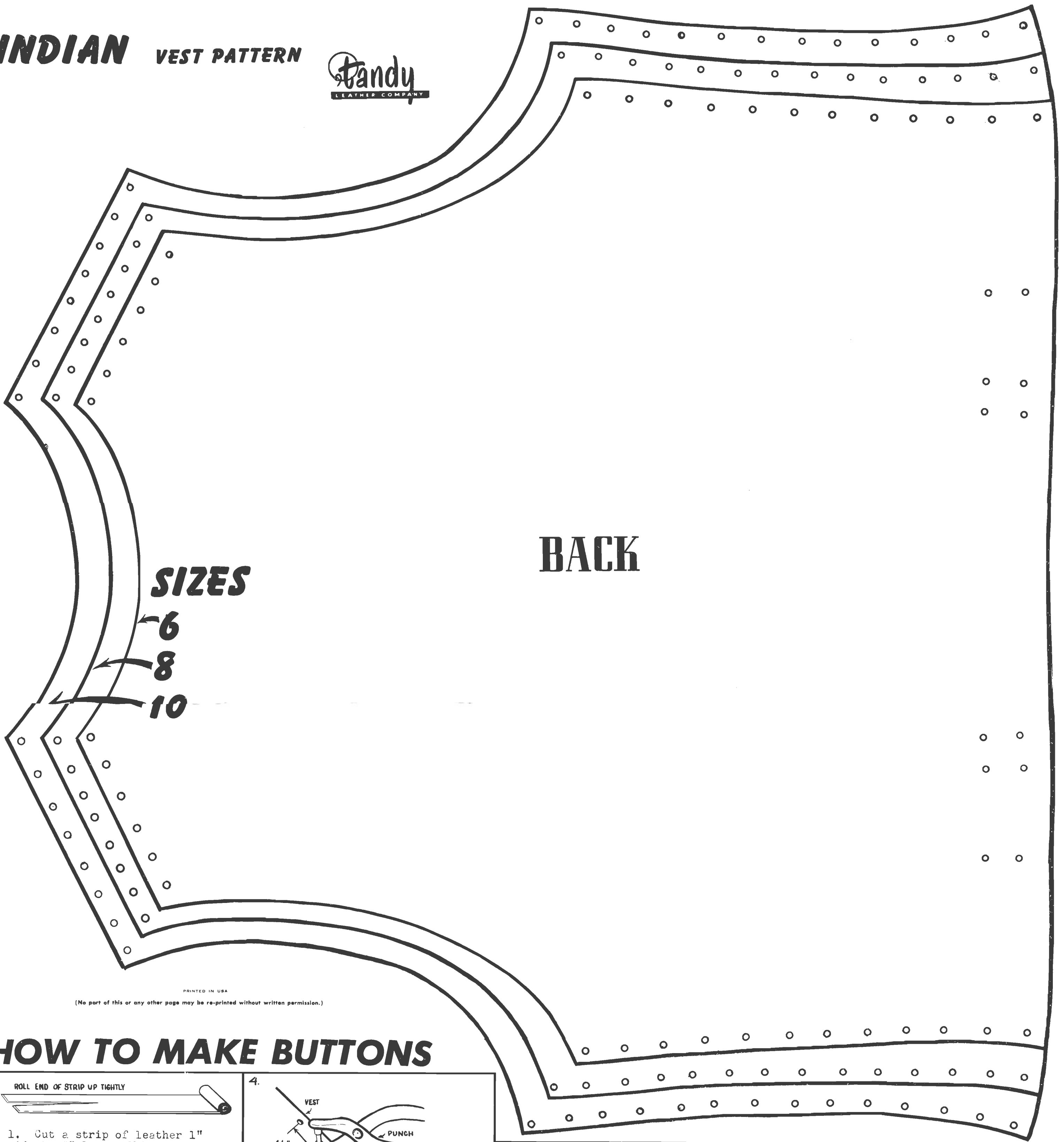

## SIZES

6  
8  
10

PRINTED IN USA

(No part of this or any other page may be re-printed without written permission.)

## HOW TO MAKE BUTTONS

<p><b>1.</b> ROLL END OF STRIP UP TIGHTLY</p> <p>1. Cut a strip of leather 1" wide by 5" long. Make a slit 2" from one end of strip. Tightly roll strip. (See Illus. 1)</p>	<p><b>4.</b></p> <p>4. Decide where buttons should go. Punch two holes <math>\frac{1}{2}</math>" apart (<math>\frac{1}{4}</math>" from edge) for each button.</p>
<p><b>2.</b></p> <p>2. Punch hole through center of roll using a paper punch or leather punch.</p>	<p><b>5.</b></p> <p>5. Put strips through holes so that strips are on the inside of vest. Tie strips together tightly on the inside of vest.</p>
<p><b>3.</b></p> <p>3. Bring one of the strips up and through hole in roll.</p>	<p><b>6.</b></p> <p>6. If you have any lacing left over, use it for a button loop. Otherwise, cut a strip from scrape leather. Put strips through holes in vest. Do not pull tightly; leave enough so that lace will loop over button.</p>
<p><b>7.</b></p> <p>7. Tie a knot at the end of each strip.</p>	

# **INDIAN VEST PATTERN**

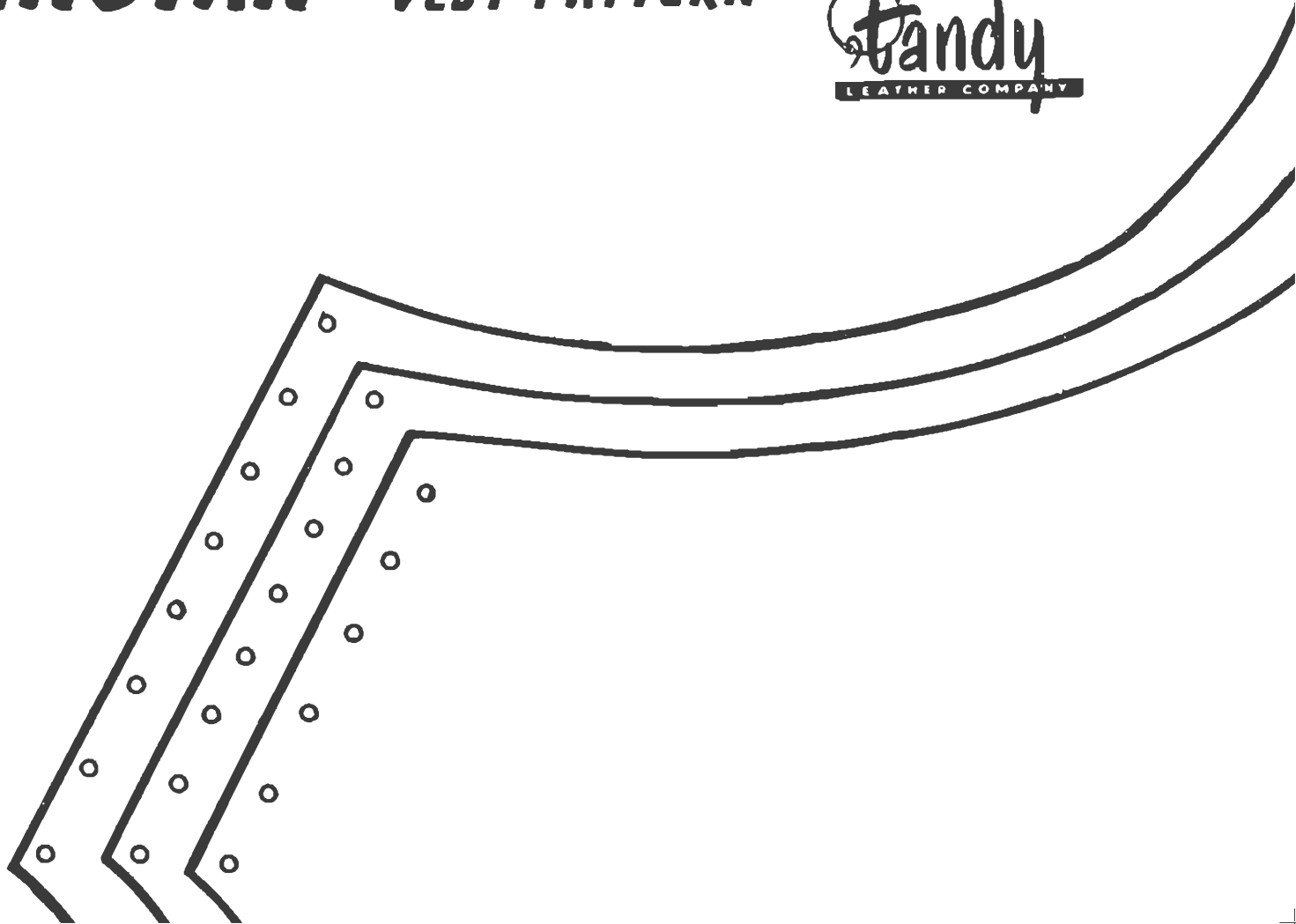

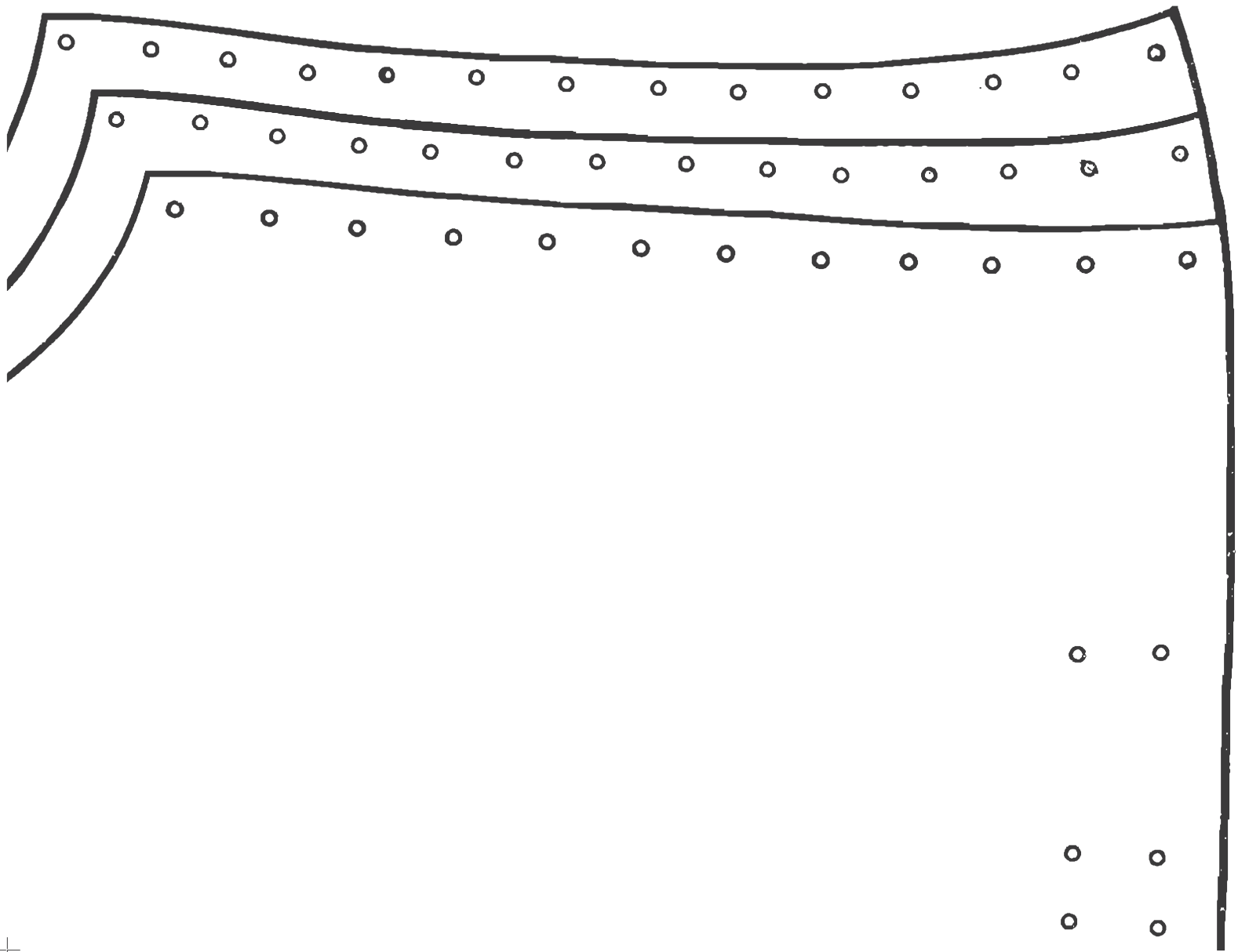

# ***SIZES***

← **6**

← **8**

← **10**

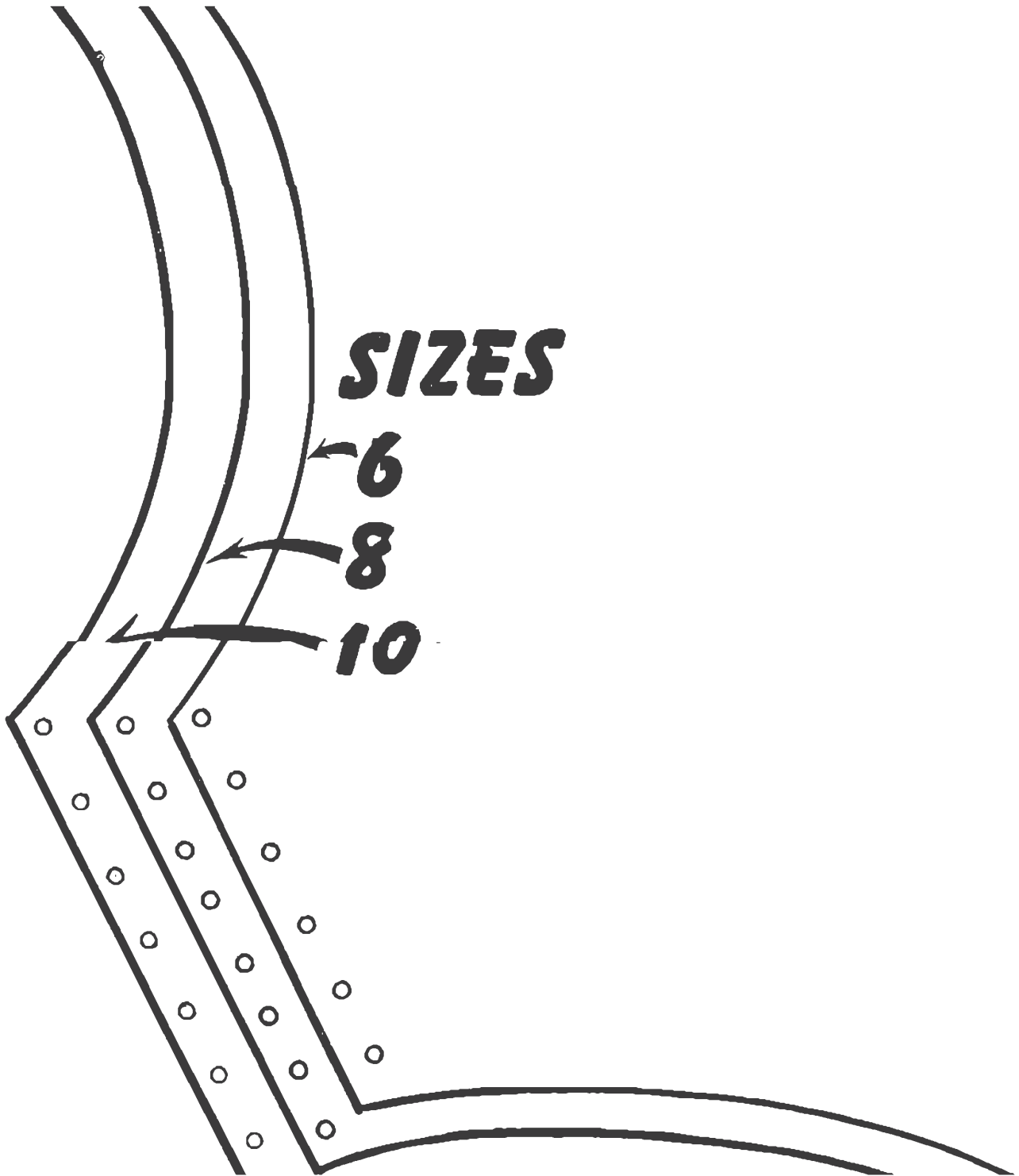

**BACK**



(No part of this or any other page may be re-printed without written permission.)

# HOW TO MAKE BUTTONS

1. ROLL END OF STRIP UP TIGHTLY

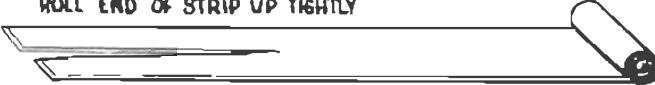

1. Cut a strip of leather 1" wide by 5" long. Make a slit 2" from one end of strip. Tightly roll strip. (See Illus. 1)

2.

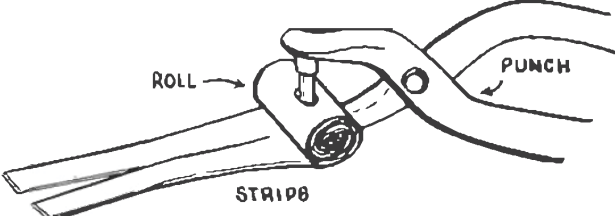

2. Punch hole through center of roll using a paper punch or leather punch.

3. PUT END OF ONE STRIP THROUGH HOLE IN ROLL

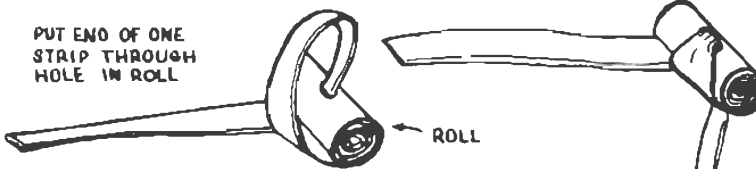

3. Bring one of the strips up and through hole in roll.

4.

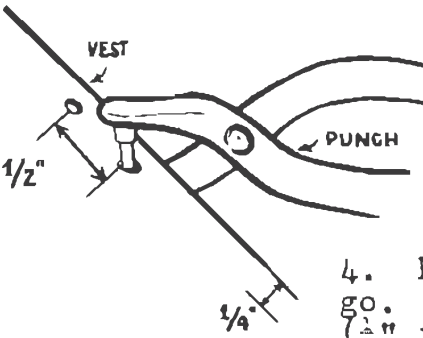

4. Decide where button goes. Punch two holes ( $\frac{1}{4}$ " from edge) for

5.

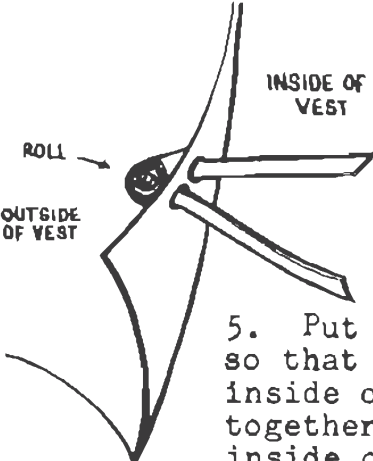

5. Put strips through holes so that strips are on the inside of vest. Tie strips together tightly on the inside of vest.

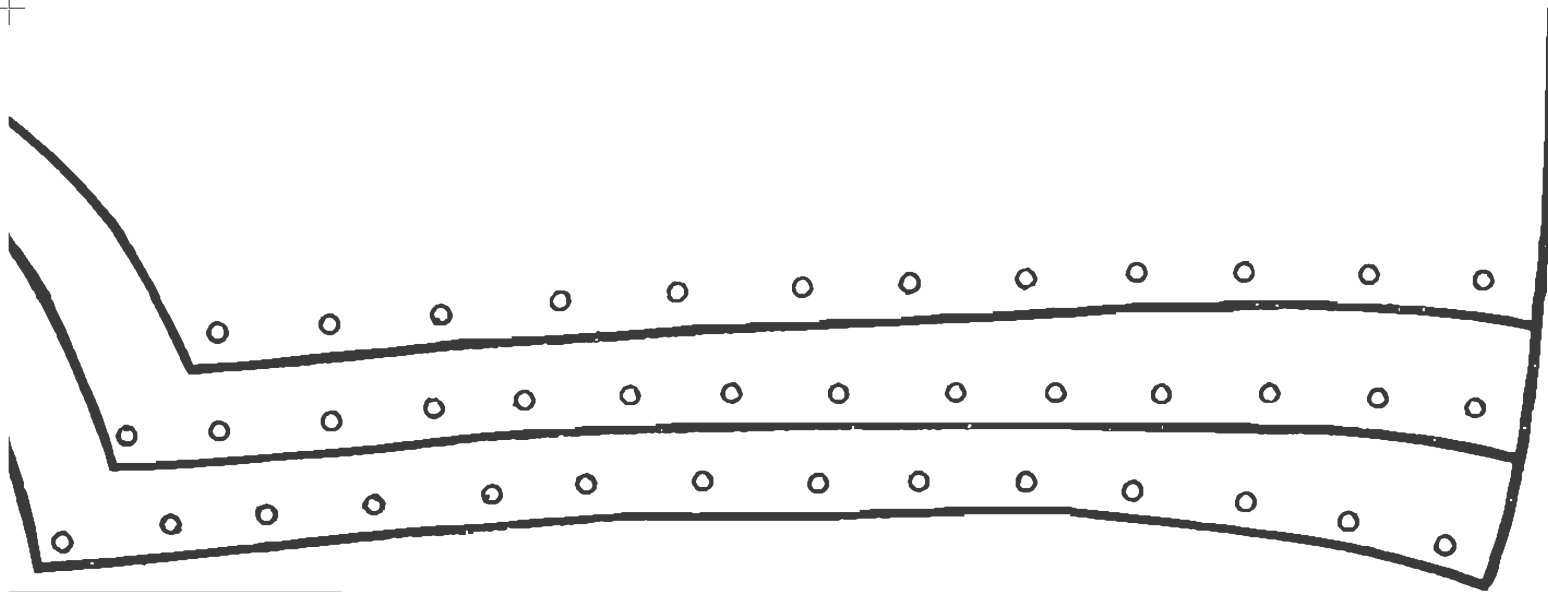

Buttons should be  $\frac{1}{2}$ " apart between each button.

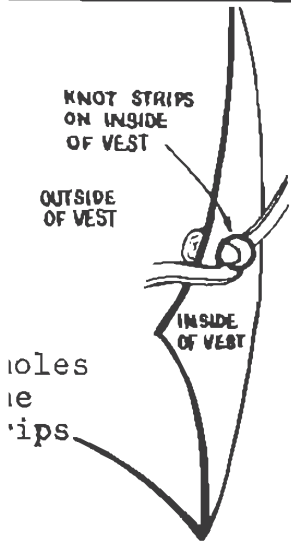

6

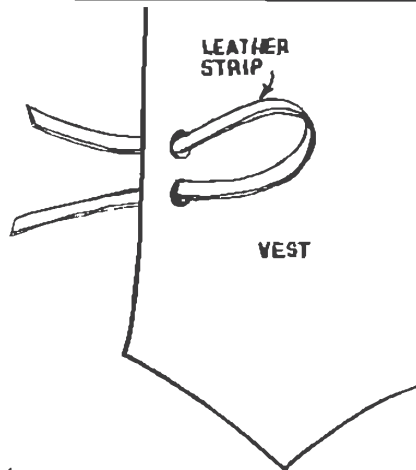

6. If you have any lacing left over, use it for a button loop. Otherwise, cut a strip from scrape leather. Put strips through holes in vest. Do not pull tightly; leave enough so that lace will loop over button.

7.

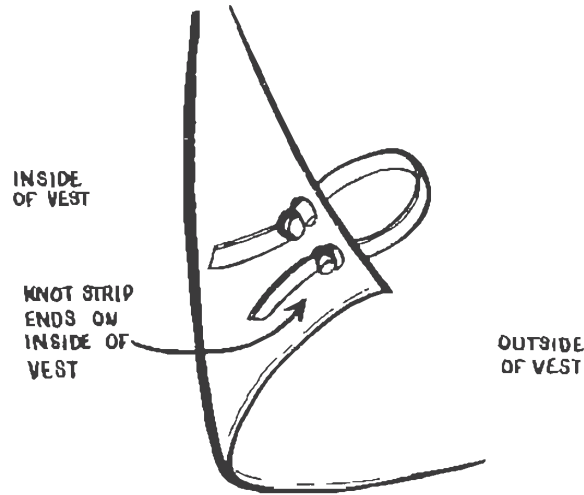

7. Tie a knot at the end of each strip.