

Men's Top Coat Pattern

Size 38

No. 2665

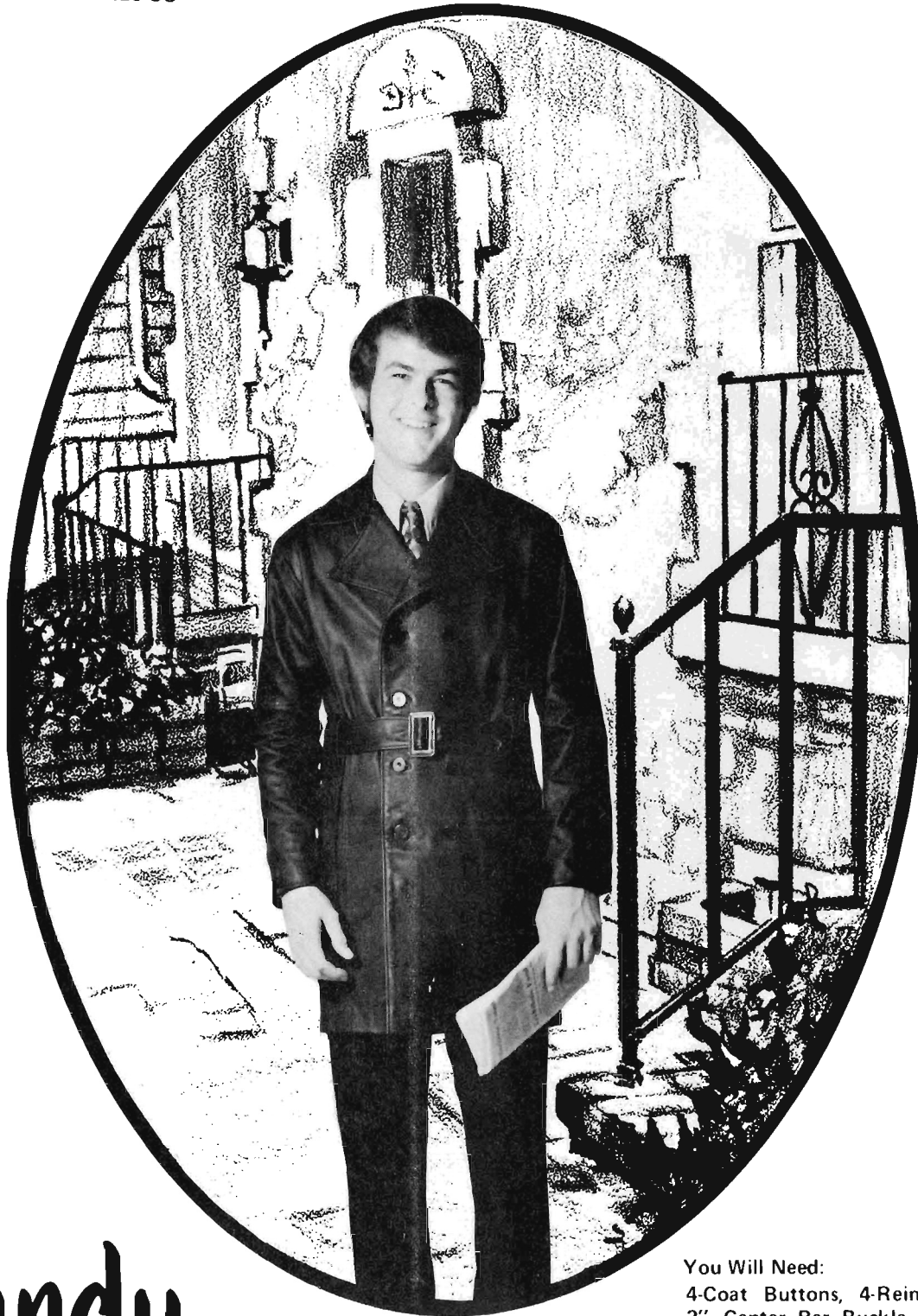

tandy
LEATHER COMPANY
A TANDY CORPORATION COMPANY

You Will Need:

4-Coat Buttons, 4-Reinforcing buttons,
2" Center Bar Buckle, Rubber Cement
and Cotton Wrapped Polyester Thread.

Suggested Materials:

Garment Cabretta, Reversible Garment
Sides, Mello-Tan Garment Sides or Softan
Cowhide.

General Instructions

Leather is nature's product and subject to its varying conditions. Climate, the food and care given the animal and season of slaughter are a few of many factors which occasionally effect skin flaws. These are natural and in no way mean the skin is inferior. Eliminate flaws, when cutting, by placing the pattern in such a way as to avoid them.

Cutting pattern pieces on crosswise grain (against the grain) tends to stretch leather. Therefore, all lengthwise grain line markings on the pattern are parallel to backbone.

PROCEDURE:

1. Because leather can not be folded, fashion duplicate paper patterns for all parts marked 'cut two'.
2. Lay out pattern pieces. Keep in mind the skin's greatest strength is down the center and parts which will incur the most wear should be cut from this backbone area.
3. Keep the pattern's lengthwise grainline parallel to backbone and try to have equal thicknesses of leather for related parts of your leather project.
4. Tape pattern to skin or attach with pins placed in the seam allowance. (Pattern may also be weighted down.)
5. Prior to cutting, you may want to trace around the pattern with chalk or pen. Then, with shears or razor knife, make the cut — employing long, even strokes.
6. Sewing leather usually entails some minor machine adjustments. First, change needles . . . we suggest size 11 for lightweight leathers and, for leathers of heavier weights, size 14. Adjust the stitch regulator to allow for seven to ten stitches per inch. (For sheer suedes, as many as twelve stitches per inch may be applied.) An extra-strength, more elastic thread (cotton-wrapped polyester thread) is needed for leatherwork.
7. Hold seams together with paper clips (7A), mending tape (7B) or pin in the seam allowance. Gently position leather under the pressure foot and tie the threads. Avoid backstitching — this weakens the leather.

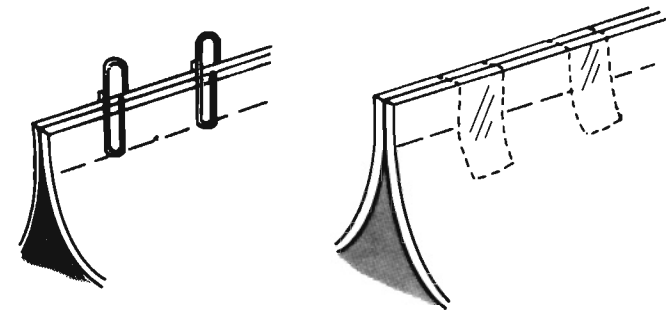

8. Reduce bulk by simply clipping curved seams (8A).



9. Now, apply rubber cement to all seam allowances (including curved seams) (9A).

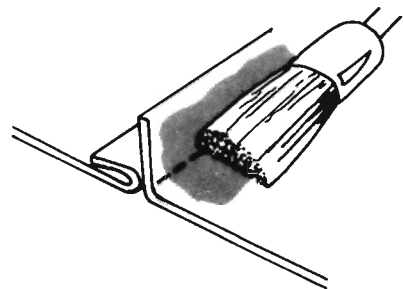

10. Pounding seams with a mallet, then lifting them lightly, flattens seams and lessens tension and pull.

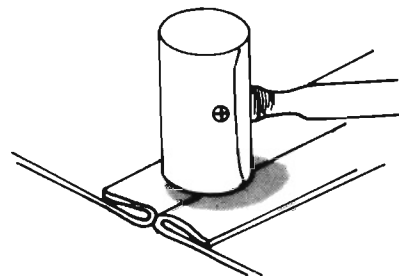

11. Place brown paper or press cloth between leather and iron and press with warm iron — do not steam.

Men's Top Coat Pattern

No. 2665

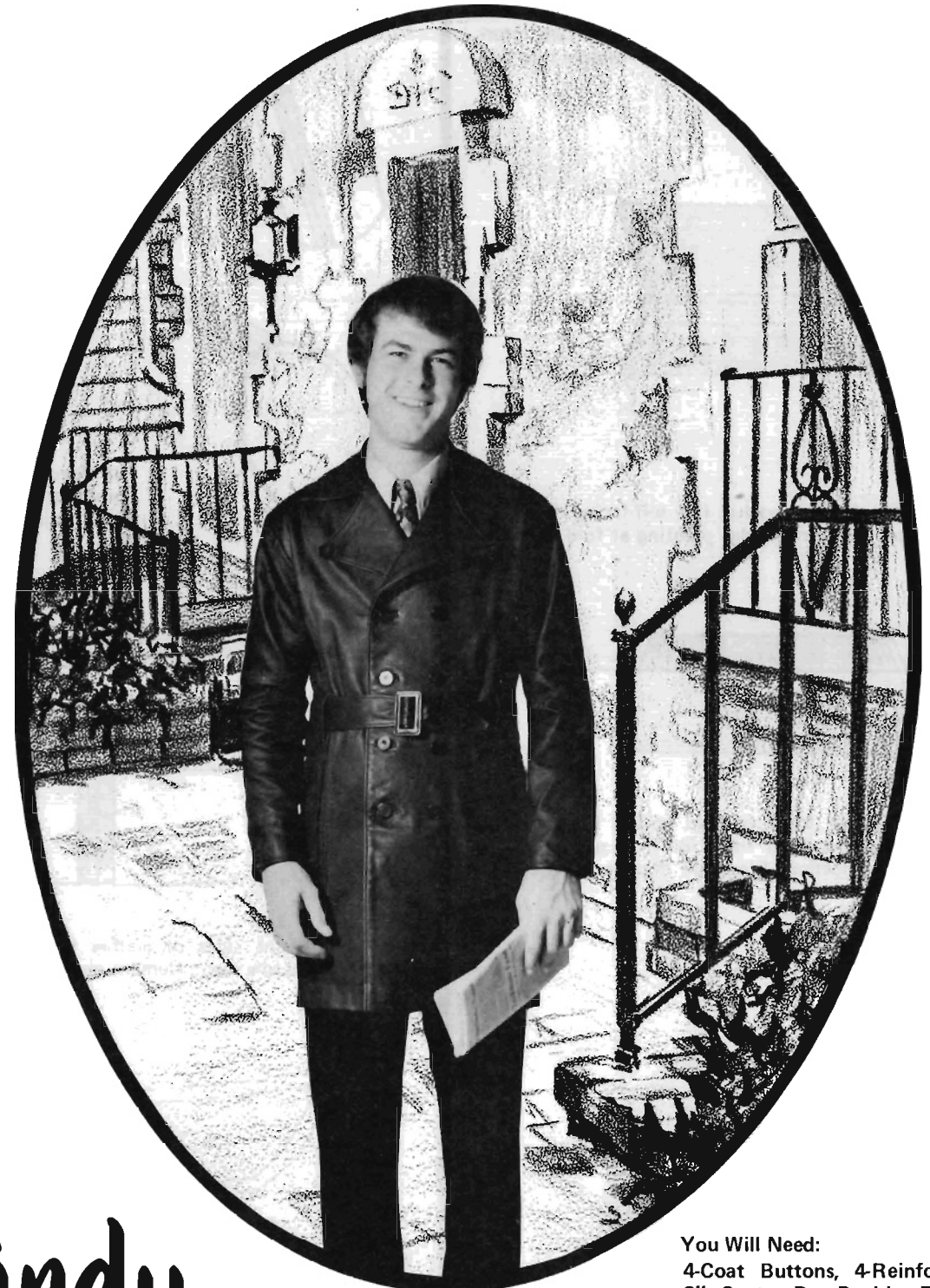

tandy
LEATHER COMPANY
A TANDY CORPORATION COMPANY

You Will Need:
4-Coat Buttons, 4-Reinforcing buttons,
2" Center Bar Buckle, Rubber Cement
and Cotton Wrapped Polyester Thread.

Suggested Materials:
Garment Cabretta, Reversible Garment
Sides, Mello-Tan Garment Sides or Softan
Cowhide.

Assembly Instructions

Grey screen indicates right side of leather.

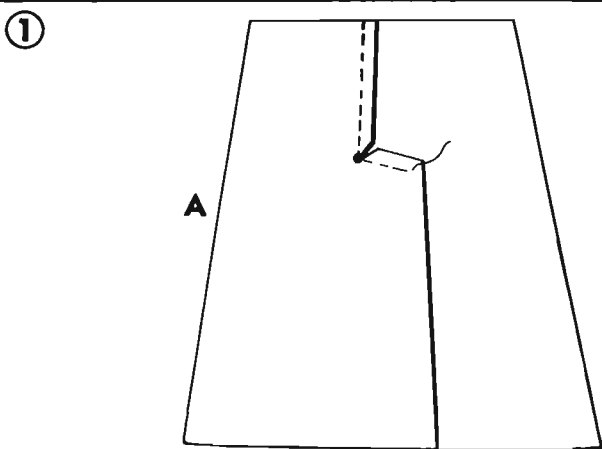

BACK AND KICK PLEAT. With right sides of leather together, baste bottom center-back seam edges. Stitch bottom center seams to circle pivot and continue along top of pleat extension, leaving sides of pleat extension free. Clip at circle.

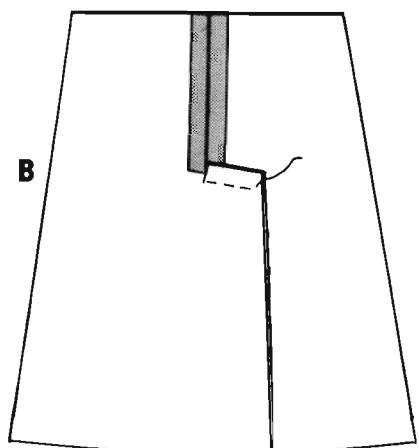

Cement seam allowances of center back down. Turn pleat extension edges toward left back. Baste upper edge of pleat extension with rubber cement to left back (B).

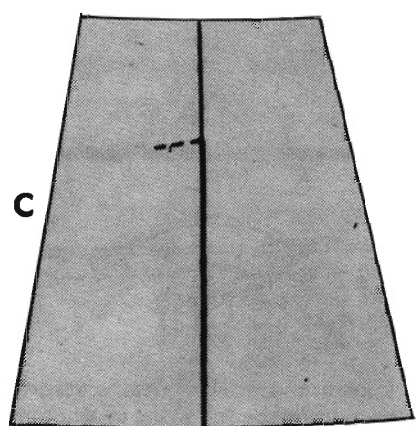

On right side, topstitch across upper edge of pleat extension along dotted line (C).

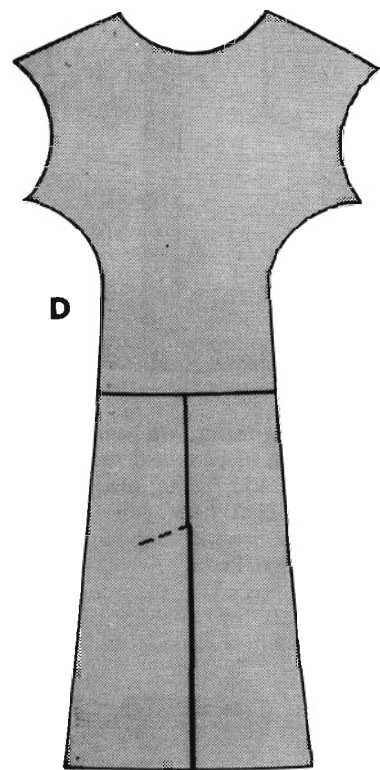

With right sides of leather together match notch on center back to seam at upper edge of bottom center back. Sew center back to bottom center back (D).

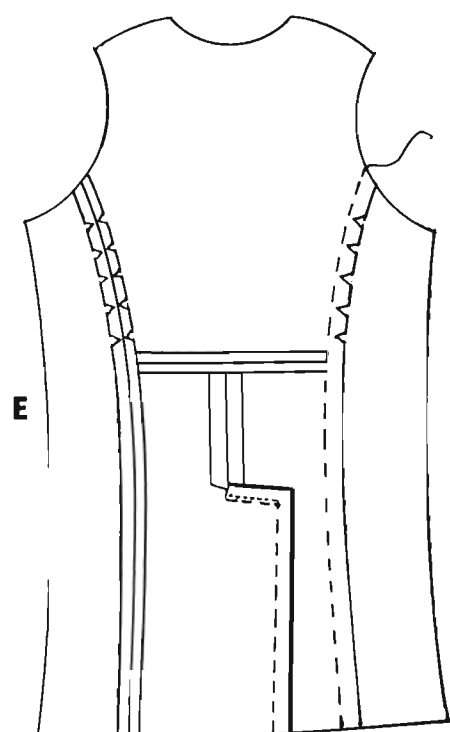

Stitch side backs to center back section, easing in side backs. Clip back seam edges as necessary. Cement seams open (E).

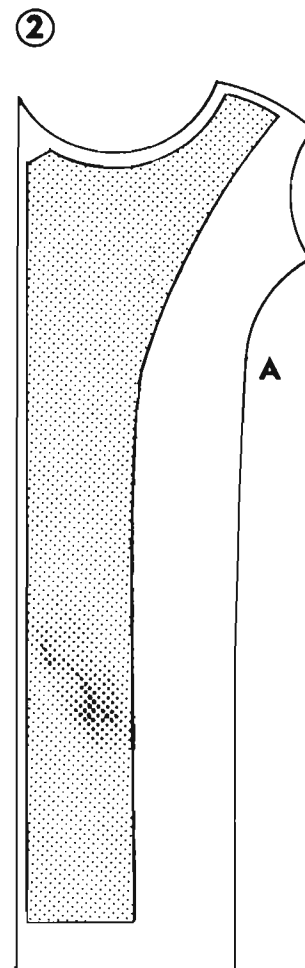

FRONT CONSTRUCTIONS. Baste front interfacing to wrong side of center front with rubber cement, bringing interfacing 1/4" away from edges (A).

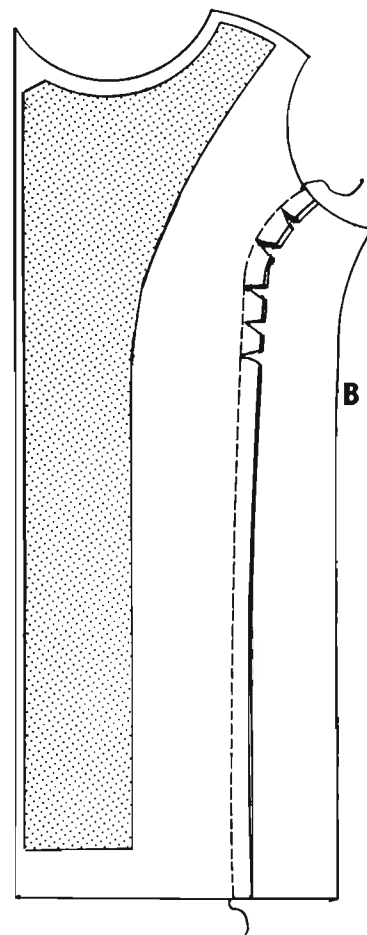

With right sides of leather together, stitch side fronts to center fronts, easing in side fronts. Clip edges as necessary (B). Cement seam allowances open.

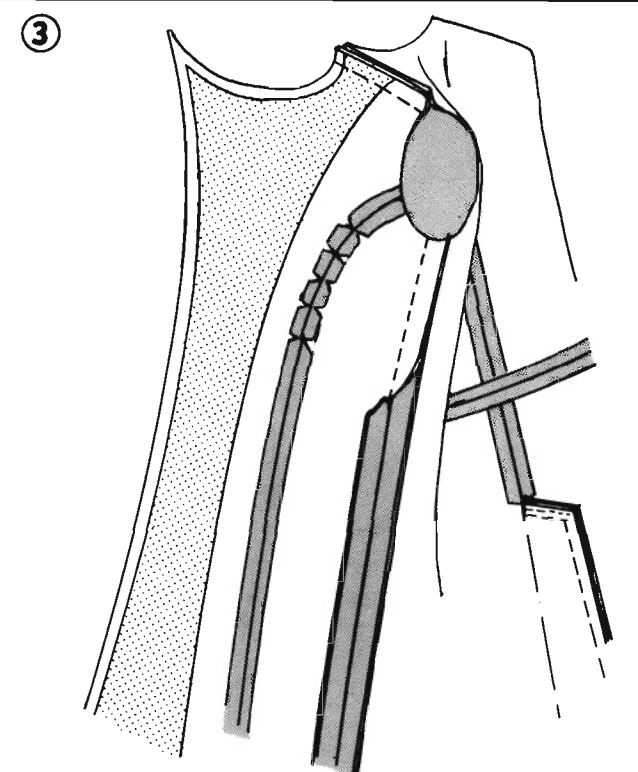

JOINING BACKS TO FRONTS. With right sides of leather together stitch shoulder seams. With right sides of leather together stitch side seams. Cement seam allowances open.

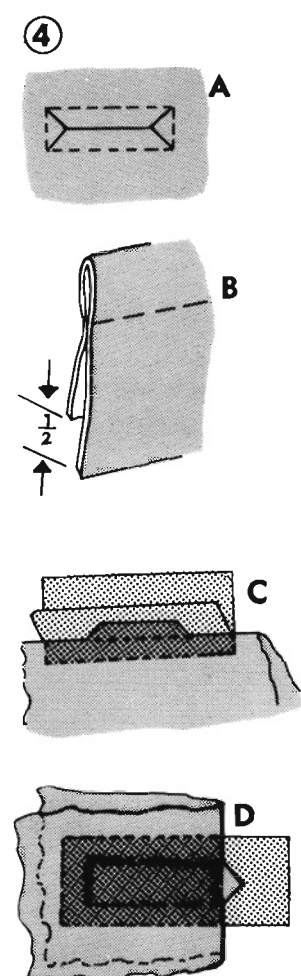

BUTTONHOLES. Make bound buttonholes on left front (see pattern for placement) following instructions below.

Mark placement of buttonhole with ball point pen on wrong side of leather. Length of buttonhole will be diameter plus one thickness of button. Mark off rectangle to indicate area of finished buttonhole (A). On stretchy leathers, stitch marked rectangle. Fold back small flaps and press (B). Prepare buttonhole strips by cutting two leather strips for each buttonhole about 2" wide. Fold lengthwise, right sides out, as shown, with fold about 1/2" from one edge (C). Place a prepared strip lengthwise in opening with widest part of strip toward wrong side of garment (D). Hold strip in position with tape and stitch along marked buttonhole line. (You will be stitching through three thicknesses of leather.) Repeat for other side (D). Pull loose ends of buttonhole through to wrong side of leather. Stitch to secure. Make cuts in facing same as original buttonhole. Turn under flaps, glue and pound with mallet.

General Instructions

Leather is nature's product and subject to its varying conditions. Climate, the food and care given the animal and season of slaughter are a few of many factors which occasionally effect skin flaws. These are natural and in no way mean the skin is inferior. Eliminate flaws, when cutting, by placing the pattern in such a way as to avoid them.

Cutting pattern pieces on crosswise grain (against the grain) tends to stretch leather. Therefore, all lengthwise grain line markings on the pattern are parallel to backbone.

PROCEDURE:

1. Because leather can not be folded, fashion duplicate paper patterns for all parts marked 'cut two'.
2. Lay out pattern pieces. Keep in mind the skin's greatest strength is down the center and parts which will incur the most wear should be cut from this backbone area.
3. Keep the pattern's lengthwise grainline parallel to backbone and try to have equal thicknesses of leather for related parts of your leather project.
4. Tape pattern to skin or attach with pins placed in the seam allowance. (Pattern may also be weighted down.)
5. Prior to cutting, you may want to trace around the pattern with chalk or pen. Then, with shears or razor knife, make the cut — employing long, even strokes.
6. Sewing leather usually entails some minor machine adjustments. First, change needles . . . we suggest size 11 for

8. Reduce bulk by simply clipping curved seams (8A).



9. Now, apply rubber cement to all seam allowances (including curved seams) (9A).

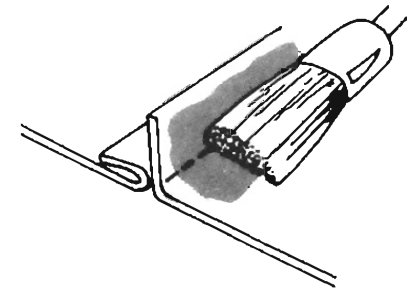

Men's Top Coat Pattern

No. 2665

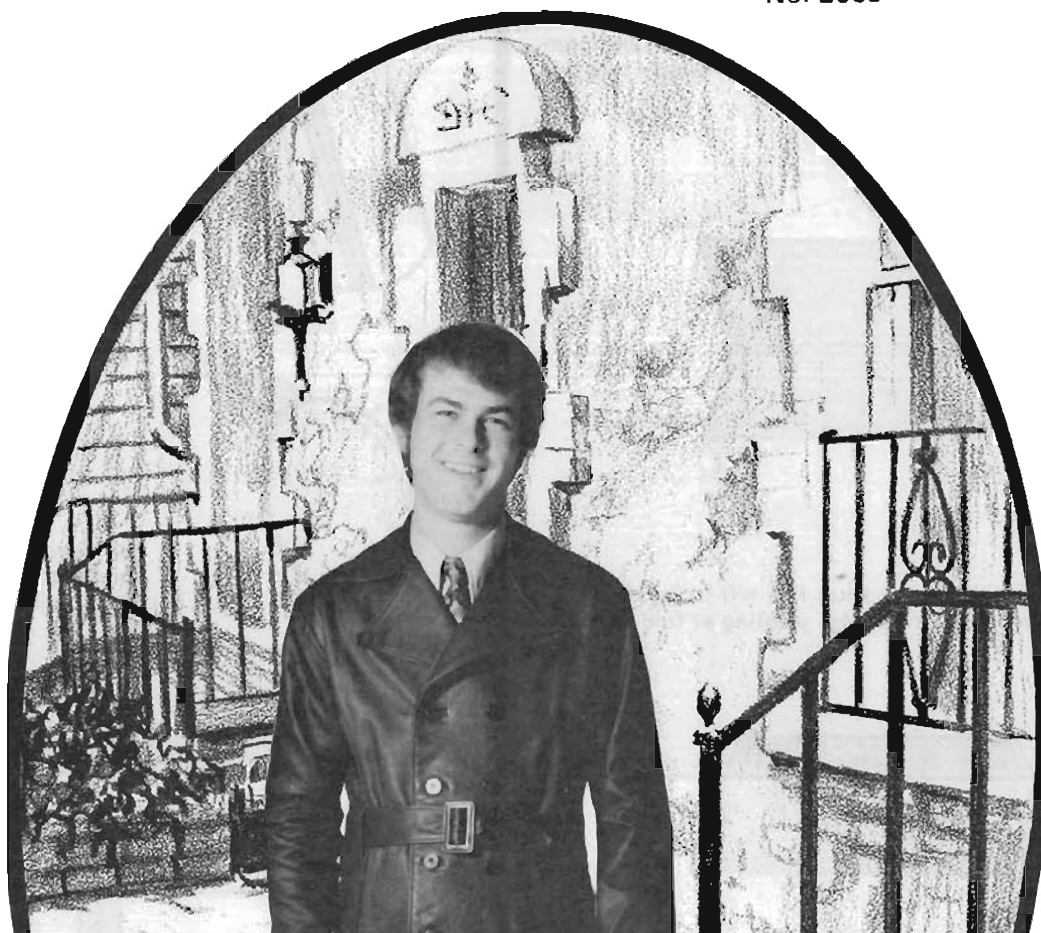

lightweight leathers and, for leathers of heavier weights, size 14. Adjust the stitch regulator to allow for seven to ten stitches per inch. (For sheer suedes, as many as twelve stitches per inch may be applied.) An extra-strength, more elastic thread (cotton-wrapped polyester thread) is needed for leatherwork.

7. Hold seams together with paper clips (7A), mending tape (7B) or pin in the seam allowance. Gently position leather under the pressure foot and tie the threads. Avoid backstitching – this weakens the leather.

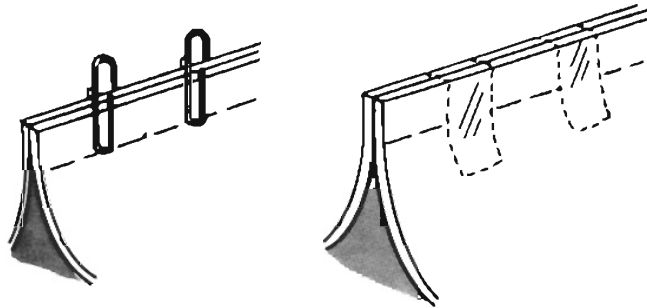

10. Pounding seams with a mallet, then lifting them lightly, flattens seams and lessens tension and pull.

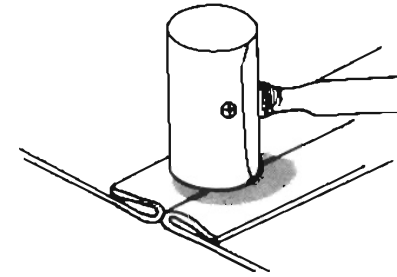

11. Place brown paper or press cloth between leather and iron and press with warm iron – do not steam.

Assembly Instructions

Grey screen indicates right side of leather.

①

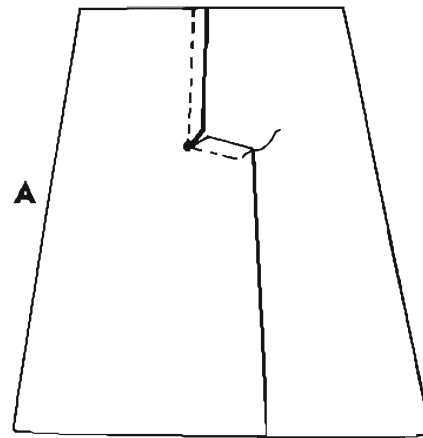

BACK AND KICK PLEAT. With right sides of leather together

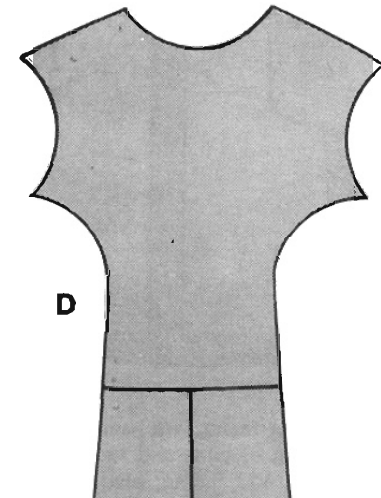



You Will Need:

4-Coat Buttons, 4-Reinforcing buttons,
2" Center Bar Buckle, Rubber Cement
and Cotton Wrapped Polyester Thread.

Suggested Materials:

Garment Cabretta, Reversible Garment
Sides, Mello-Tan Garment Sides or Softan
Cowhide.

②

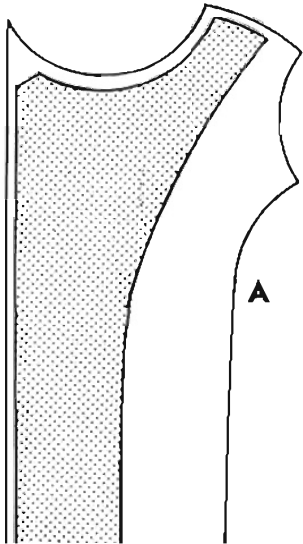

FRONT CONSTRUCTIONS.
Back, front interfacing to

③

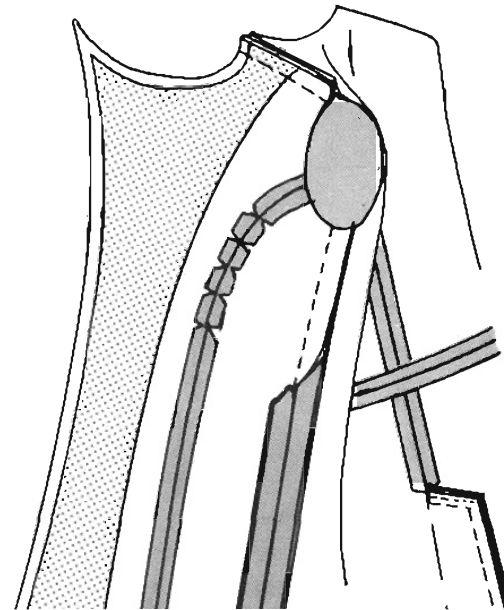

...together, baste bottom center-back seam edges. Stitch bottom center seams to circle pivot and continue along top of pleat extension, leaving sides of pleat extension free. Clip at circle.

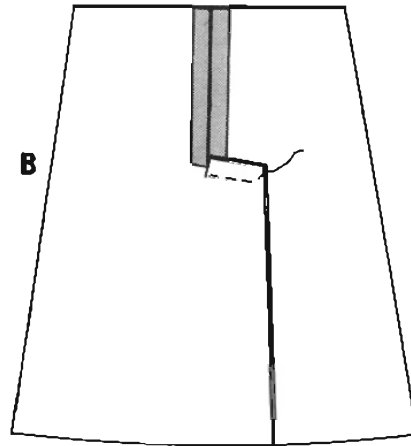

Cement seam allowances of center back down. Turn pleat extension edges toward left back. Baste upper edge of pleat extension with rubber cement to left back (B).

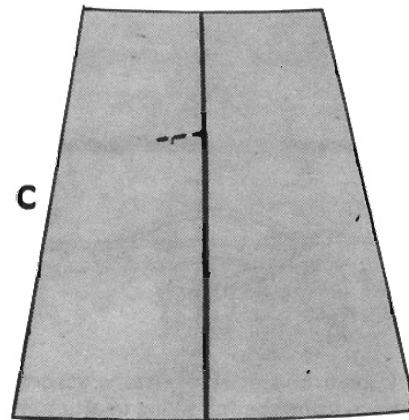

On right side, topstitch across upper edge of pleat extension along dotted line (C).

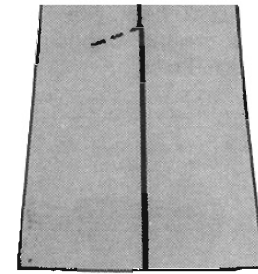

With right sides of leather together match notch on center back to seam at upper edge of bottom center back. Sew center back to bottom center back (D).

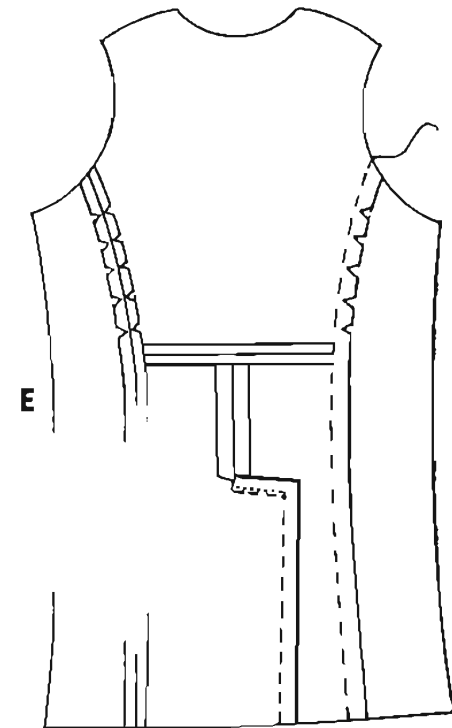

Stitch side backs to center back section, easing in side backs. Clip back seam edges as necessary. Cement seams open (E).

Base front interfacing to wrong side of center front with rubber cement, bringing interfacing 1/4" away from edges (A).

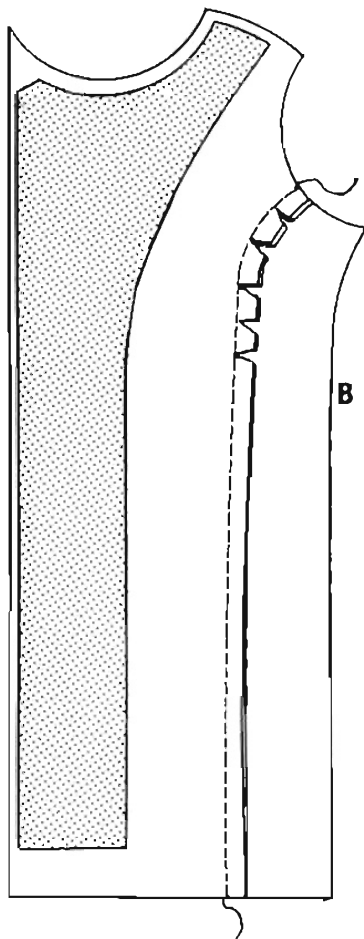
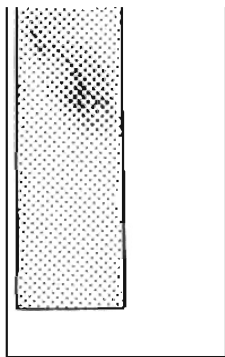

With right sides of leather together, stitch side fronts to center fronts, easing in side fronts. Clip edges as necessary (B). Cement seam allowances open.

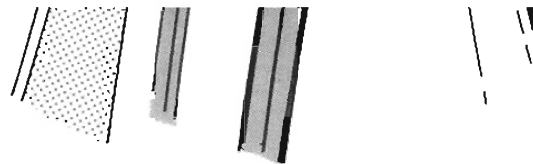

JOINING BACKS TO FRONTS. With right sides of leather together stitch shoulder seams. With right sides of leather together stitch side seams. Cement seam allowances open.

④

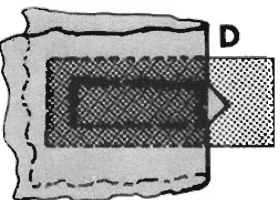
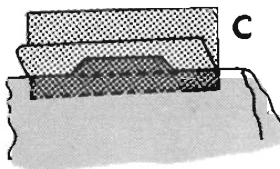
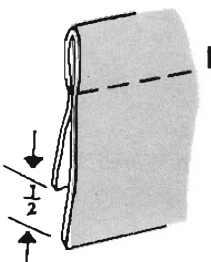
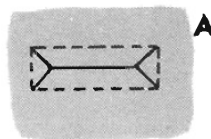

BUTTONHOLES. Make bound buttonholes on left front (see pattern for placement) following instructions below.

Mark placement of buttonhole with ball point pen on wrong side of leather. Length of buttonhole will be diameter plus one thickness of button. Mark off rectangle to indicate area of finished buttonhole (A). On stretchy leathers, stitch marked rectangle. Cut buttonhole as shown. Fold back small flaps and press (B). Prepare buttonhole strips by cutting two leather strips for each buttonhole about 2" wide. Fold lengthwise, right sides out, as shown, with fold about 1/2" from one edge (C). Place a prepared strip lengthwise in opening with widest part of strip toward wrong side of garment (D). Hold strip in position with tape and stitch along marked buttonhole line. (You will be stitching through three thicknesses of leather.) Repeat for other side (D). Pull loose ends of buttonhole through to wrong side of leather. Stitch to secure. Make cuts in facing same as original buttonhole. Turn under flaps, glue and pound with mallet.

5

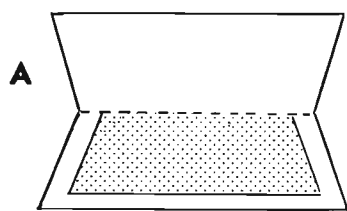

POCKET FLAP. Baste with rubber cement pocket flap interfacing to wrong side of pocket flap, aligning with middle fold line (A).

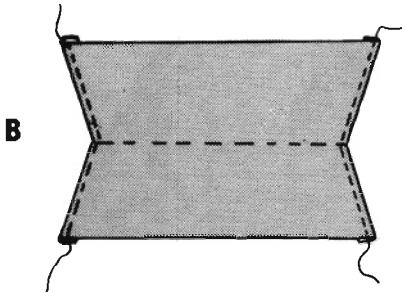

Apply cement to outer edges of pocket flap self-facing. Fold on seam line and topstitch 1/8" from edge pivoting at fold line (B).

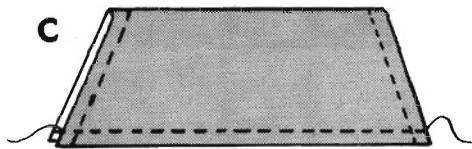

With wrong sides of leather together, fold pocket flap on fold line. Stitch together loose ends of flap 1/8" from edge (C). Do not stitch ends of flap together. Flaps are designed to be belt keepers.

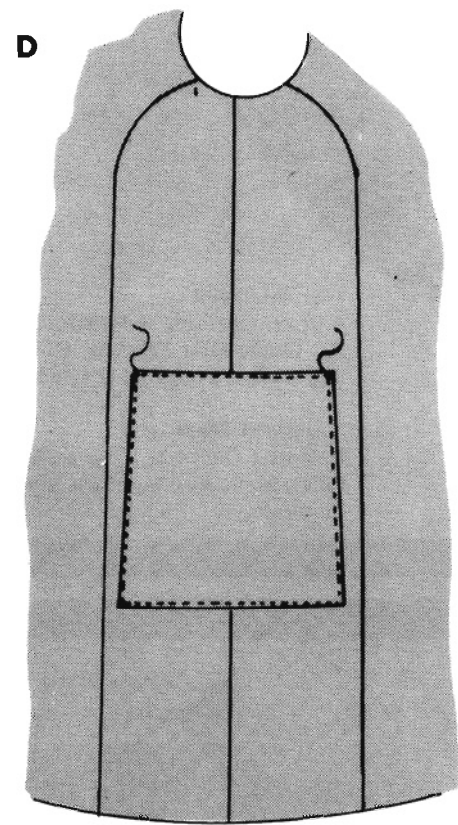

Apply rubber cement to inside area of top of pocket. Fold on fold line and stitch 1/8" away from edge. Place pocket on pocket placement lines and topstitch down 1/8" from edge (D).

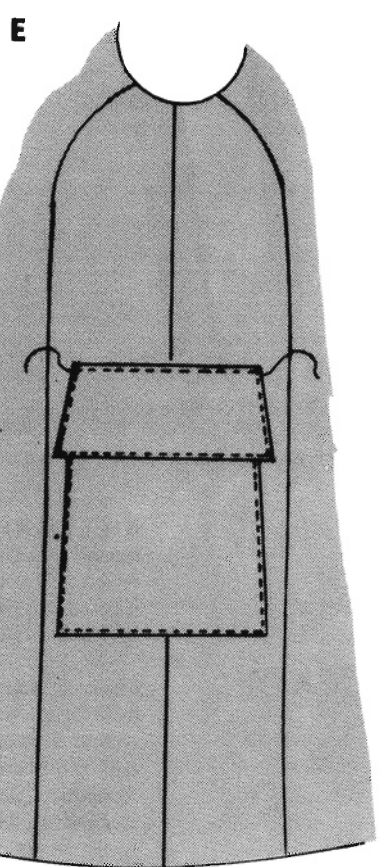

Lay pocket flap on pocket flap placement line and topstitch down along folded edge 1/8" from edge (E).

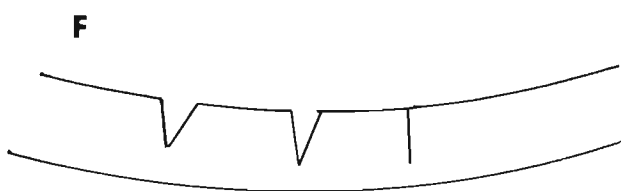

Turn coat hem up to desired length. Use rubber cement to hem coat. Apply cement to inside of hem area and press down. Triangular notches may need to be cut in hem to reduce bulk (F). Tap with mallet so hem will lie flat.

6

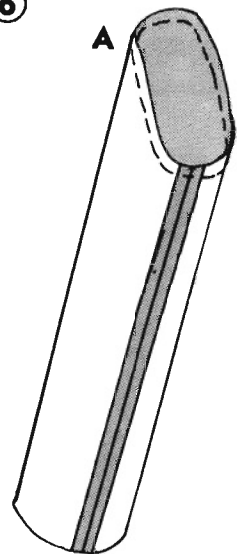

SLEEVES. Control ease in sleeve cap with a single row of stitching on seam line. Fold sleeve and stitch sleeve seam with right sides of leather together (A).

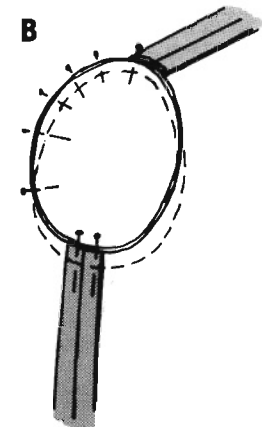

Pin sleeve into armhole, matching underarm seams. Ease so sleeve fits. Baste, adjusting ease. Stitch. Trim. (B).

7

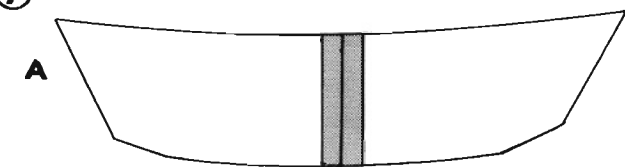

COLLAR. Right sides of leather together, stitch undercollars together at middle seam. Cement seam allowances down (A).

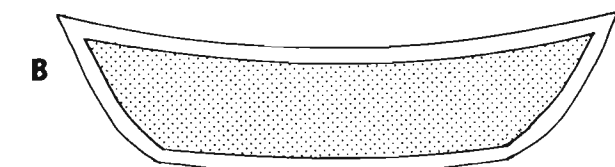

With rubber cement baste interfacing to wrong side of top collar (B).

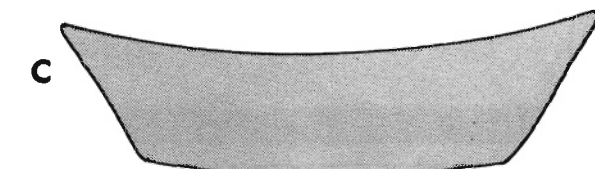

Right sides together, stitch collar together. Clip corners, trim, turn and press (C).

8

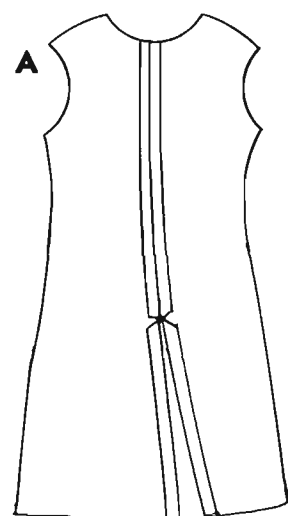

LINING. Right sides together, sew back linings together starting at neck edge and continuing to notch. Clip at dot and press seam open (A).

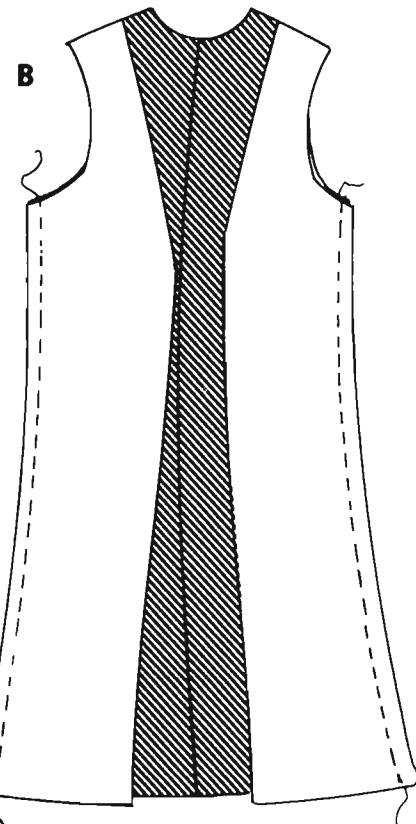

With right sides together, join front lining to back lining at side seam. Press seams open (B).

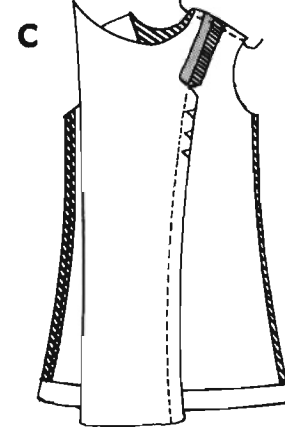

Hem lining before attaching front facing. With right side of front facing to right side of front lining, stitch together. Clip where necessary. Press seams open. Stitch together at shoulder seams (C). Repeat for other side.

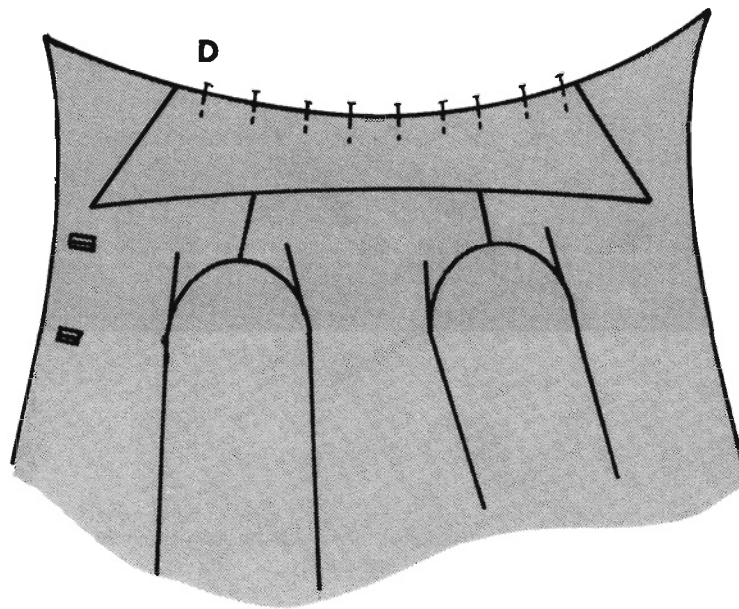

INSTALLING LINING. Pin collar between notches on center fronts with undercollar on bottom (D).

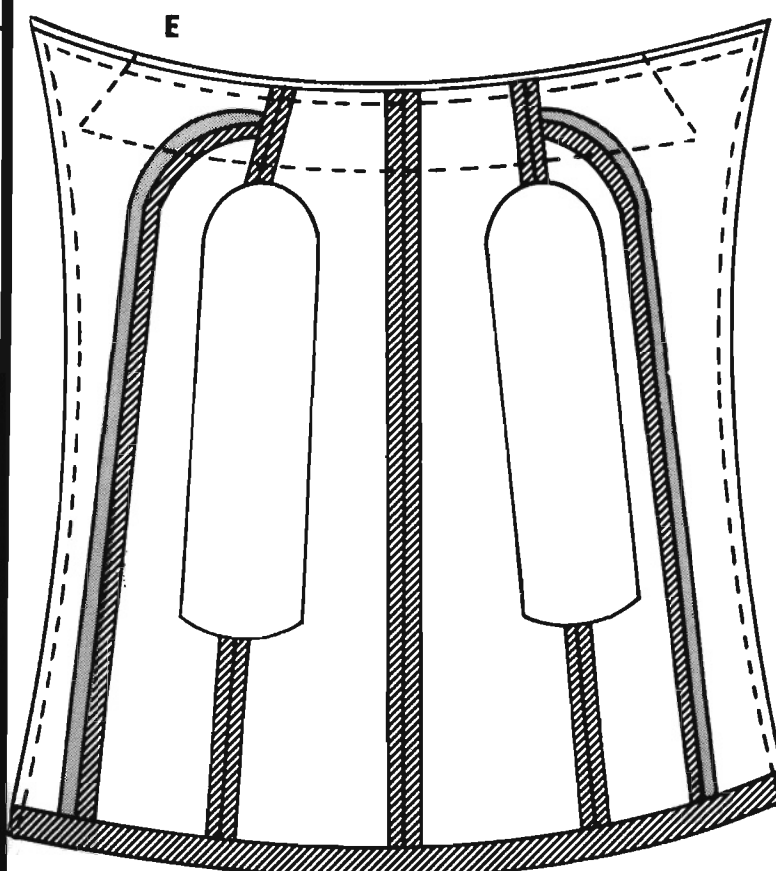

Take right side of front facing and linings and baste to coat. Begin stitching at lower hem of coat and facing and continue stitching up to corner of coat and facing, pivoting at corner, going along neck edge, catching coat neck edge, collar, facing and lining. Continue completely around opposite edge of coat (E). Clip curves, corners and turn. Press.

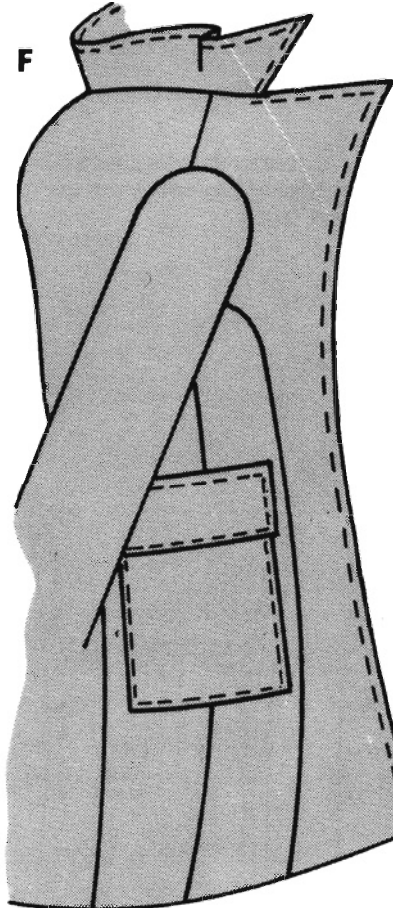

Beginning at lower edge of center front sections, topstitch 1/8" away from front and collar edges as illustrated (F). Complete underside of bound buttonhole.

9

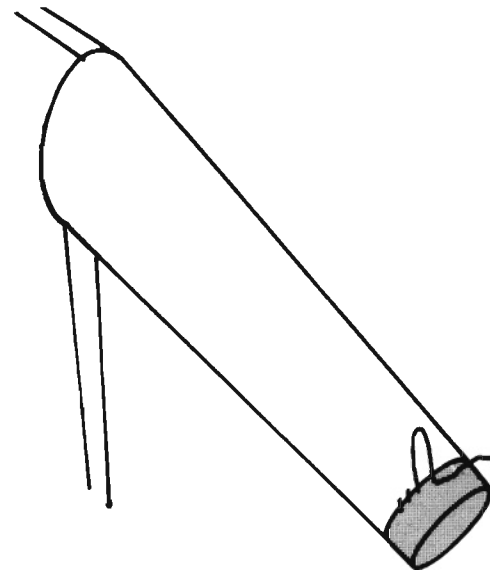

Pull coat sleeve out inside sleeve lining. To form lower sleeve facing, turn end of coat sleeve under and cement down. Cement should be applied to inside area of lower sleeve (G).

10

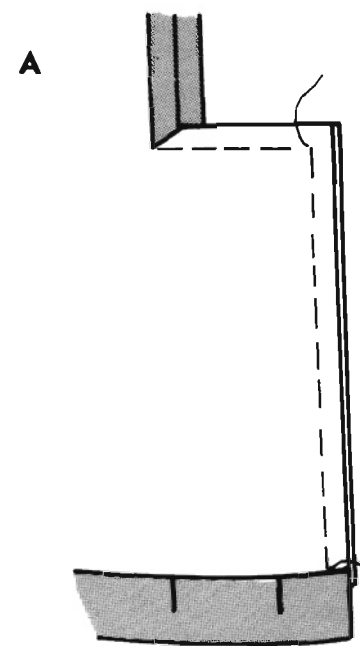

FINISHING KICK PLEAT. With right sides together, catch right top seam allowance of kick pleat with right edge of lining. Sew together (A).

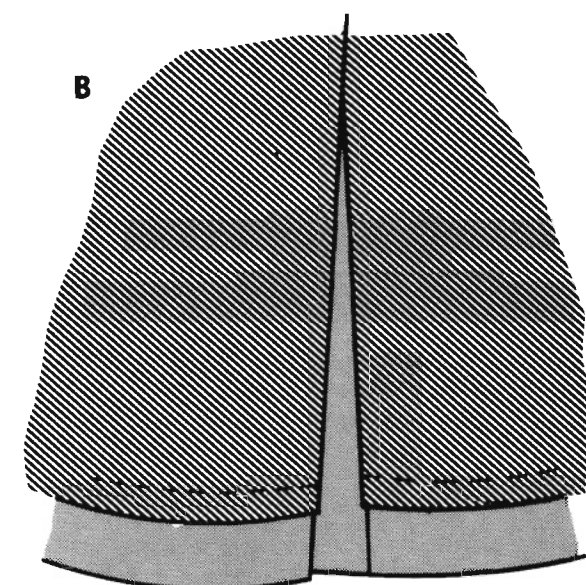

Repeat for left side (B).

11

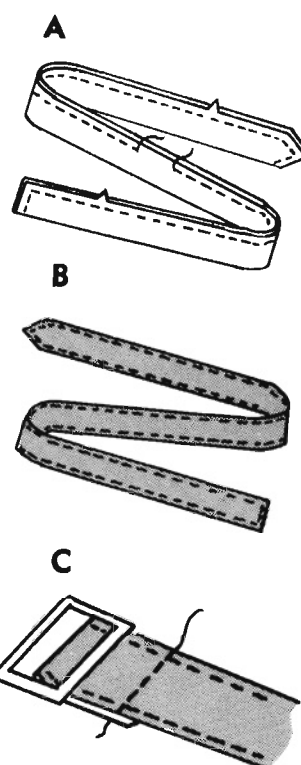

BELT. With right sides of leather together, sew belt pieces together at 1/2" seam allowance edges. Fold belt on fold line, right sides of leather together (A). Stitch seam edges and taking up 1/4" seam, leaving an opening for turning. Turn right side out and cement opening edges together. Trim seam allowances. Topstitch 1/8" from outer edges of belt (B). Attach buckle by slipping buckle on buckle end of belt and folding leather around center bar of buckle. Stitch both thicknesses together (C).

11

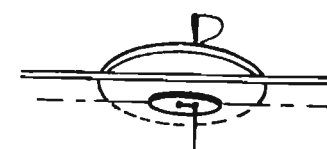

BUTTONS. Locate and attach buttons according to placement shown on pattern using the following instructions:

To sew on a button with a stay button: for jacket and coat buttons receiving hard wear sew a small button directly under the top button on the facing side as shown. Both buttons are sewn on in one operation.

5

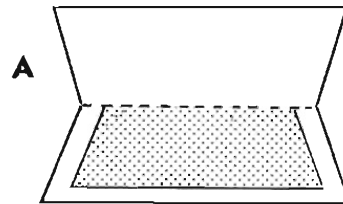

POCKET FLAP. Baste with rubber cement pocket flap interfacing to wrong side of pocket flap, aligning with middle fold line (A).

B

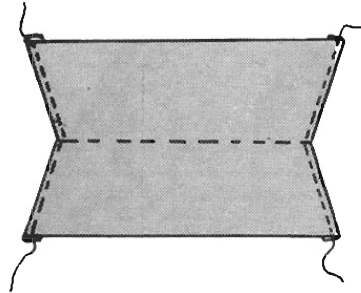

Apply cement to outer edges of pocket flap self-facing. Fold on seam line and topstitch 1/8" from edge pivoting at fold line (B).

C

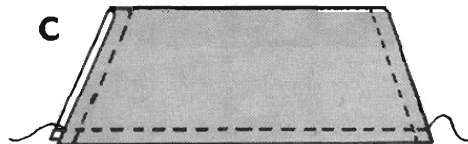

6

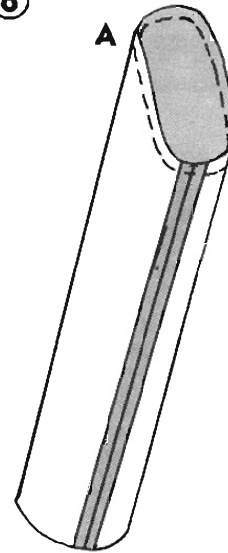

SLEEVES. Control ease in sleeve cap with a single row of stitching on seam line. Fold sleeve and stitch sleeve seam with right sides of leather together (A).

B

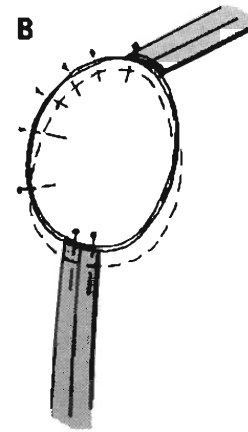

Pin sleeve into armhole, matching underarm seams. Ease so sleeve fits. Baste, adjusting ease. Stitch. Trim. (B).

7



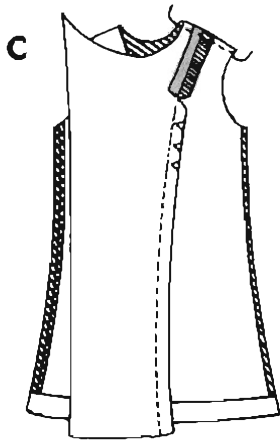

Hem lining before attaching front facing. With right side of front facing to right side of front lining, stitch together. Clip where necessary. Press seams open. Stitch together at shoulder seams (C). Repeat for other side.

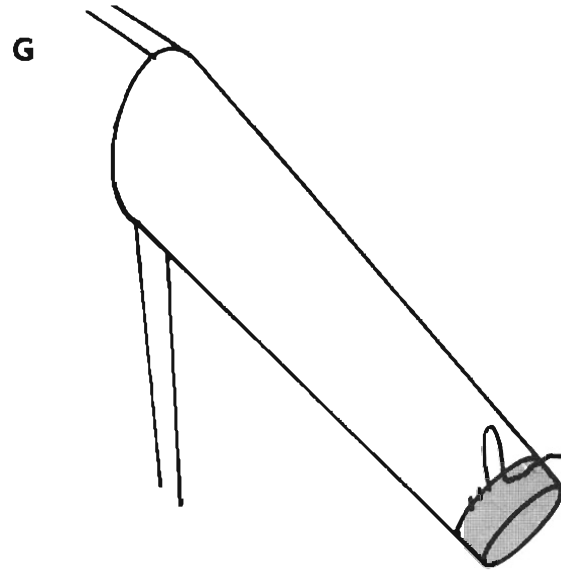

Pull coat sleeve out inside sleeve lining. To form lower sleeve facing, turn end of coat sleeve under and cement down. Cement should be applied to inside area of lower sleeve (G).

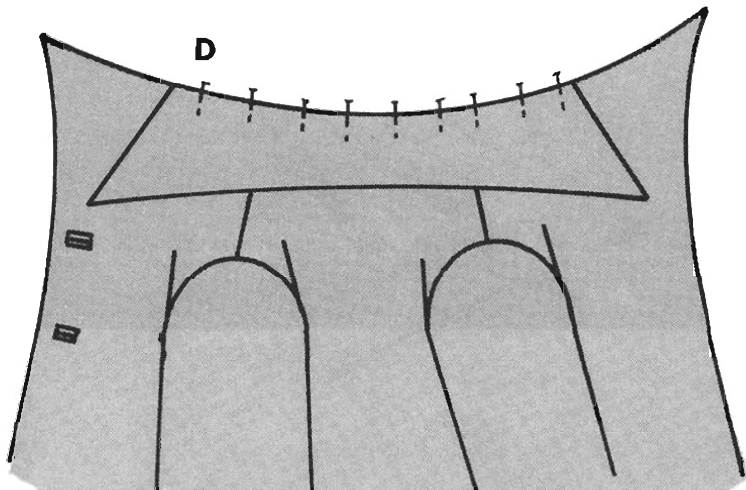

9

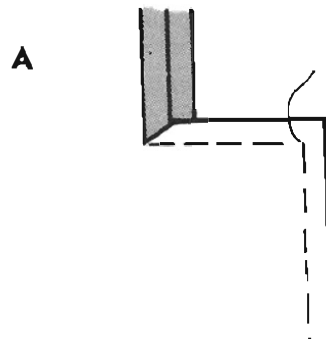

With wrong sides of leather together, fold pocket flap on fold line. Stitch together loose ends of flap 1/8" from edge (C). Do not stitch ends of flap together. Flaps are designed to be belt keepers.

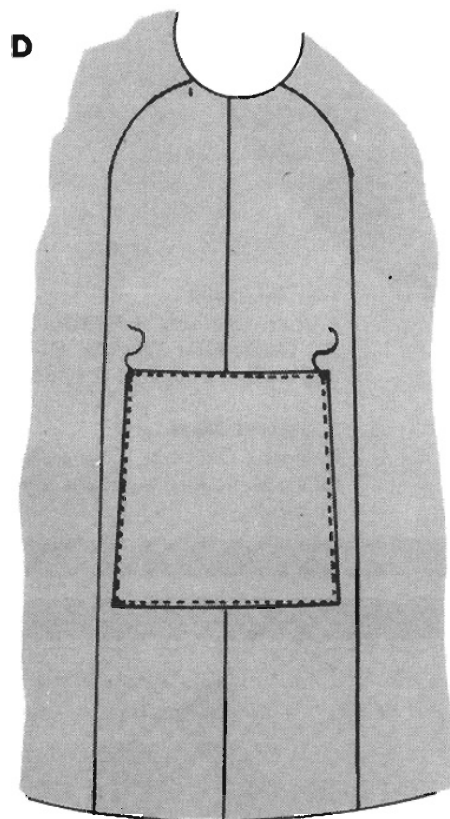

Apply rubber cement to inside area of top of pocket. Fold on fold line and stitch 1/8" away from edge. Place pocket on pocket placement lines and topstitch down 1/8" from edge (D).

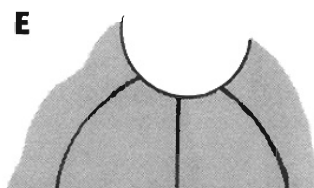

COLLAR. Right sides of leather together, stitch undercollars together at middle seam. Cement seam allowances down (A).

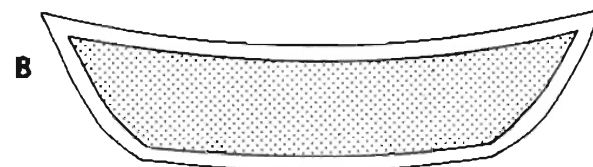

With rubber cement baste interfacing to wrong side of top collar (B).

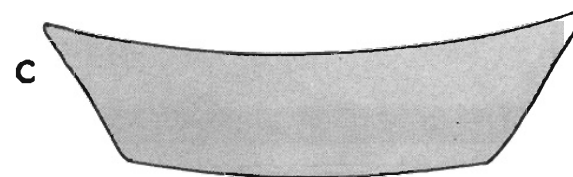

Right sides together, stitch collar together. Clip corners, trim, turn and press (C).

⑧

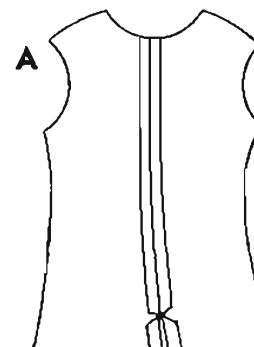

LINING. Right sides together, sew back linings together starting at neck edge and continuing to notch. Clip at dot and press seam open (A).

INSTALLING LINING. Pin collar between notches on center fronts with undercollar on bottom (D).

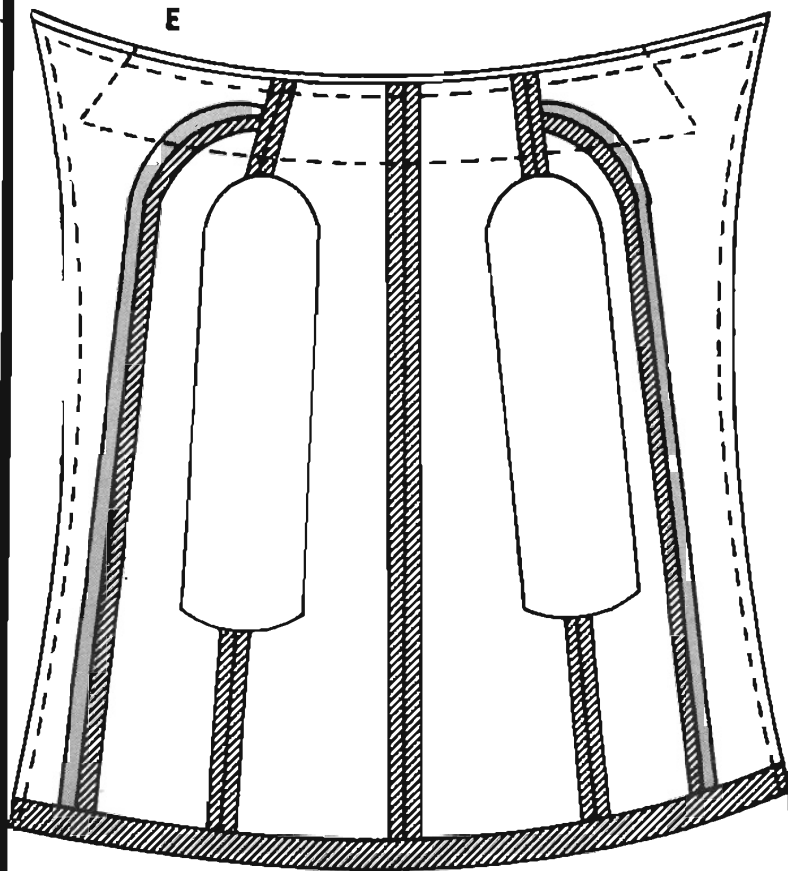

Take right side of front facing and linings and baste to coat. Begin stitching at lower hem of coat and facing and continue stitching up to corner of coat and facing, pivoting at corner, going along

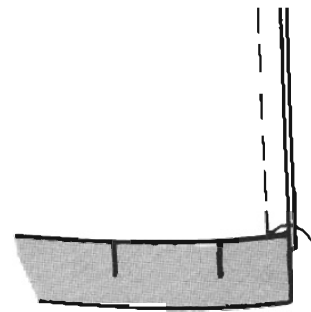

FINISHING KICK PLEAT. With right sides together, catch right top seam allowance of kick pleat with right edge of lining. Sew together (A).

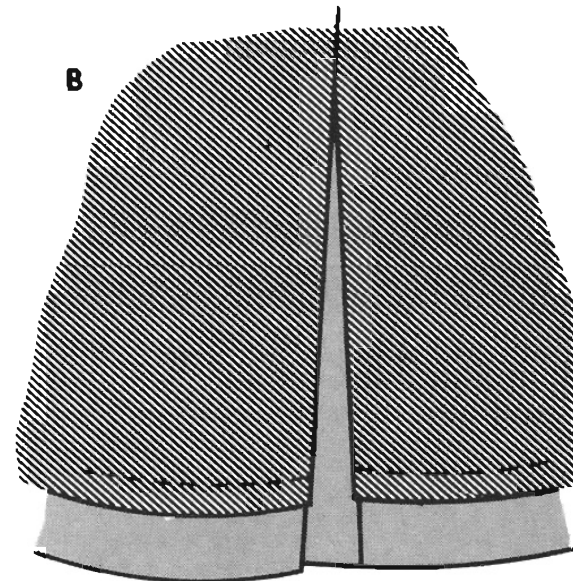

Repeat for left side (B).

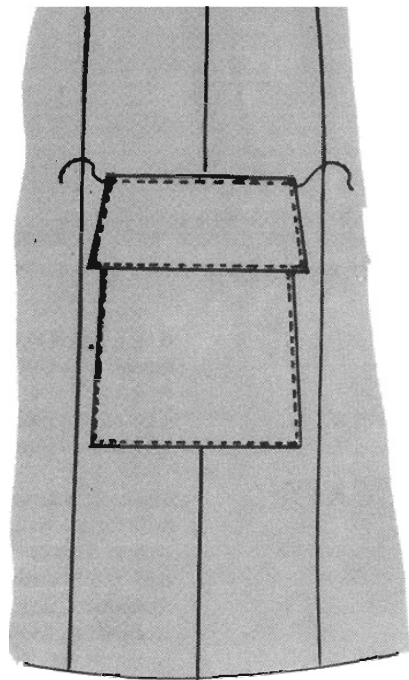

Lay pocket flap on pocket flap placement line and topstitch down along folded edge 1/8" from edge (E).



Turn coat hem up to desired length. Use rubber cement to hem coat. Apply cement to inside of hem area and press down. Triangular notches may need to be cut in hem to reduce bulk (F). Tap with mallet so hem will lie flat.

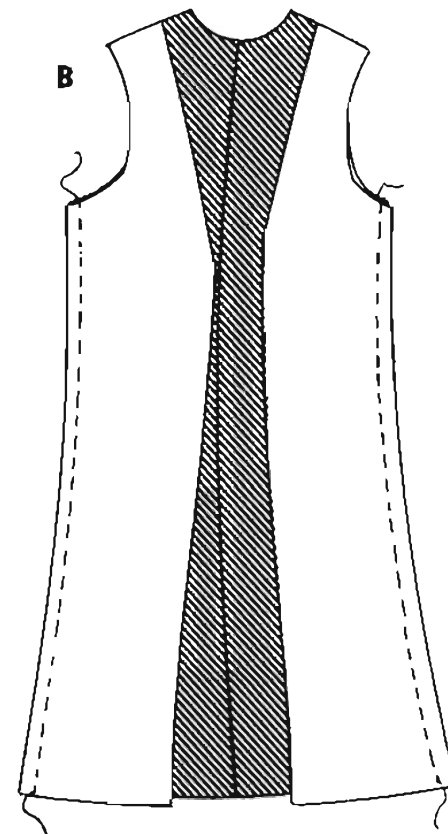
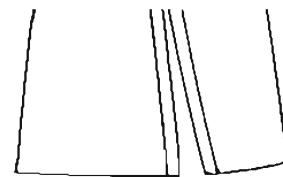

With right sides together, join front lining to back lining at side seam. Press seams open (B).

neck edge, catching coat neck edge, collar, facing and lining. Continue completely around opposite edge of coat (E). Clip curves, corners and turn. Press.

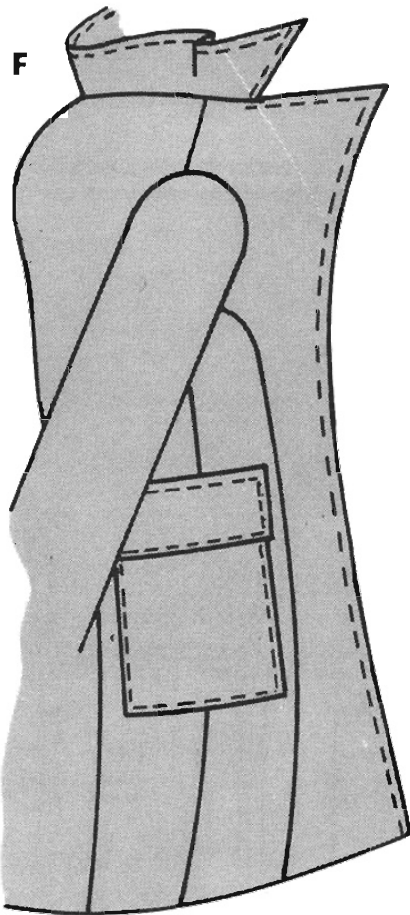

Beginning at lower edge of center front sections, topstitch 1/8" away from front and collar edges as illustrated (F). Complete underside of bound buttonhole.

A

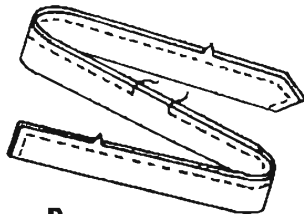

B

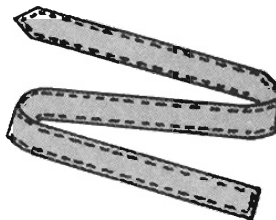

C

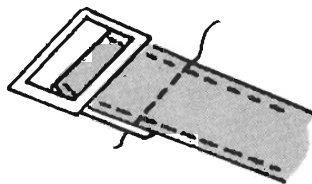

BELT. With right sides of leather together, sew belt pieces together at 1/2" seam allowance edges. Fold belt on fold line, right sides of leather together (A). Stitch seam edges and taking up 1/4" seam, leaving an opening for turning. Trim seam allowances. Turn right side out and cement opening edges together. Topstitch 1/8" from outer edges of belt (B). Attach buckle by slipping buckle on buckle end of belt and folding leather around center bar of buckle. Stitch both thicknesses together (C).

11

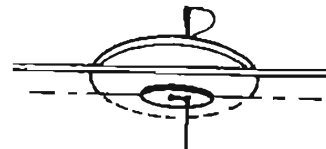

BUTTONS. Locate and attach buttons according to placement shown on pattern using the following instructions:

To sew on a button with a stay button: for jacket and coat buttons receiving hard wear sew a small button directly under the top button on the facing side as shown. Both buttons are sewn on in one operation.

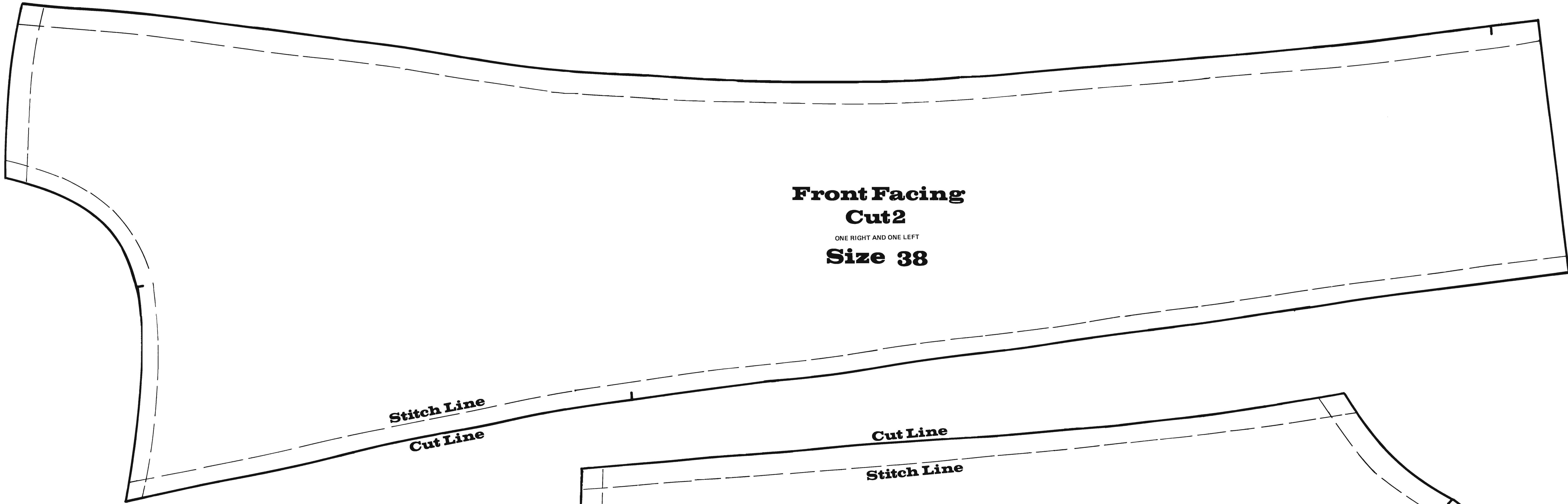

Front Facing
Cut 2
ONE RIGHT AND ONE LEFT
Size 38

Stitch Line
Cut Line

Cut Line
Stitch Line

Men's Top Coat
Pattern Pieces
Size 38

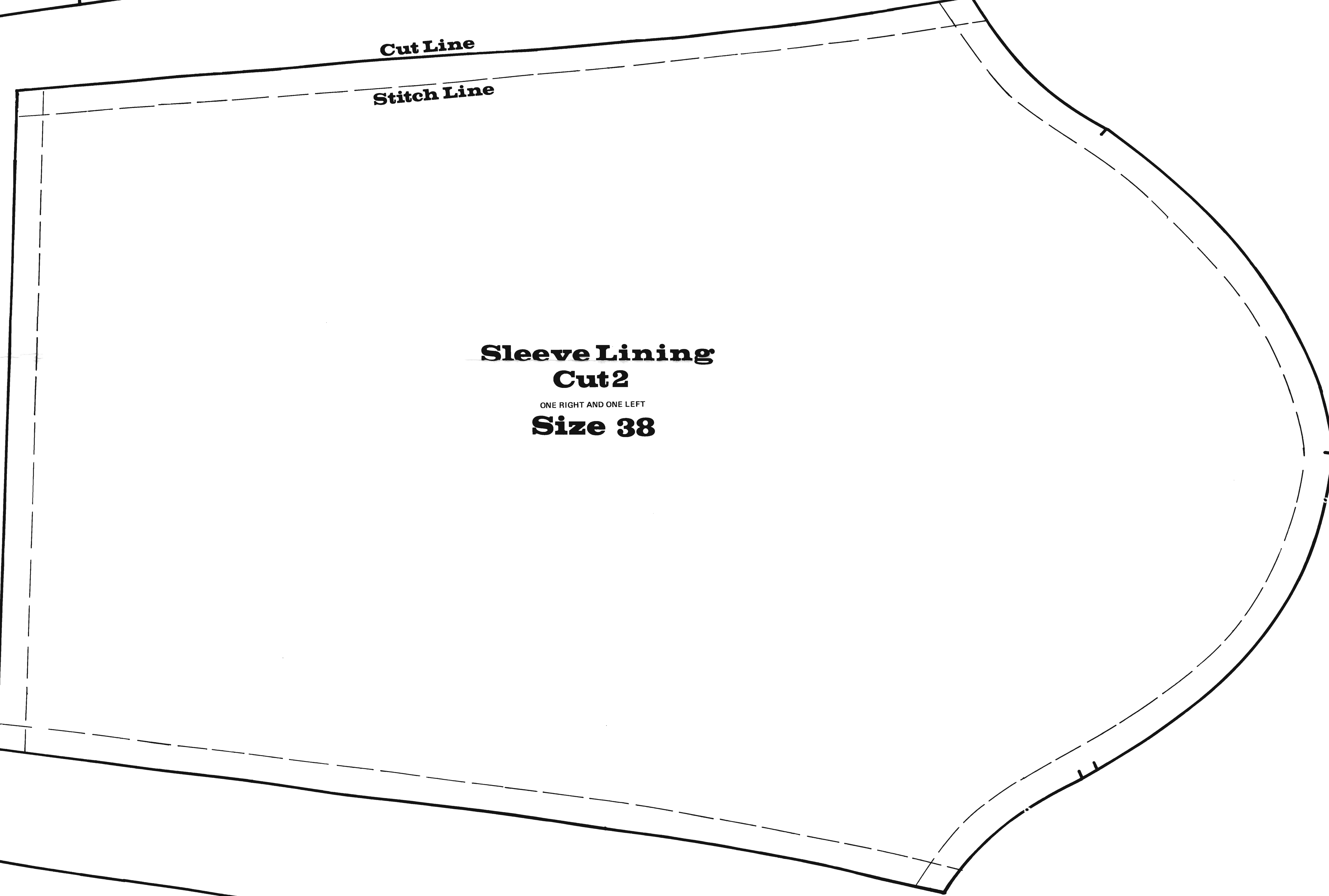

Sleeve Lining
Cut 2
ONE RIGHT AND ONE LEFT
Size 38

Cut Line

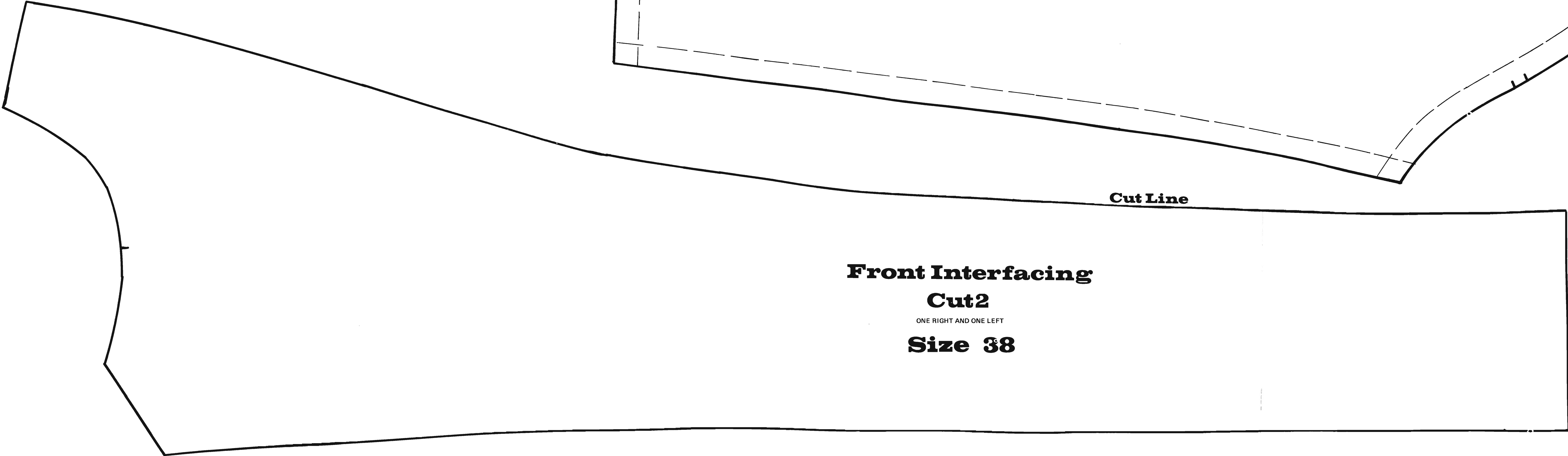

Front Interfacing
Cut 2
ONE RIGHT AND ONE LEFT
Size 38

Cut Line
Stitch Line



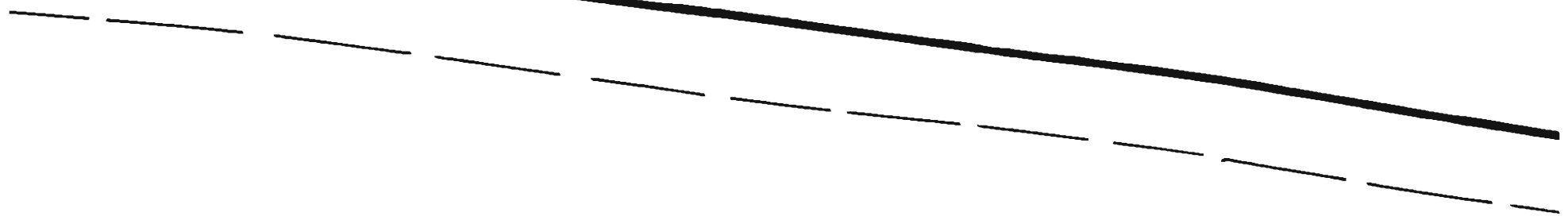
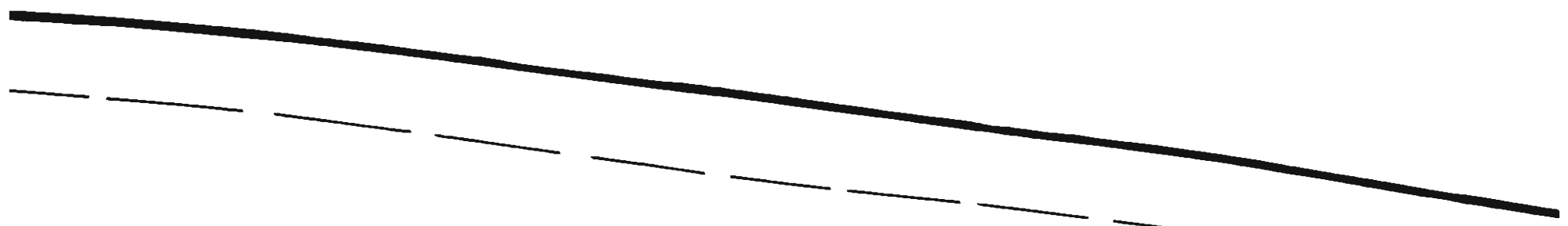

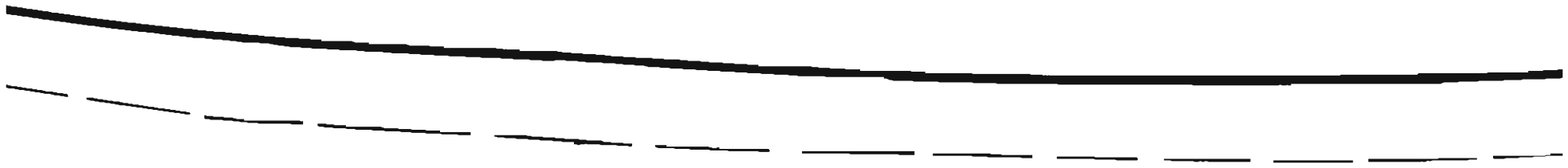

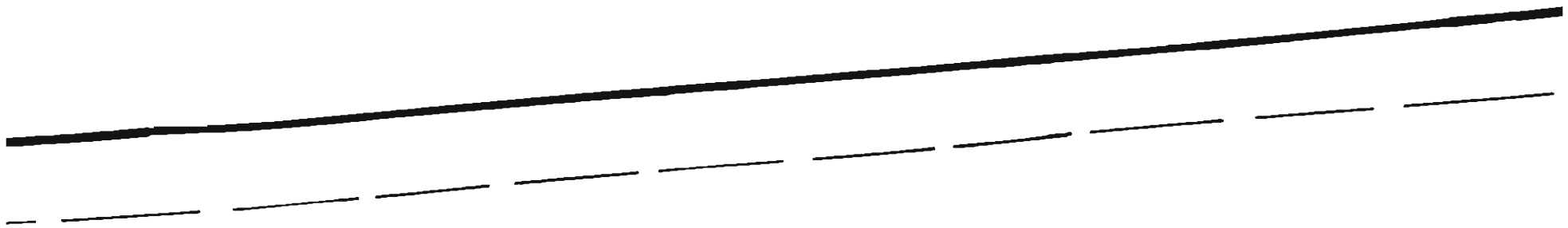

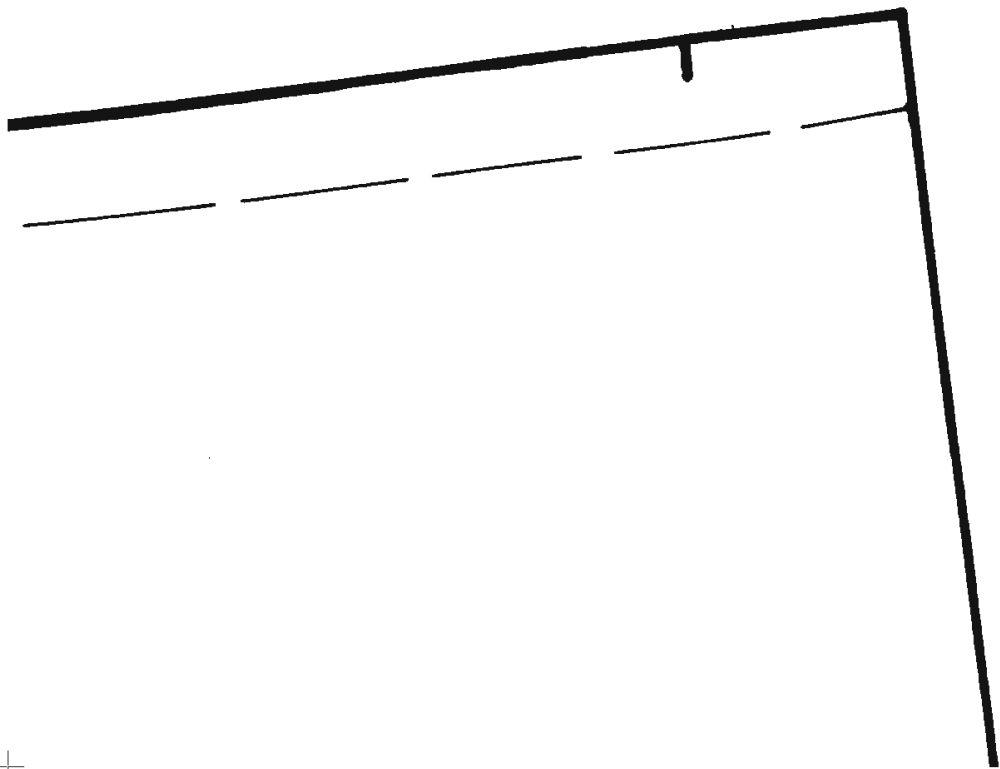



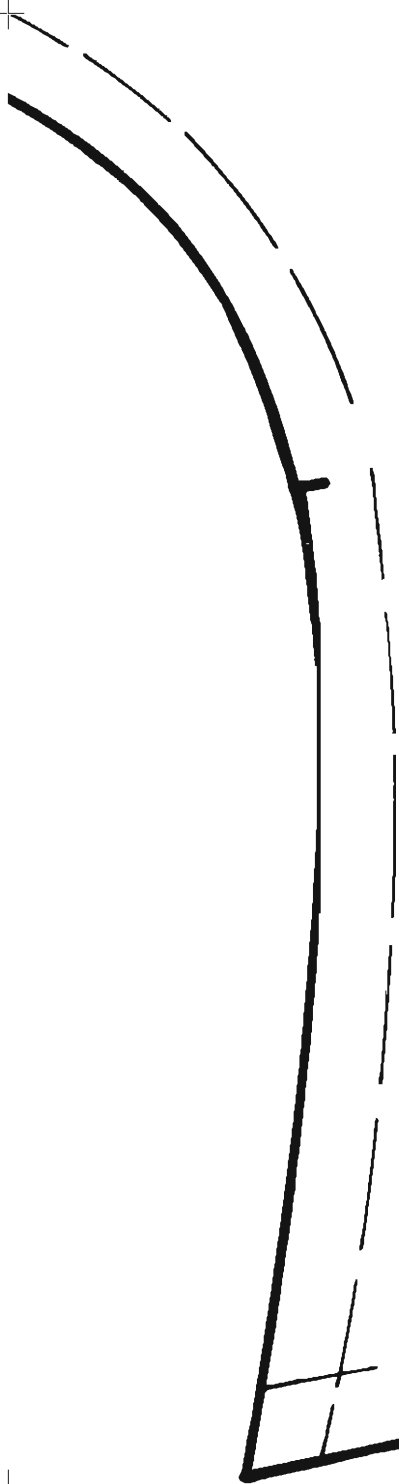

Stitch Line

Cut Line

Front Face: Cut 2

ONE RIGHT AND ONE LEFT

Size 38

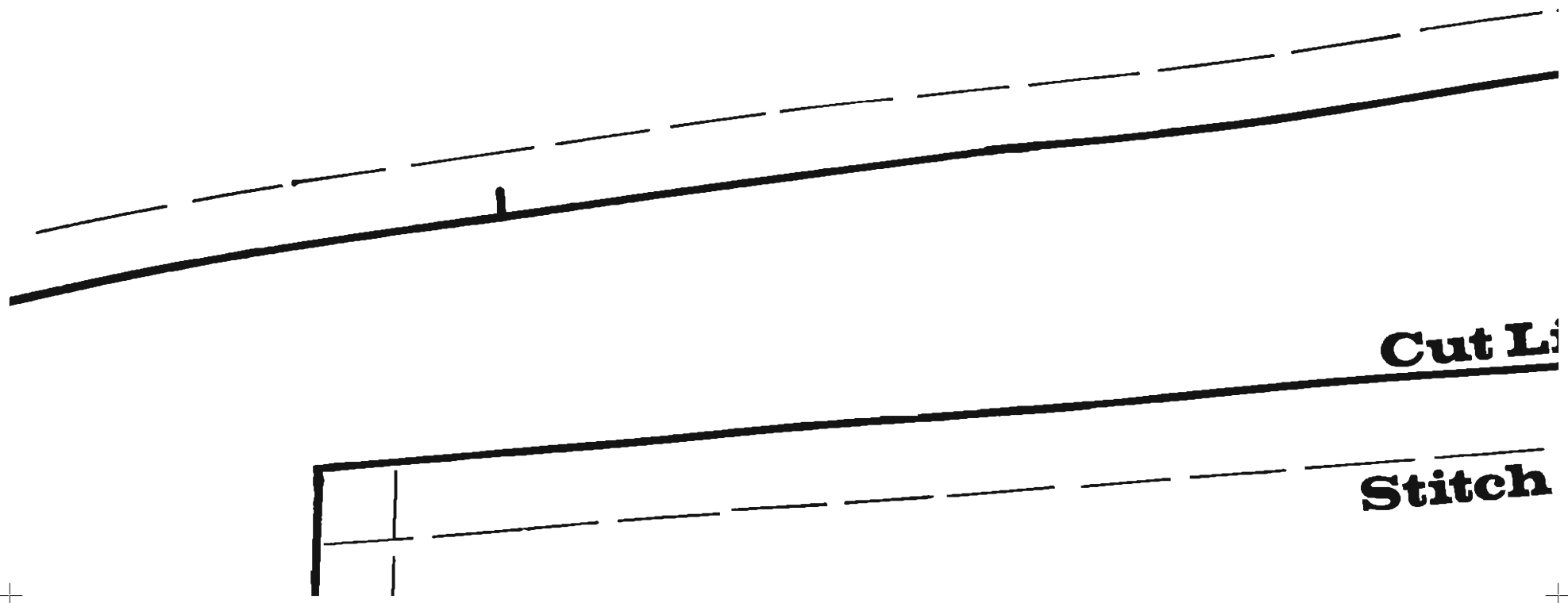

ing

3

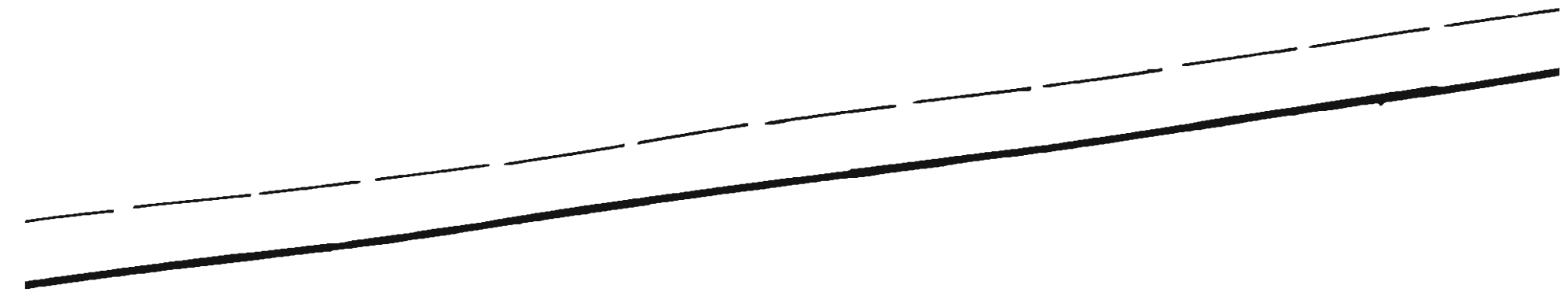

ine

Line

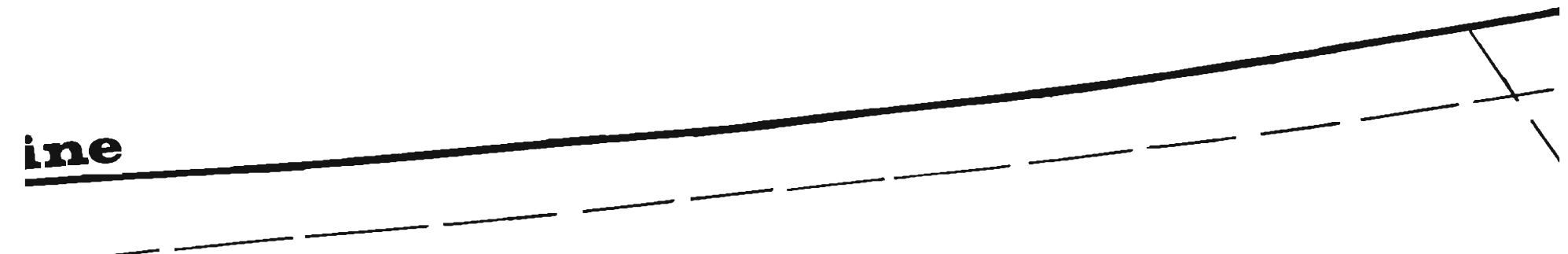

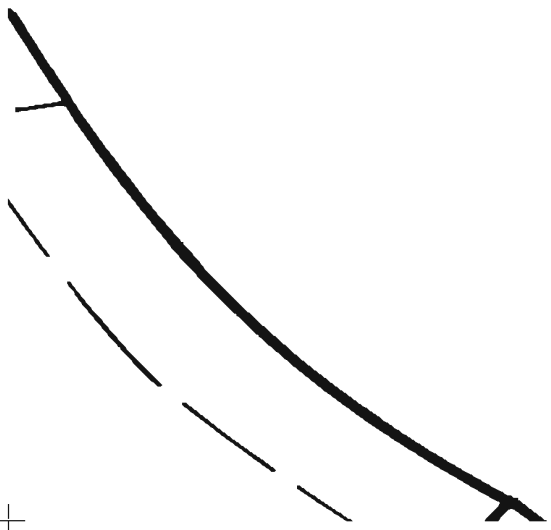

Men's Top Coat Pattern Pieces

Size 38



Sleeve Lining Cut 2

ONE RIGHT AND ONE LEFT

Size 38

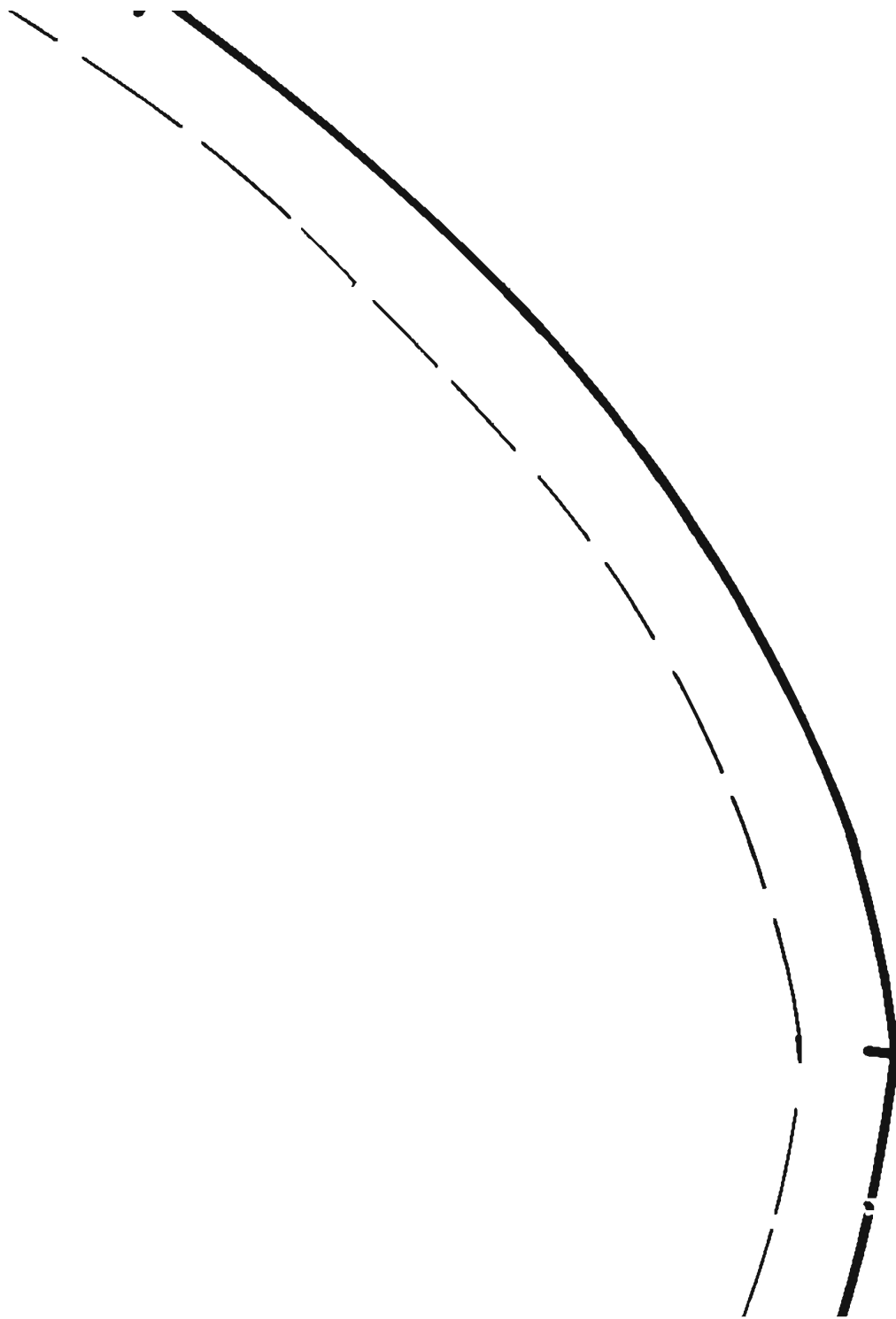

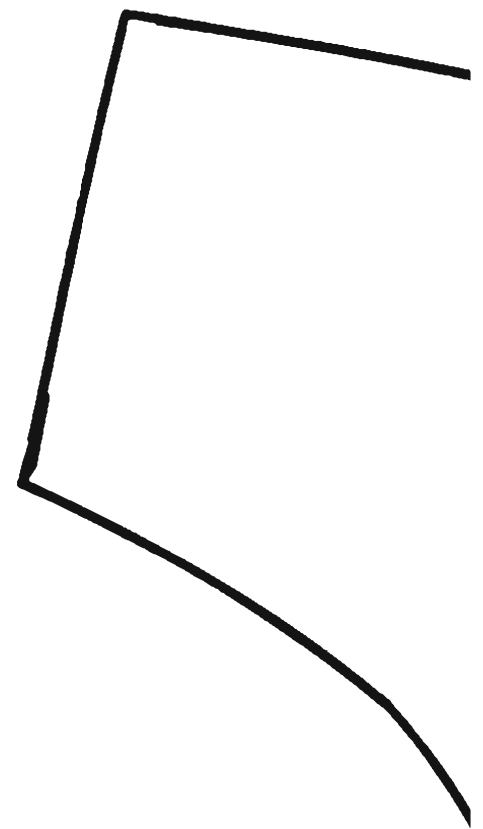

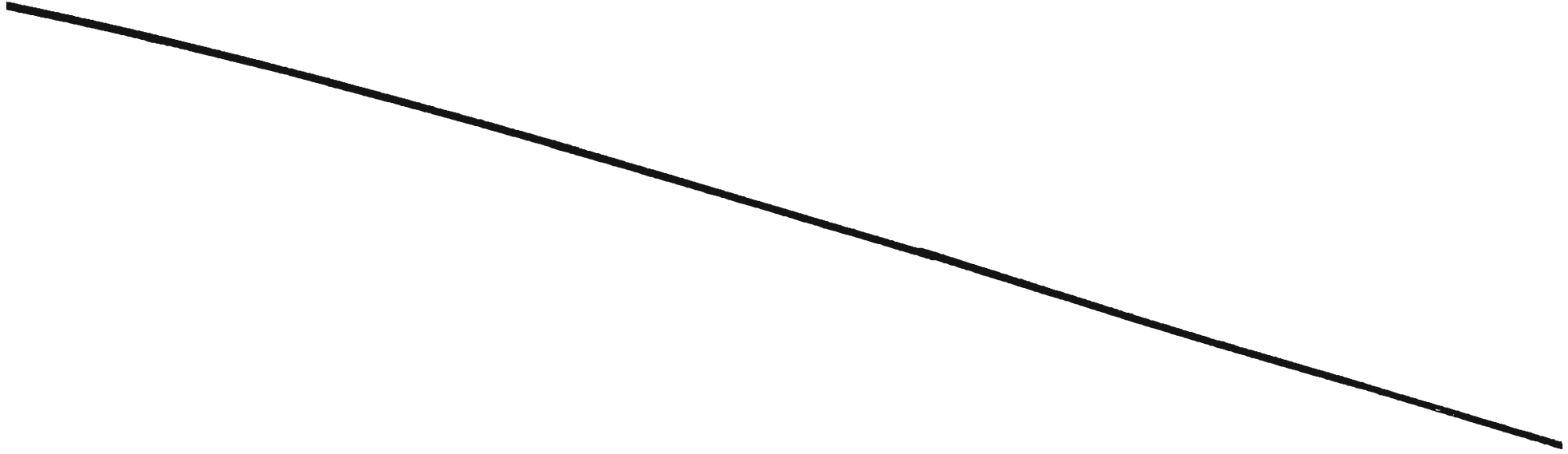

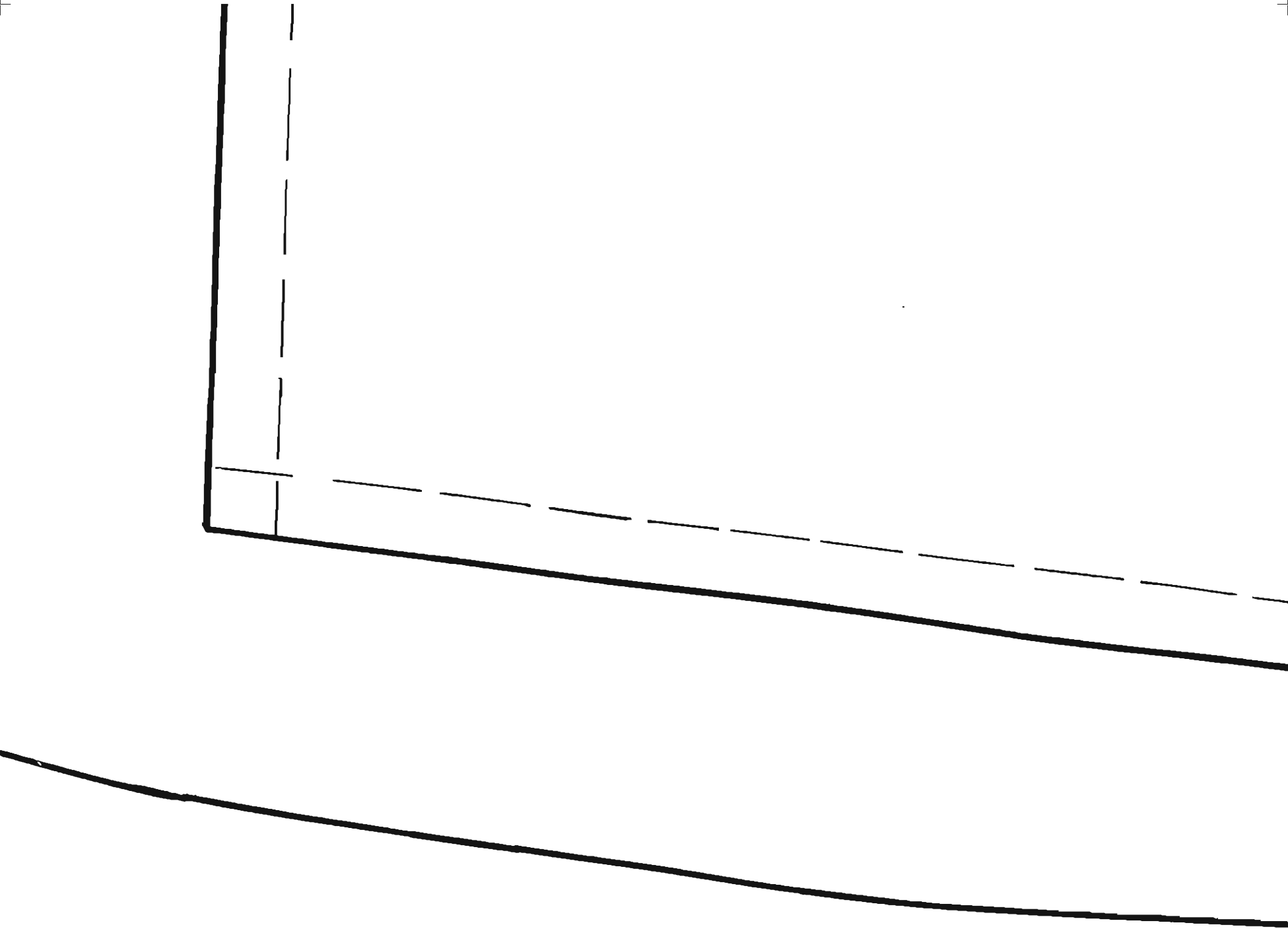

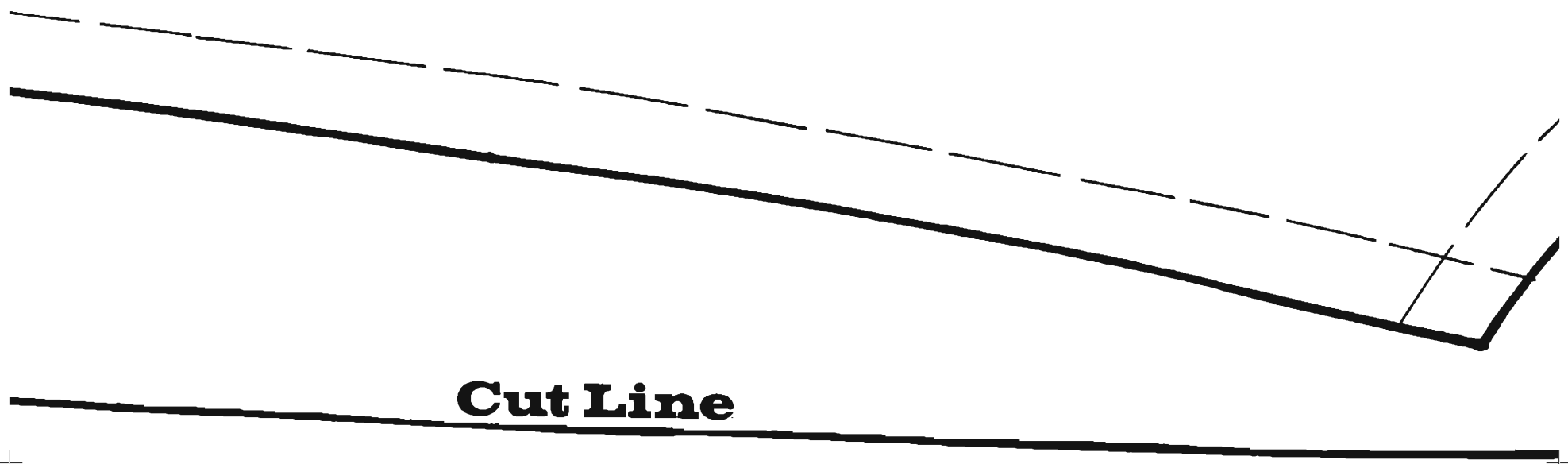

Cut Line

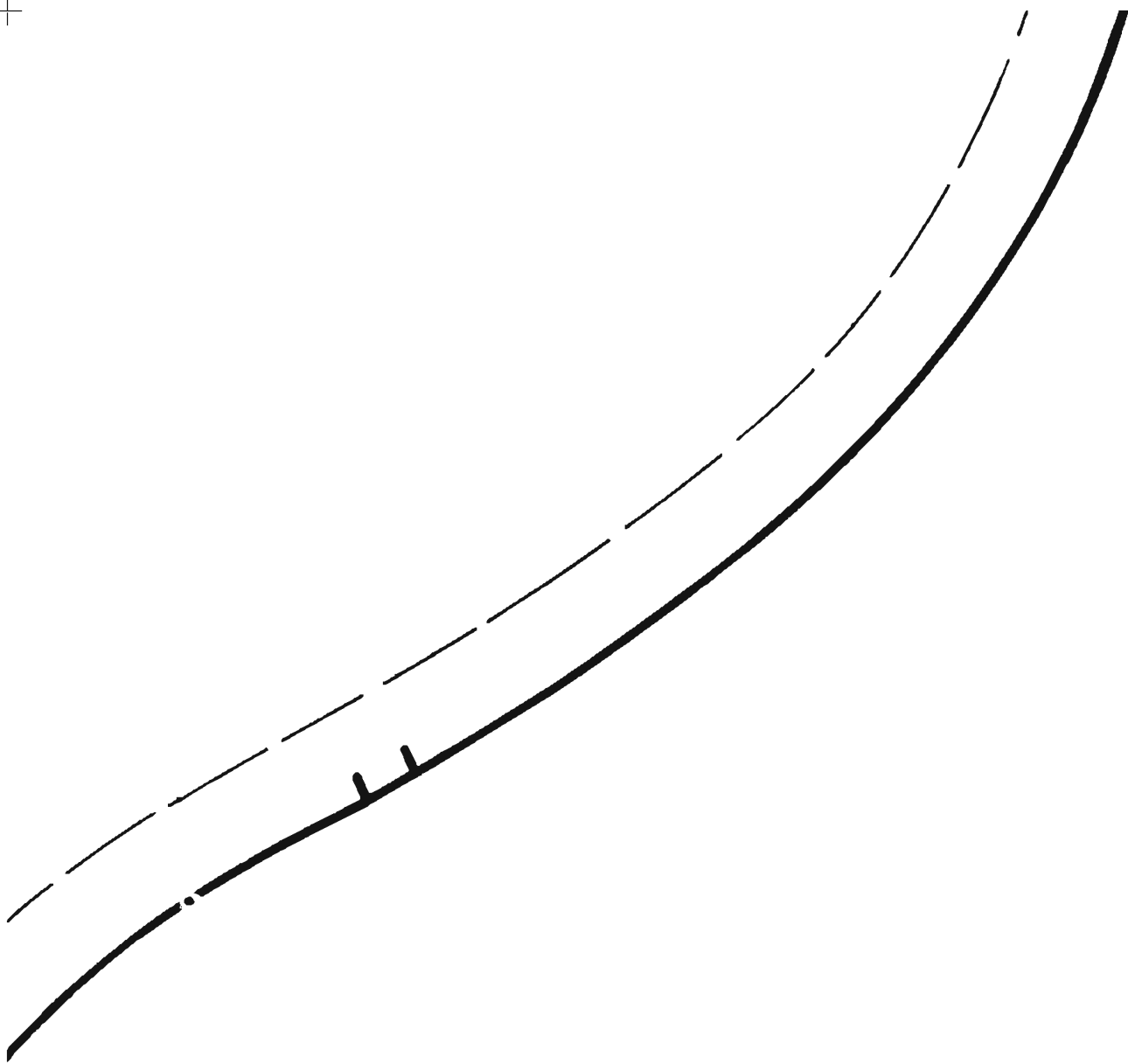



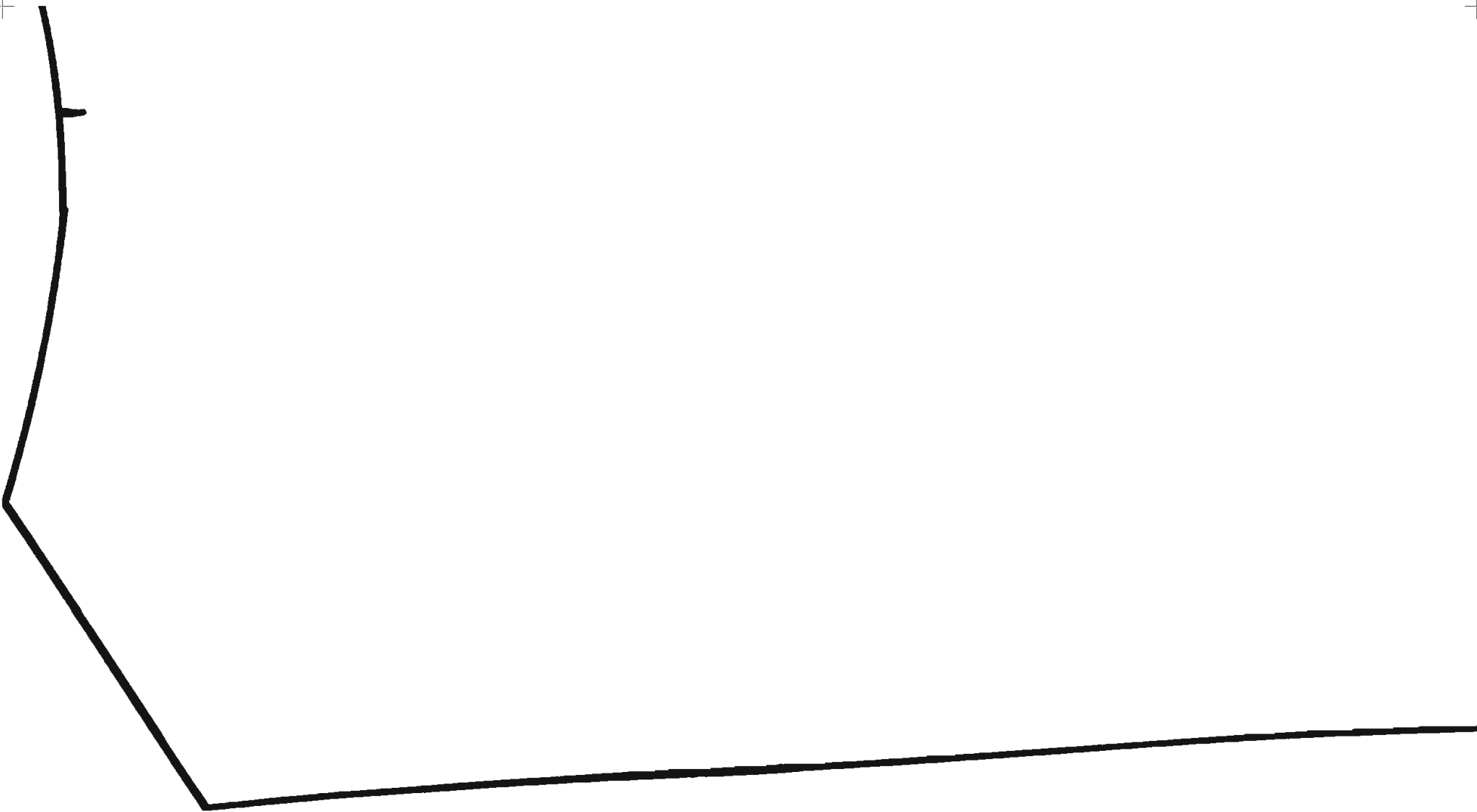

Front Inte

Cut2

ONE RIGHT AND ONE

Size

erfacing

2

LEFT

38

—



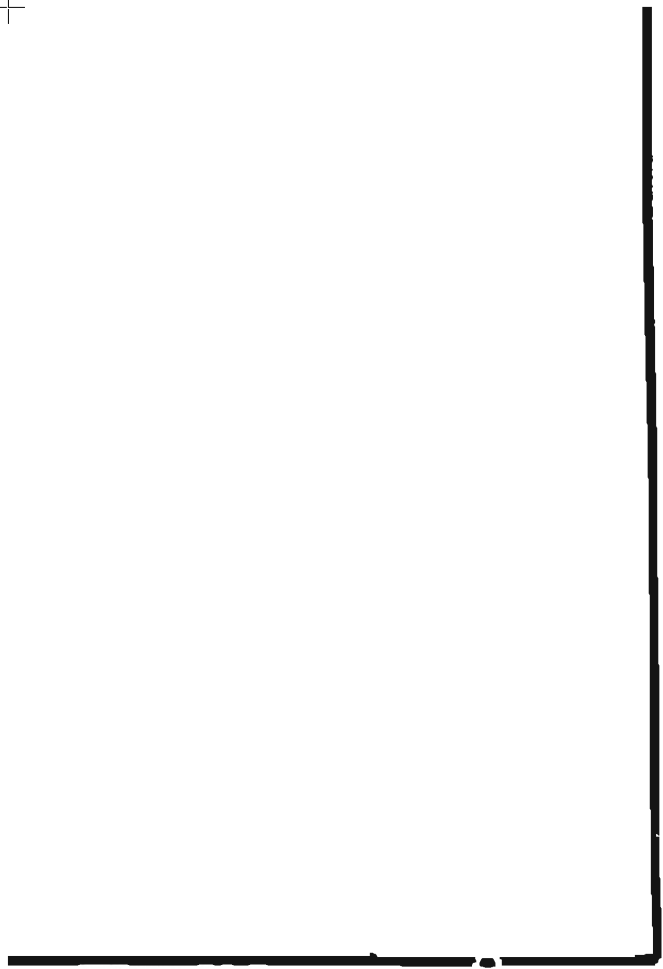

**Men's Top Coat
Pattern Pieces
Size 38**

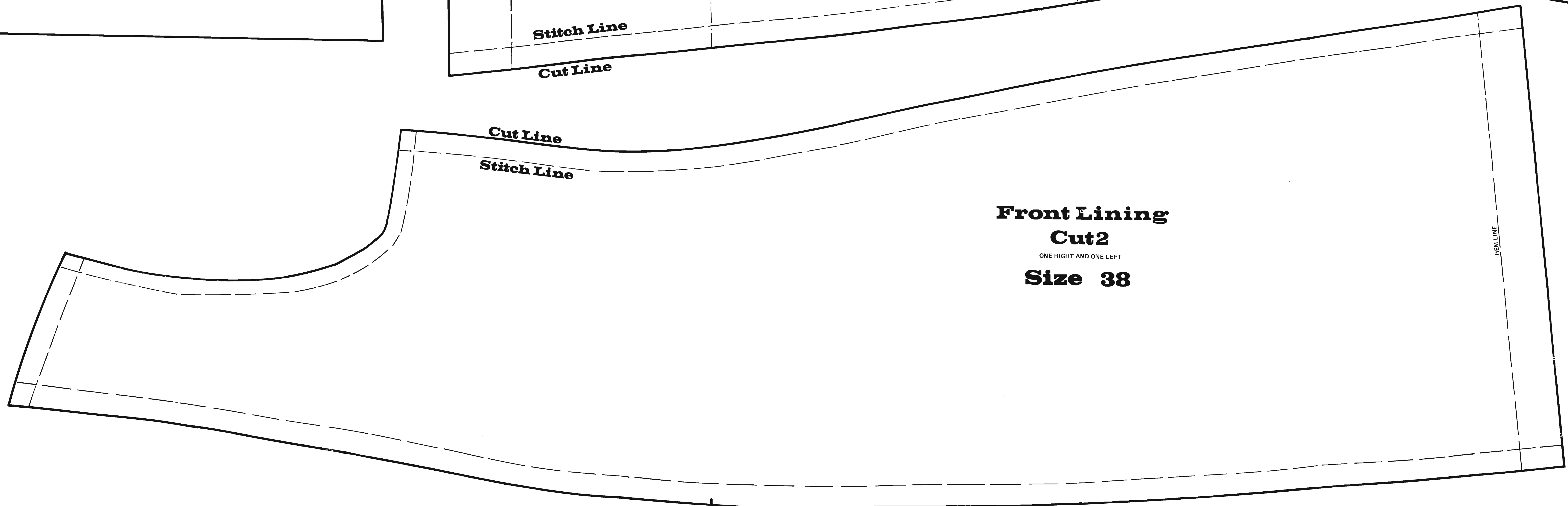
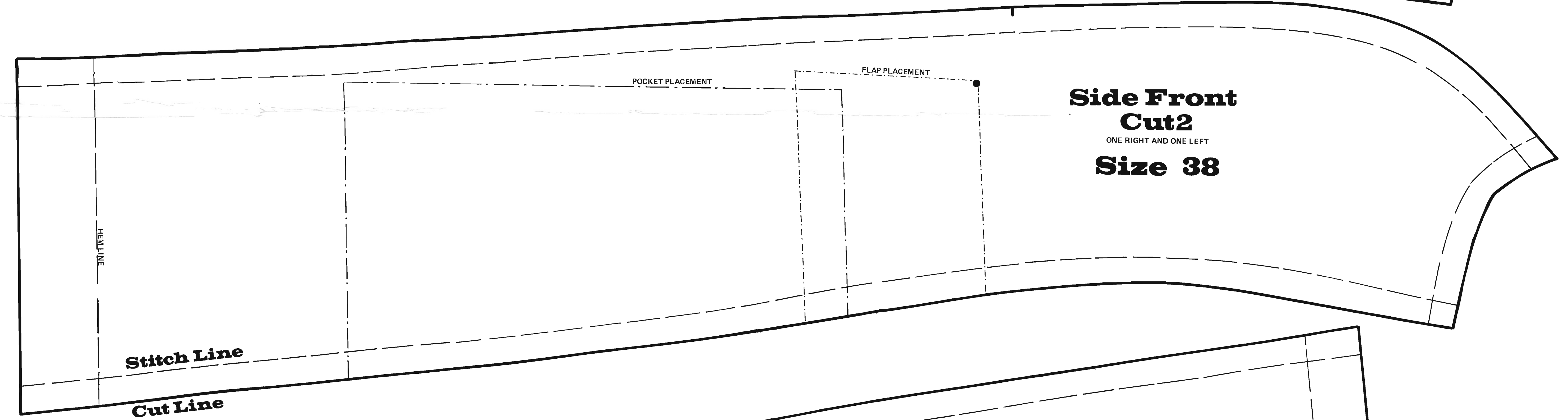
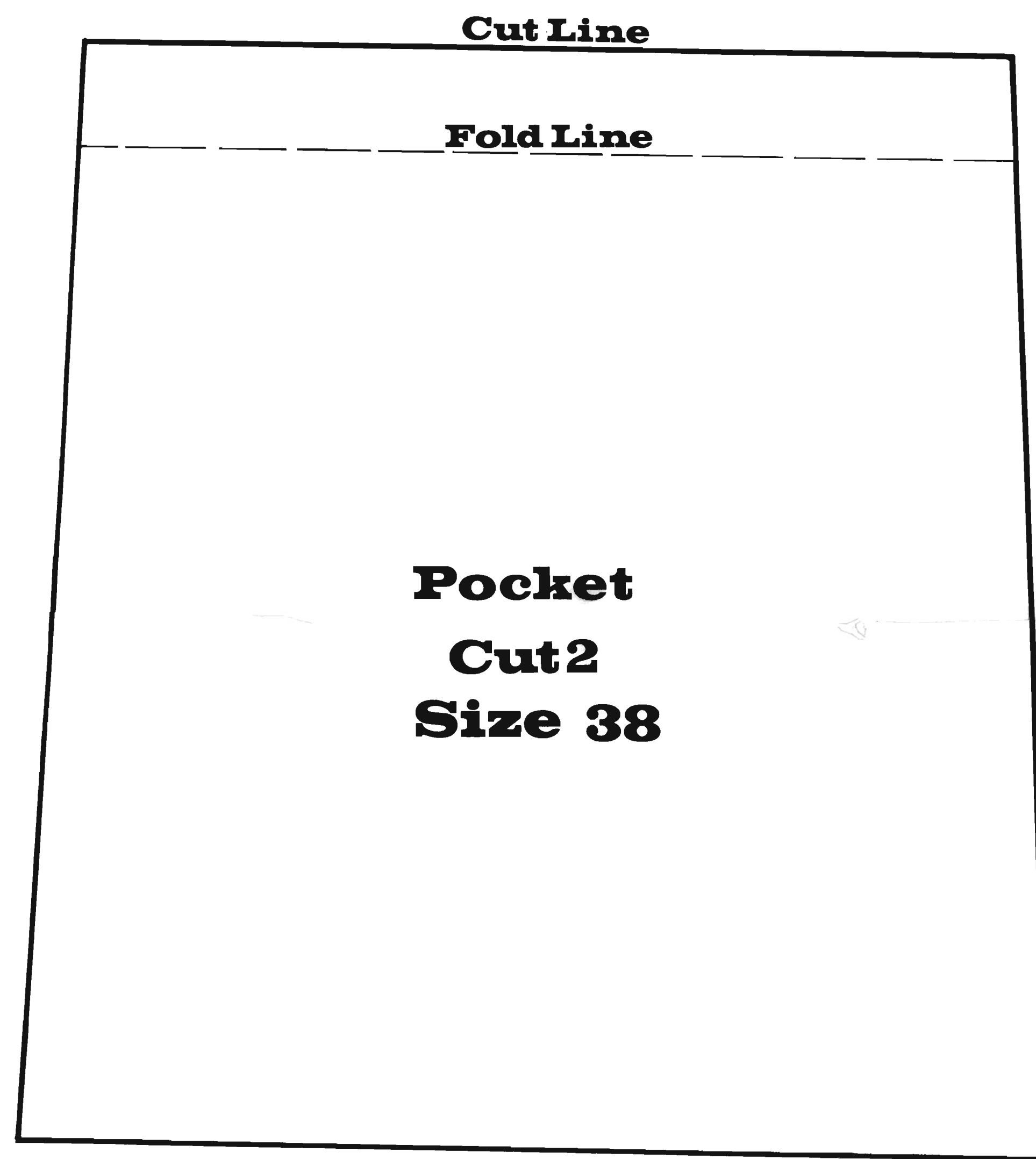
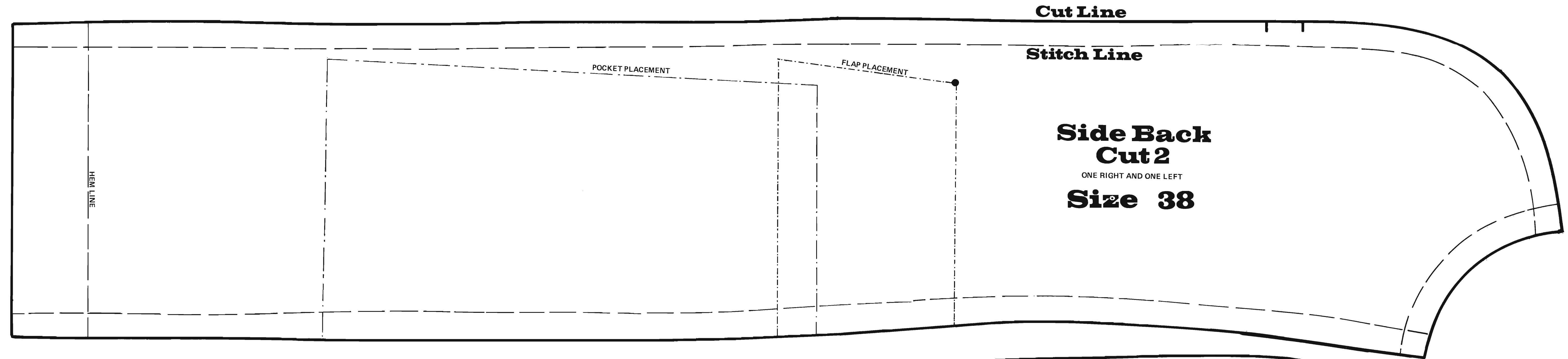
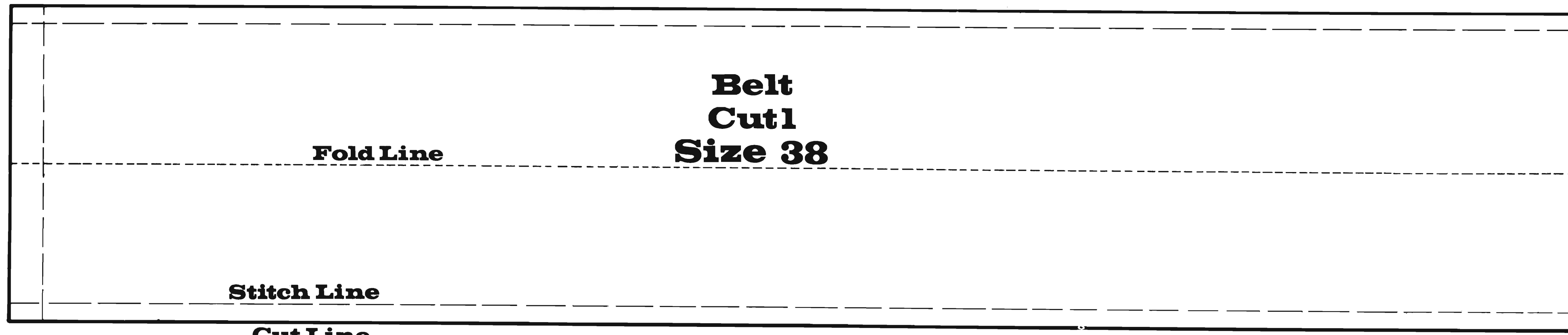

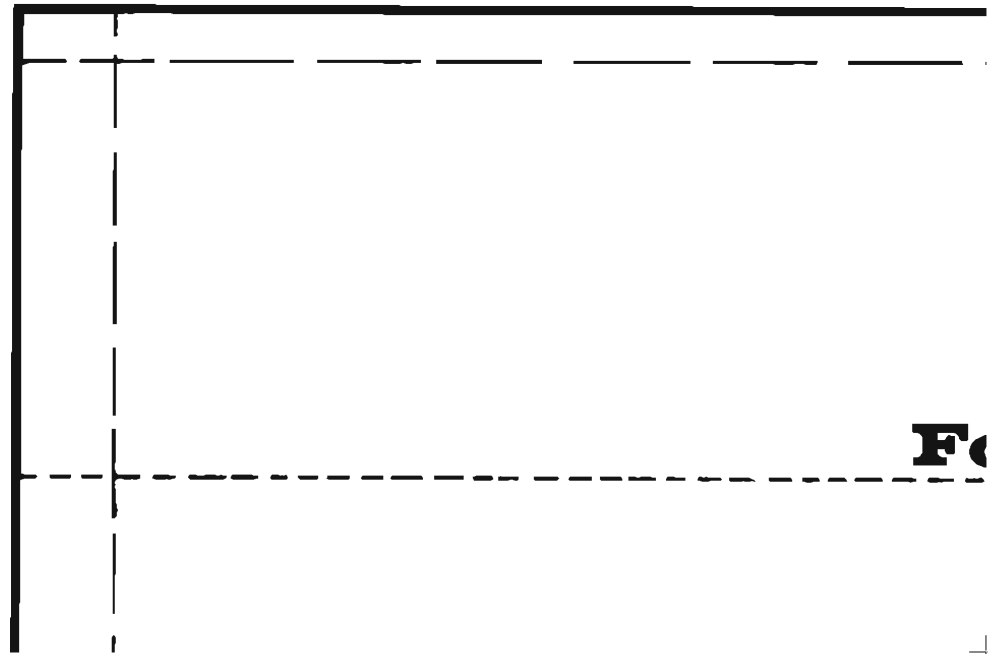

Fc

**Belt
Cut1
Size 38**

old Line

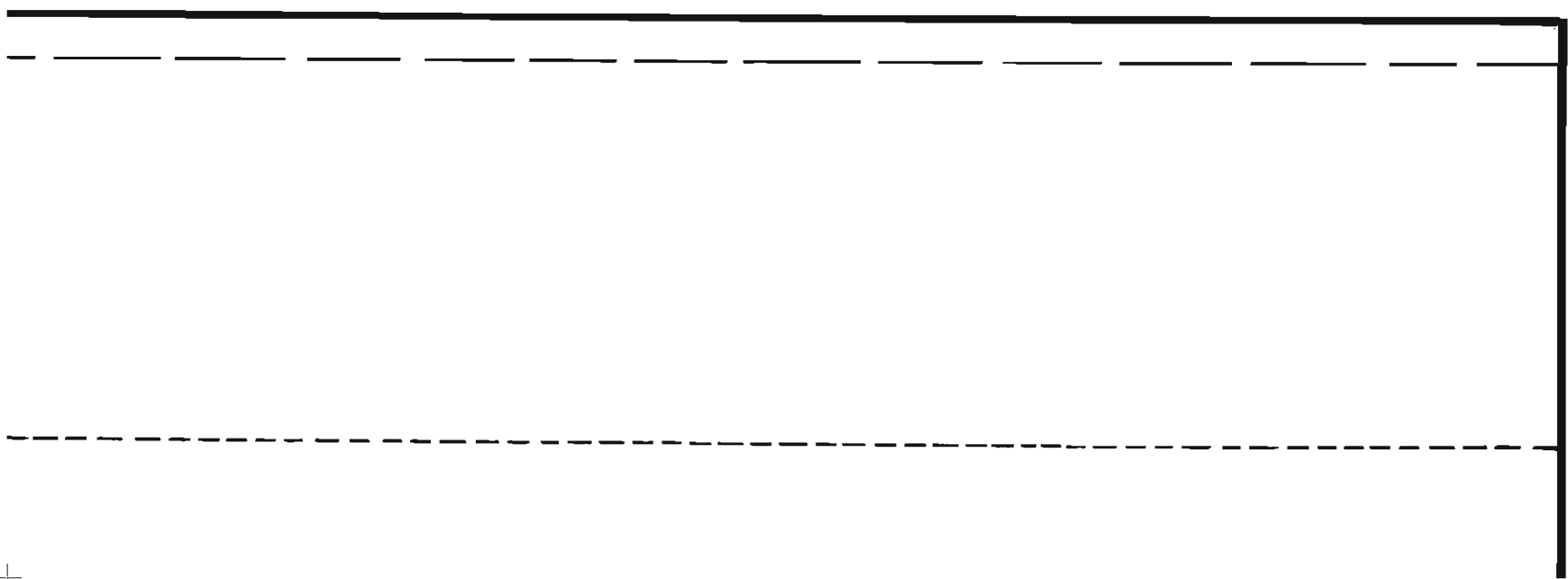

**Men's Top Coat
Pattern Pieces
Size 38**



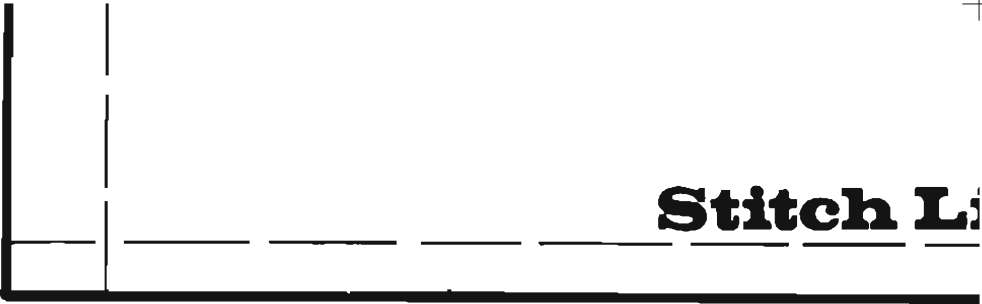

Stitch Li

Cut Li

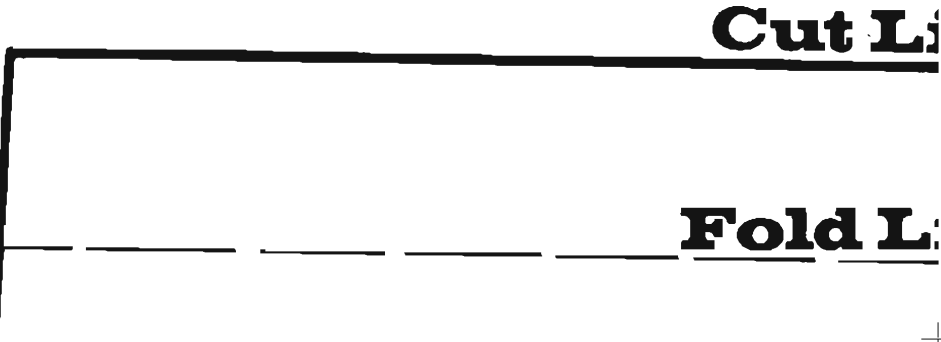

Cut Li

Fold Li

ine

ne

ine

ine

HEM LINE

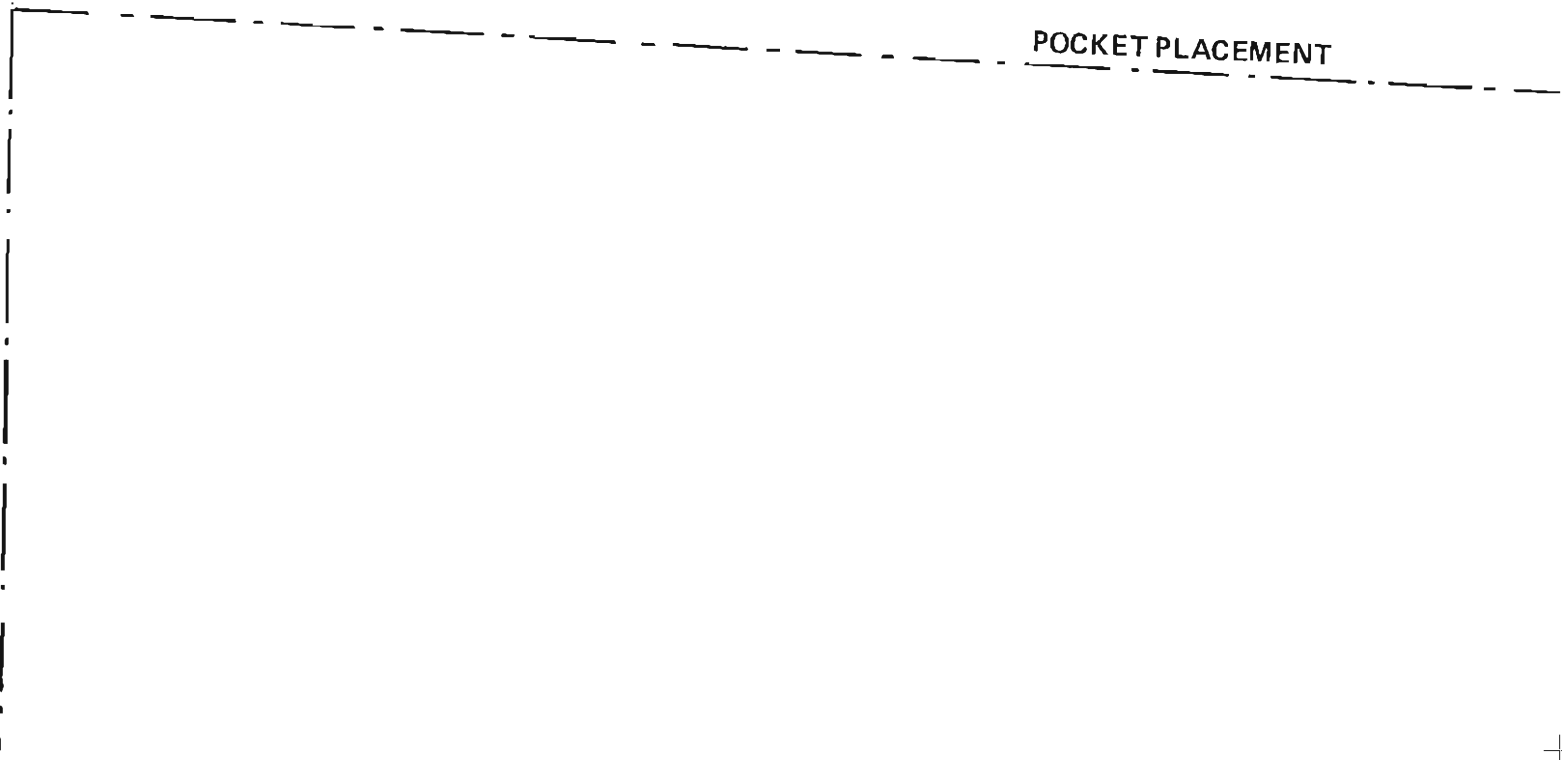

POCKET PLACEMENT

Cut Line

Stitch Line

FLAP PLACEMENT

**Side Back
Cut 2**

ONE RIGHT AND ONE LEFT

Size 38

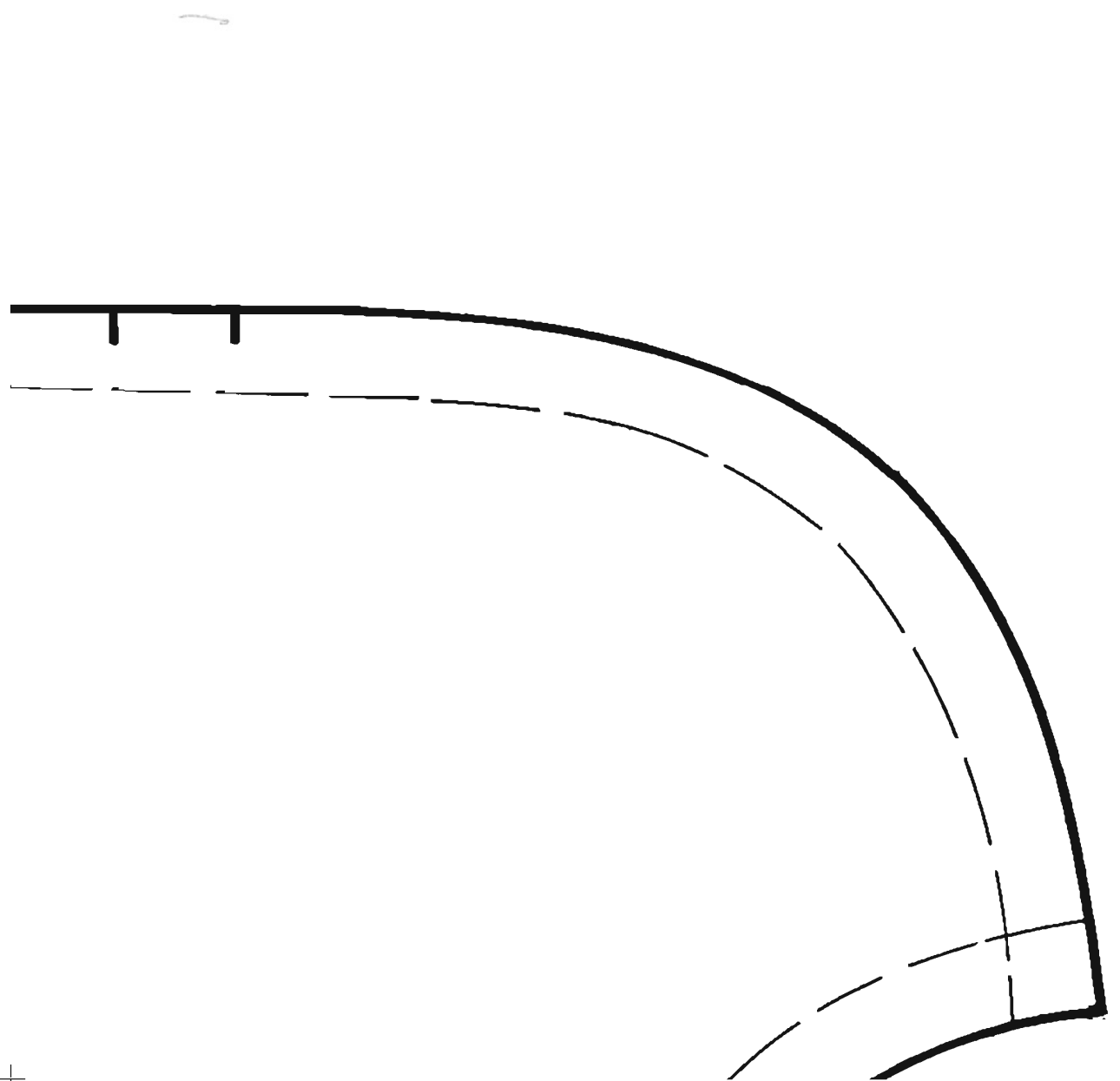

Pocke
Cut2
Size

et

2

38

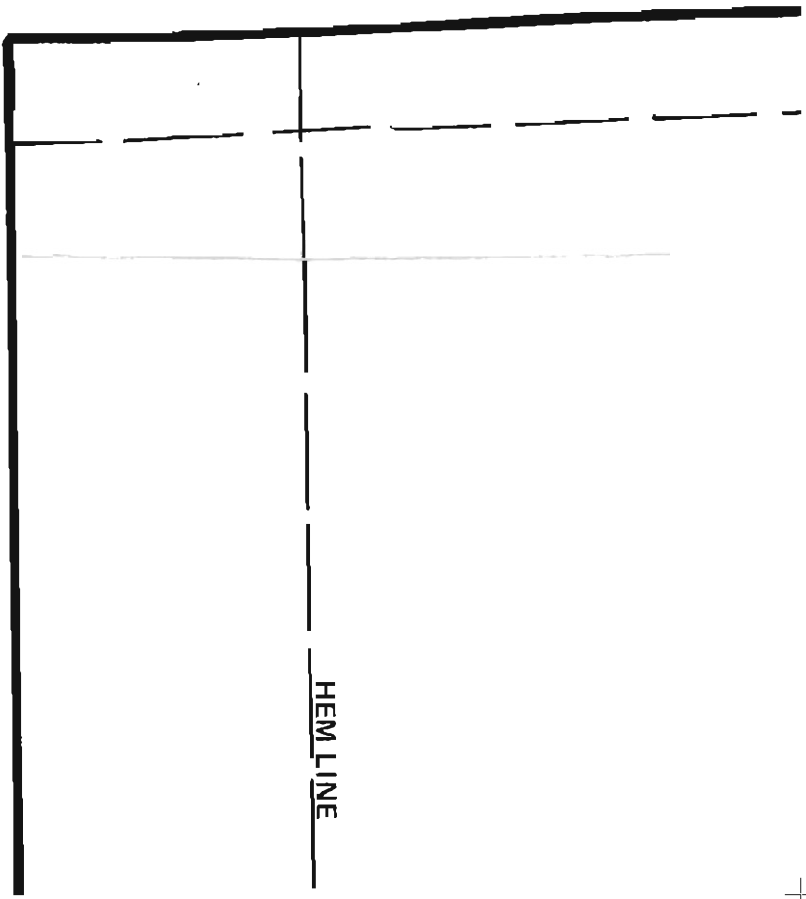

HEM LINE

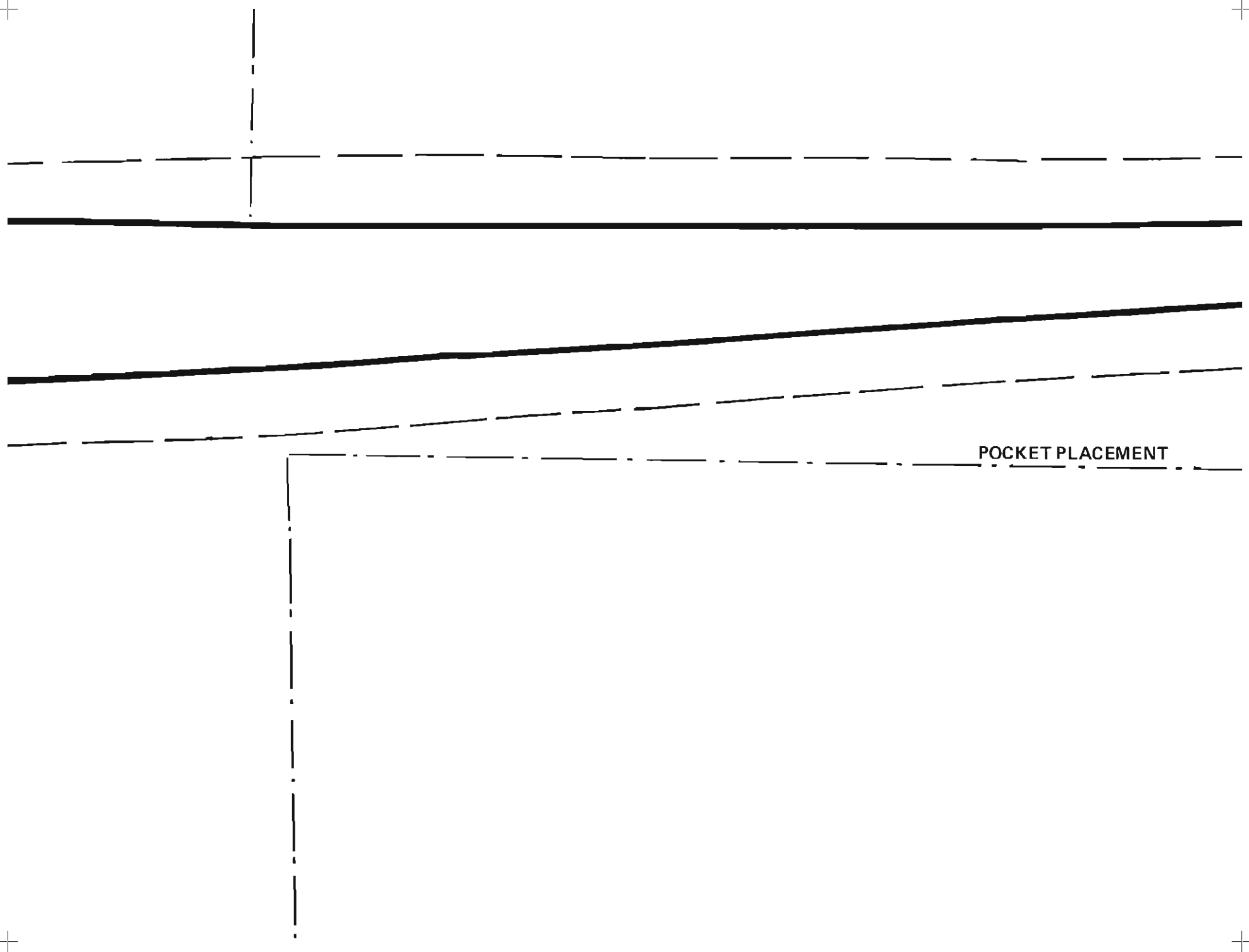

POCKET PLACEMENT

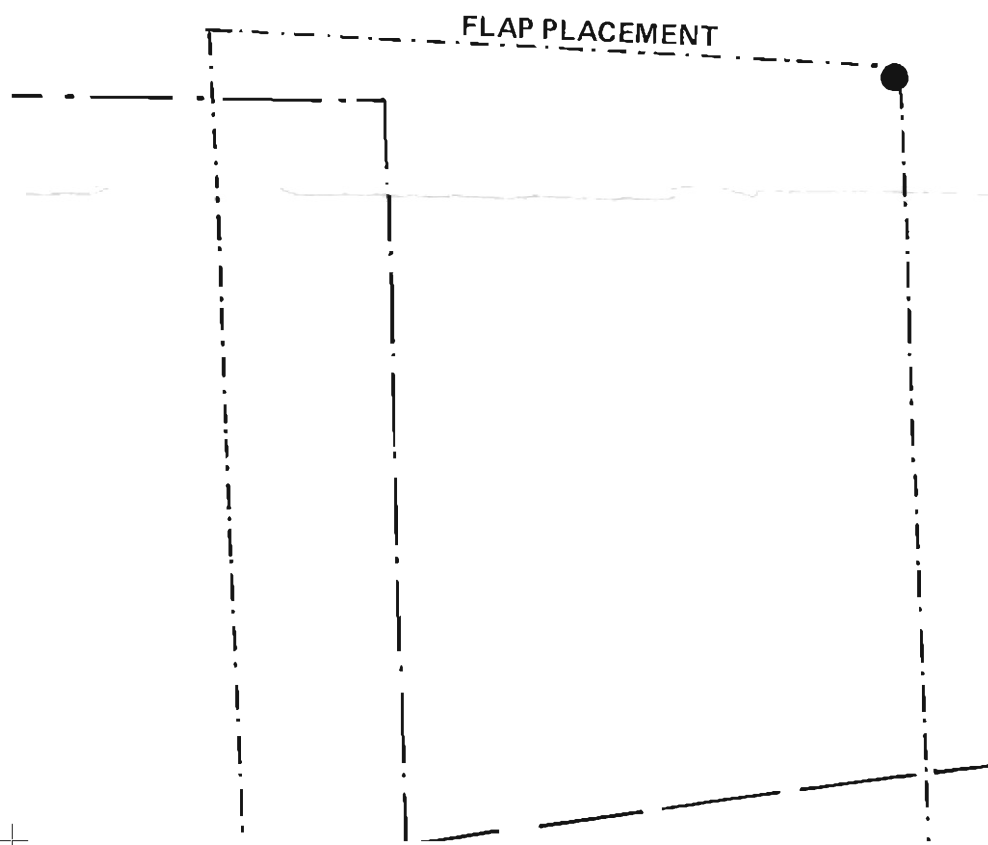
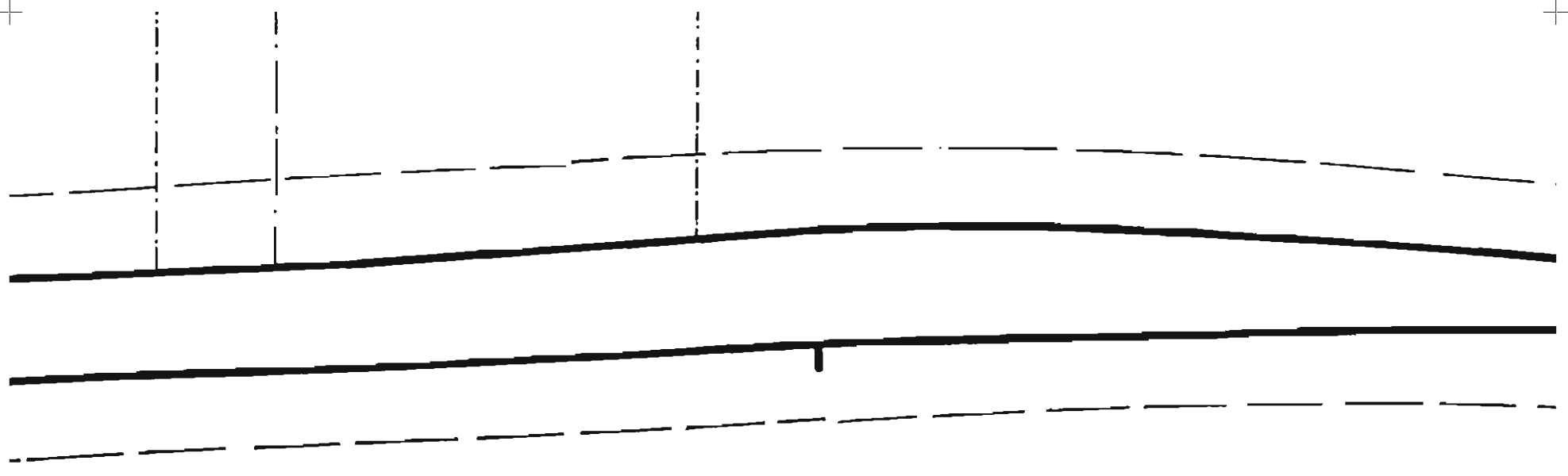

Side Front
Cut2
ONE RIGHT AND ONE LEFT
Size 38

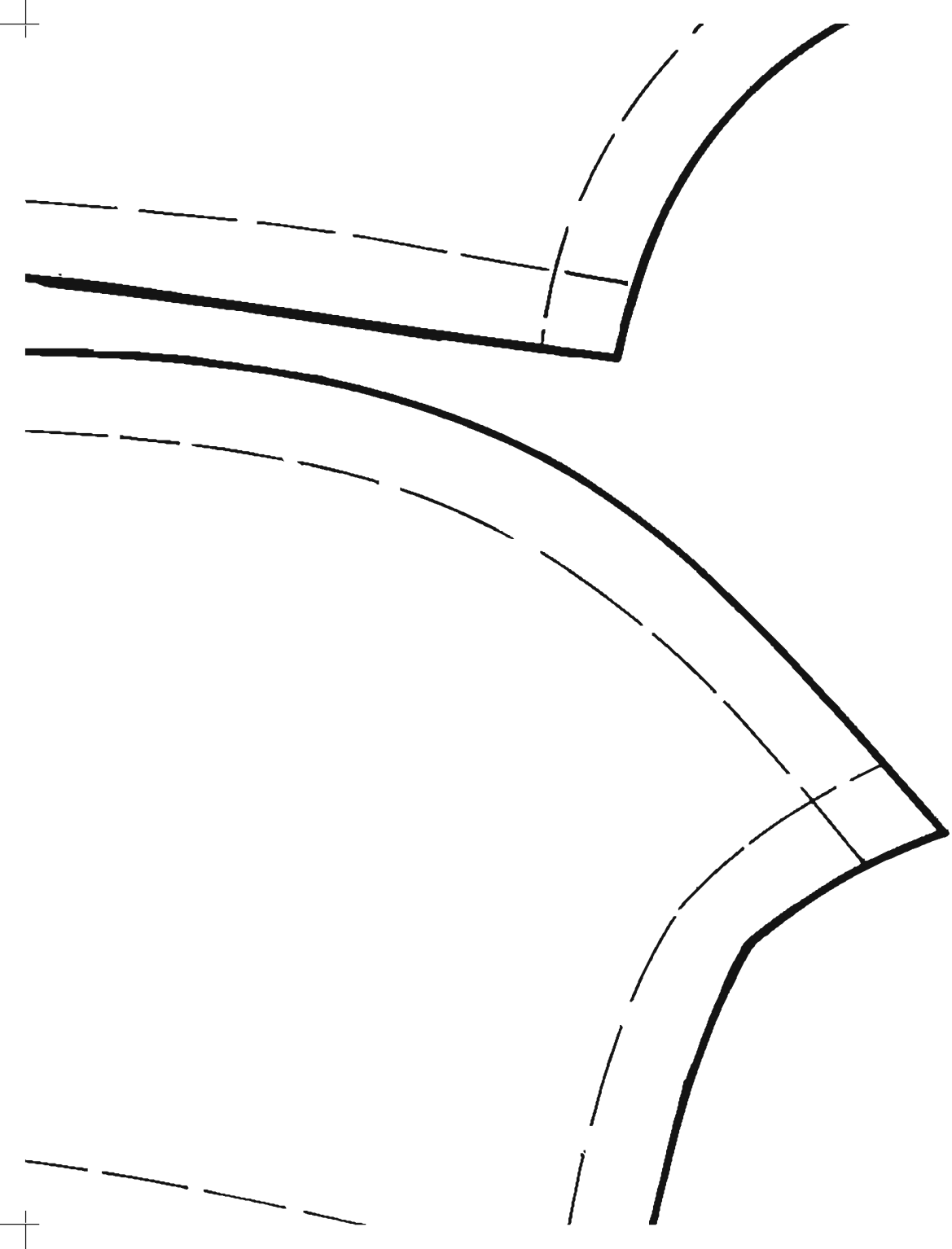



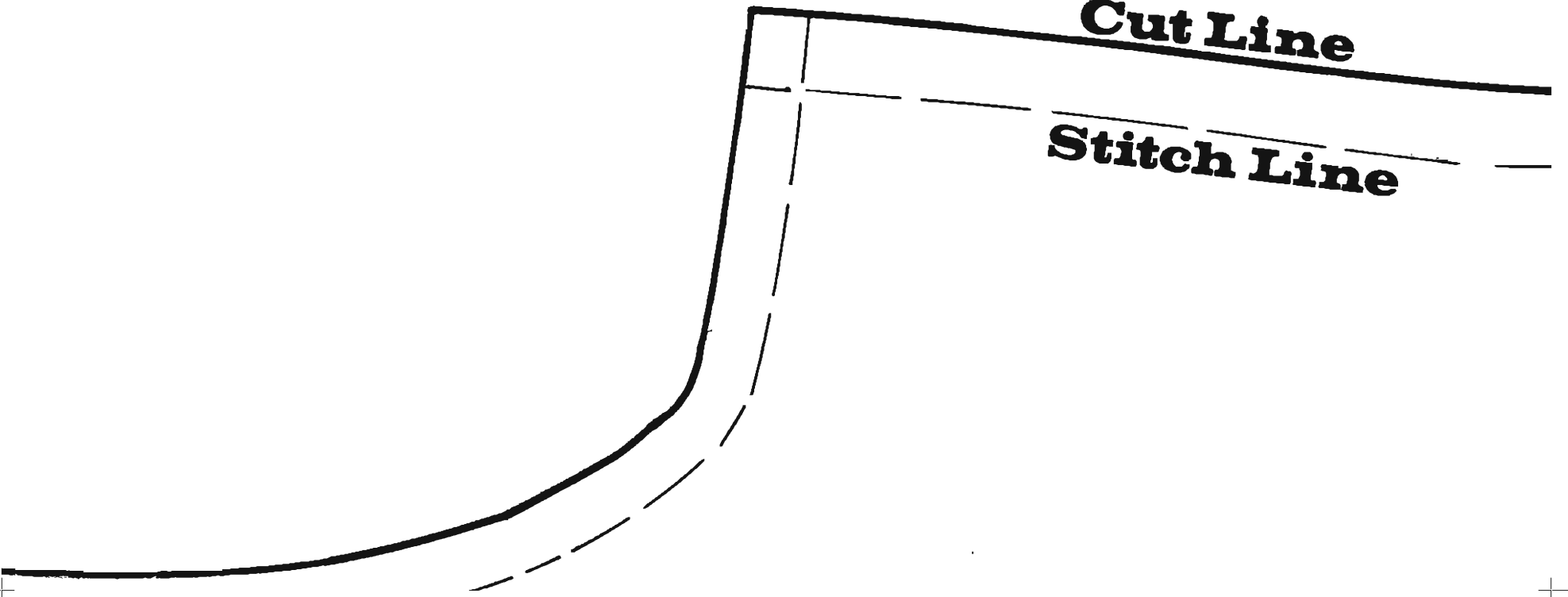
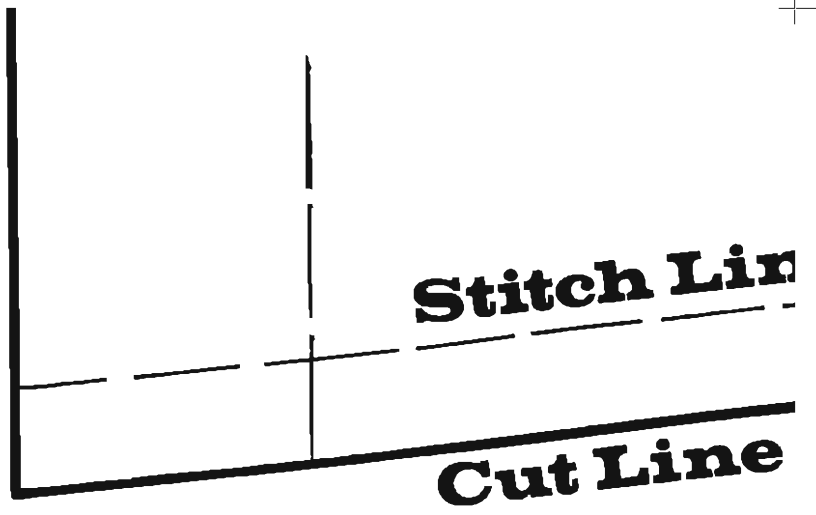

le

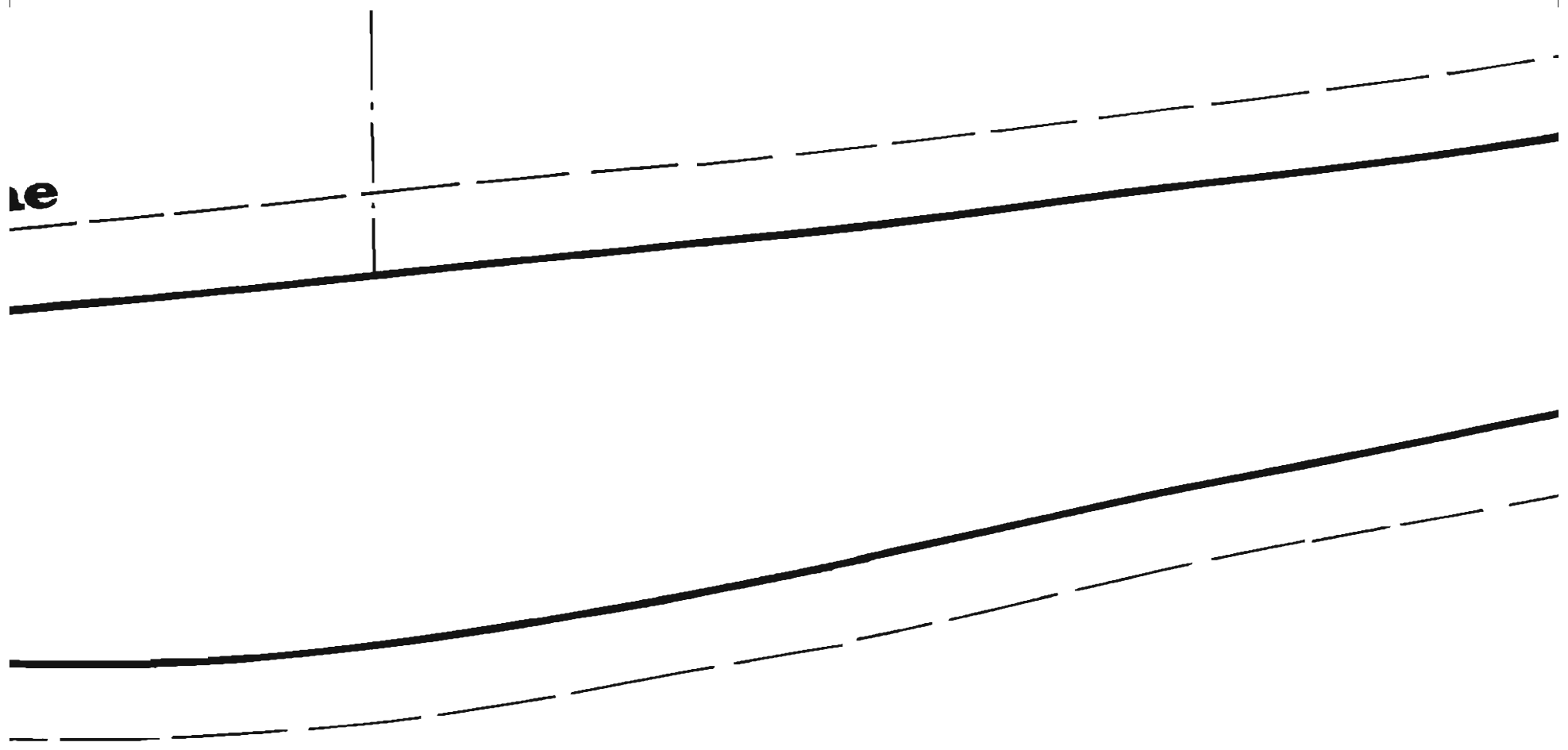

Fr

l

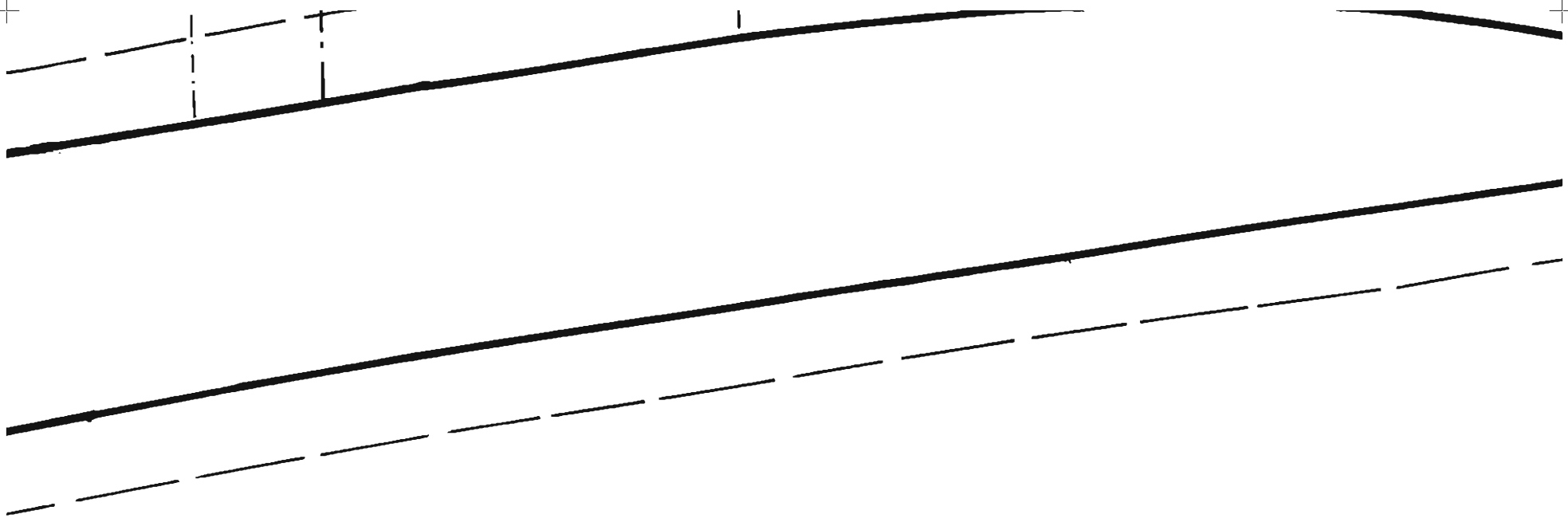

ont Lining

Cut2

ONE RIGHT AND ONE LEFT

Size 38

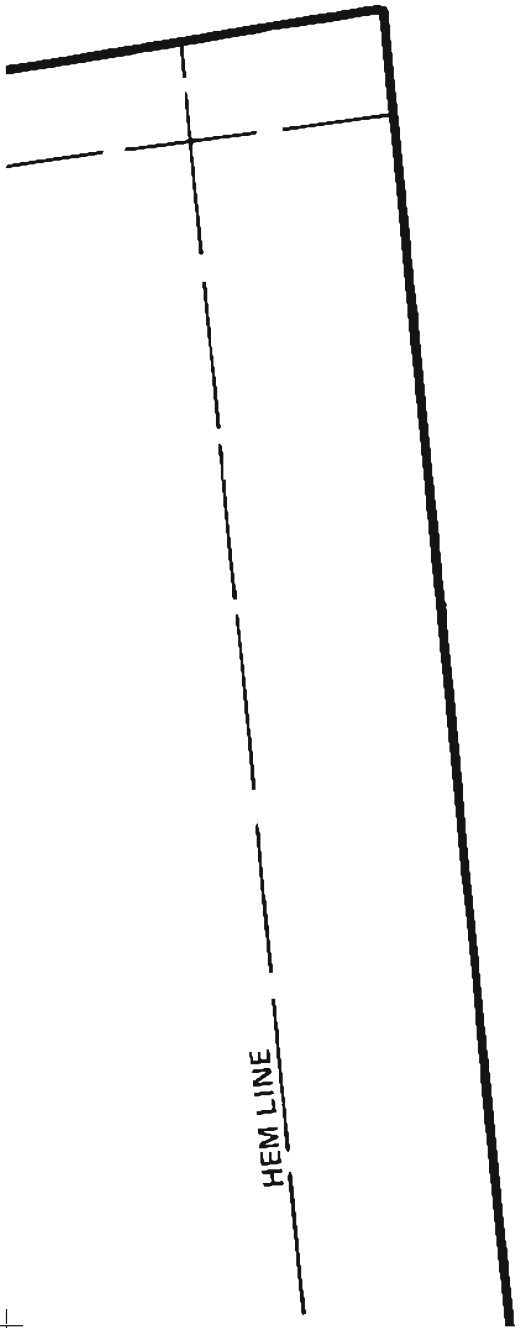

HEM LINE

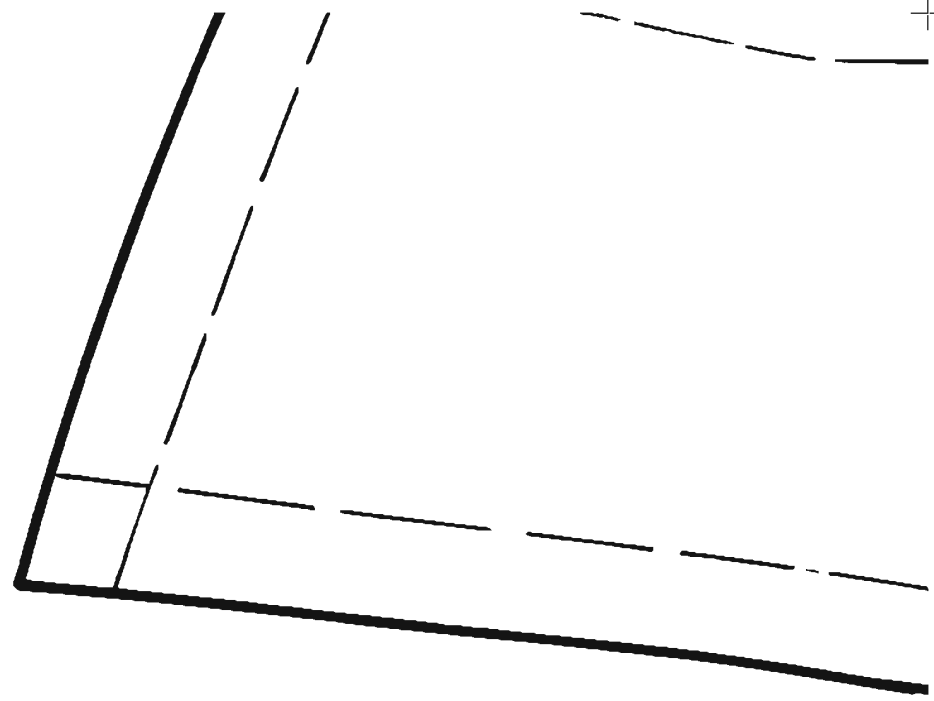

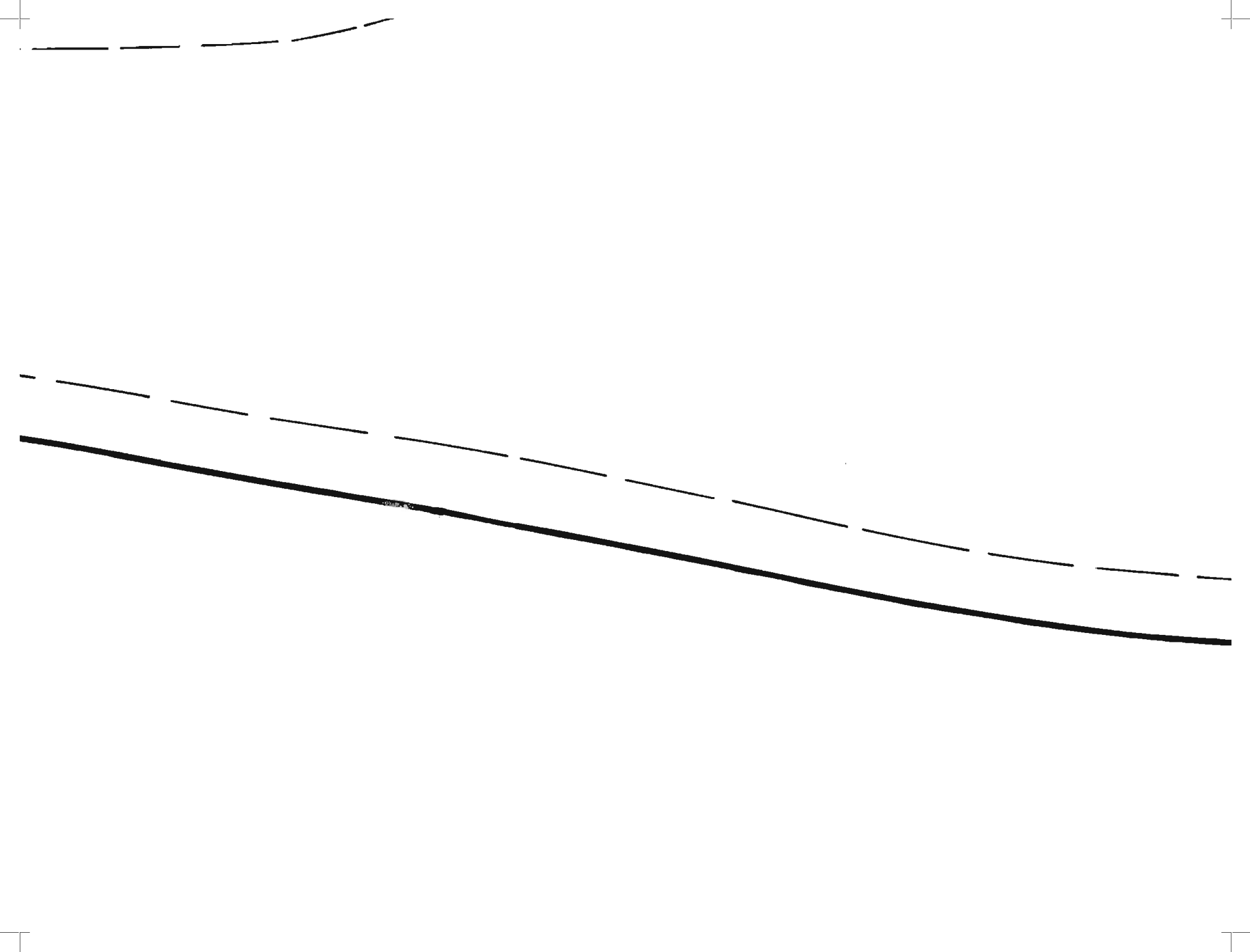



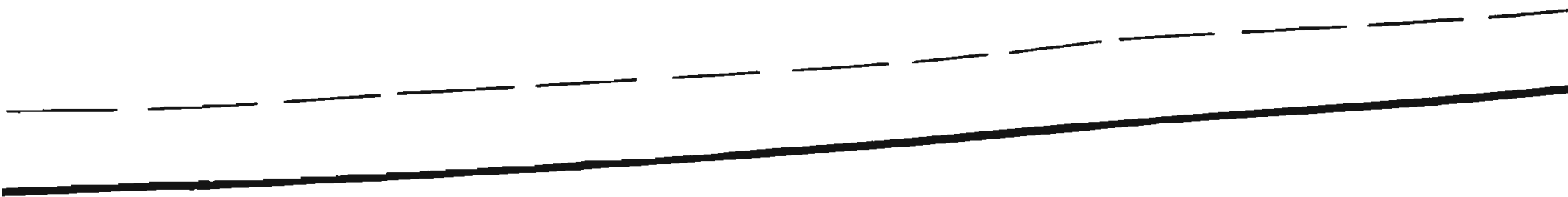



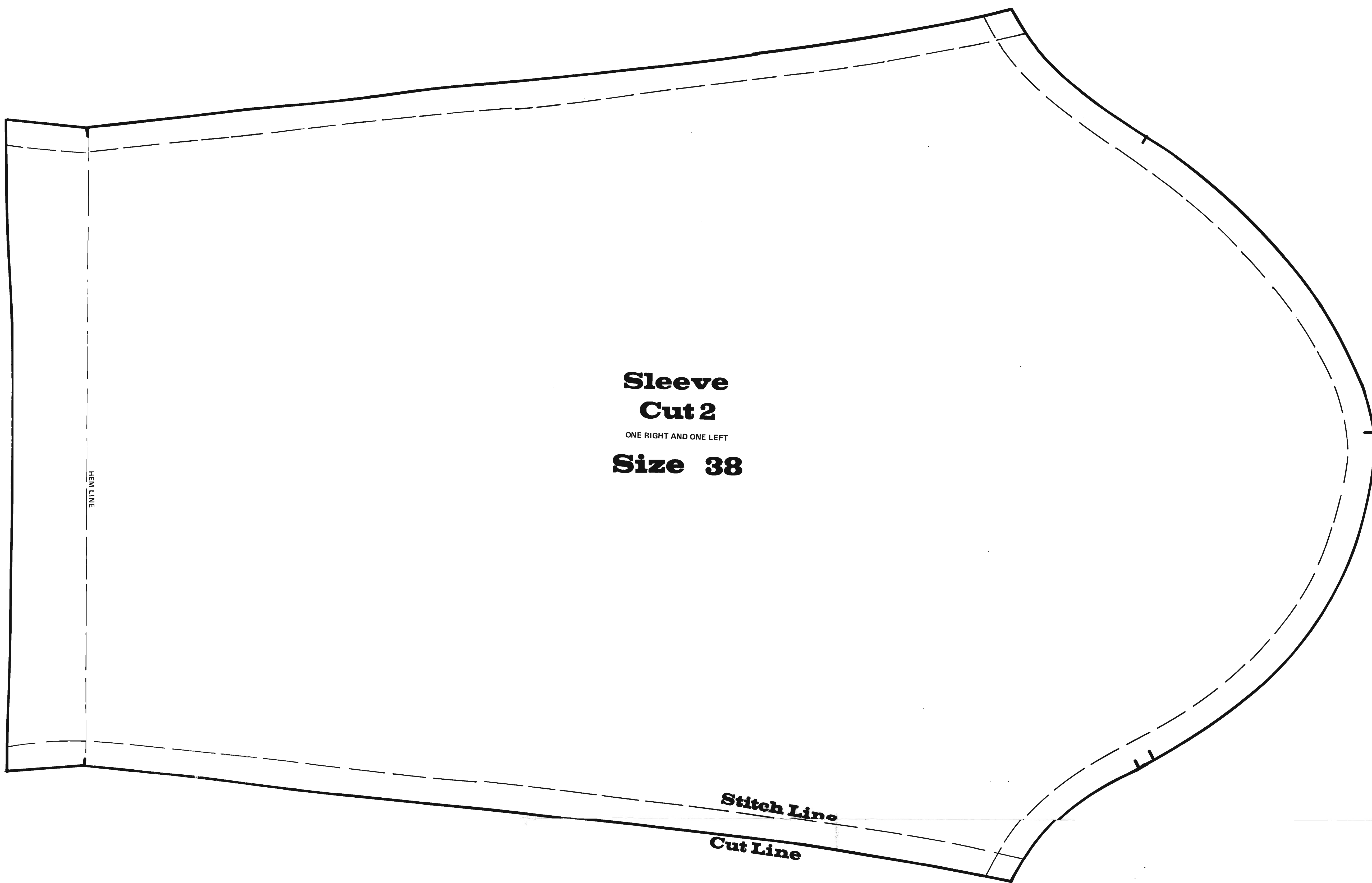

**Sleeve
Cut 2**
ONE RIGHT AND ONE LEFT
Size 38

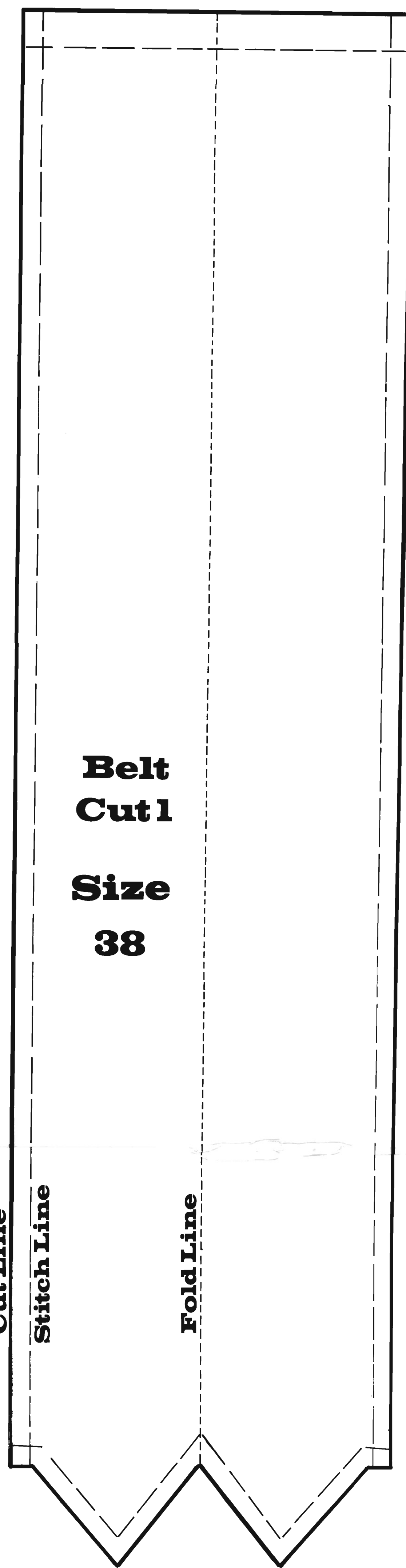

**Belt
Cut 1**
**Size
38**

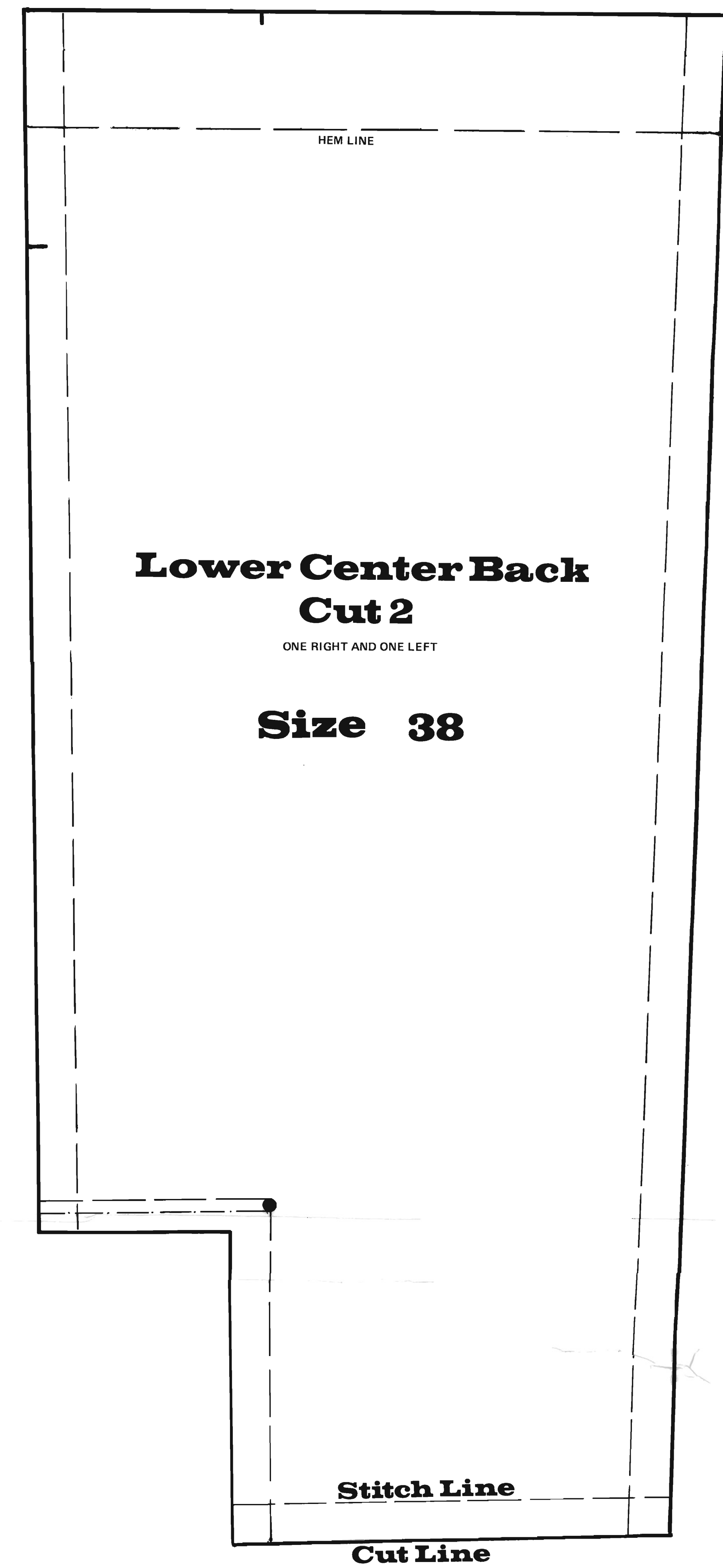

**Lower Center Back
Cut 2**
ONE RIGHT AND ONE LEFT
Size 38

**Men's Top Coat
Pattern Pieces
Size 38**

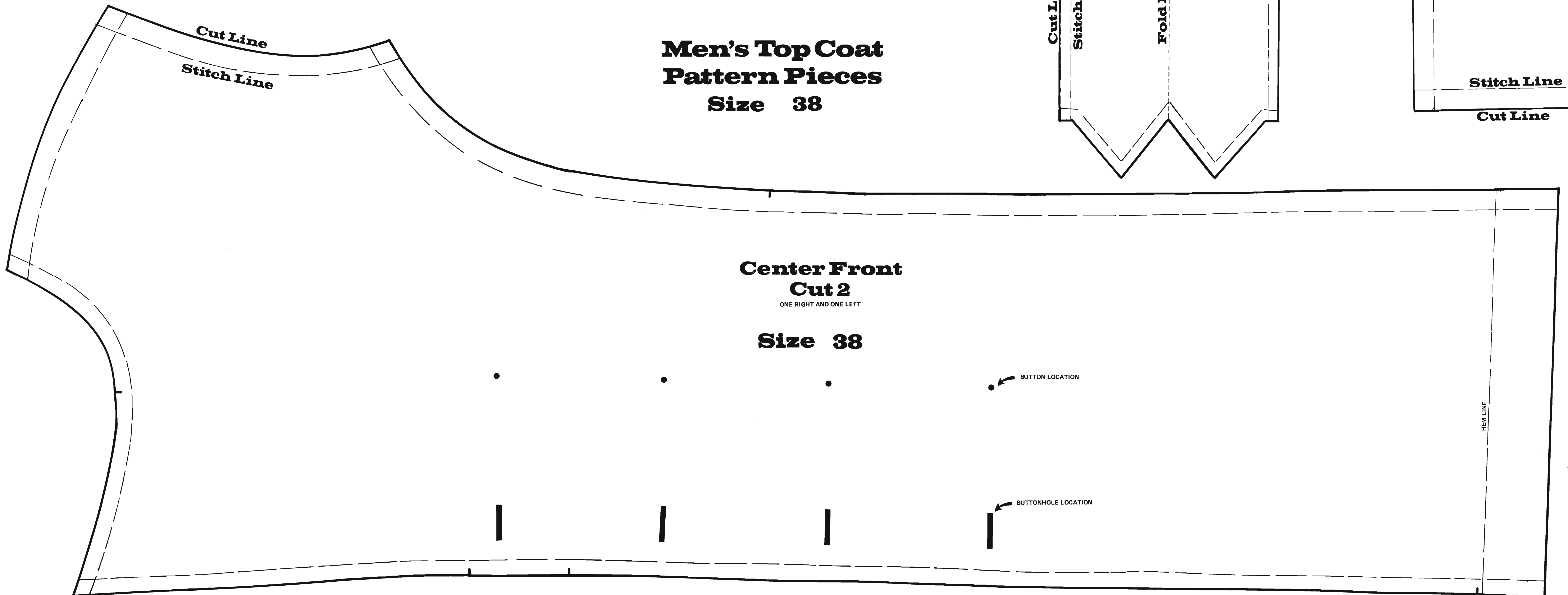

**Center Front
Cut 2**
ONE RIGHT AND ONE LEFT
Size 38

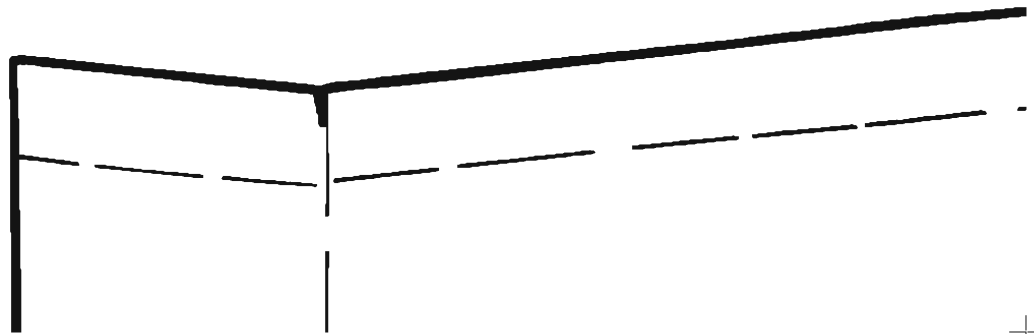

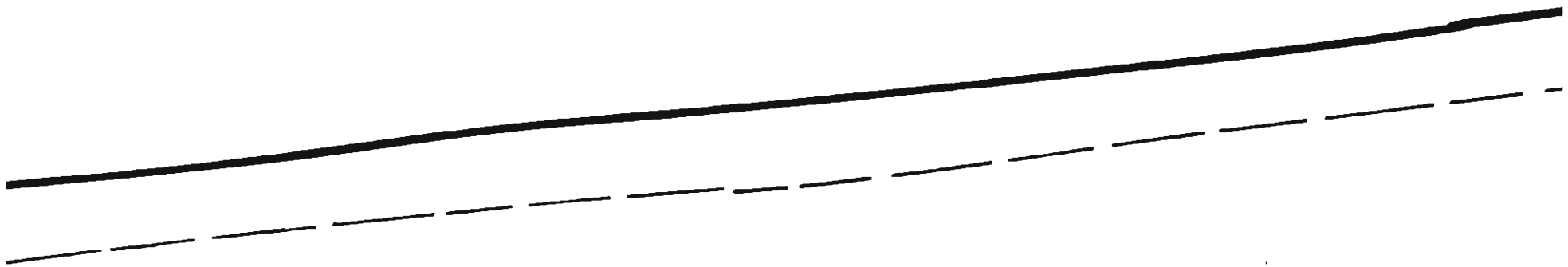

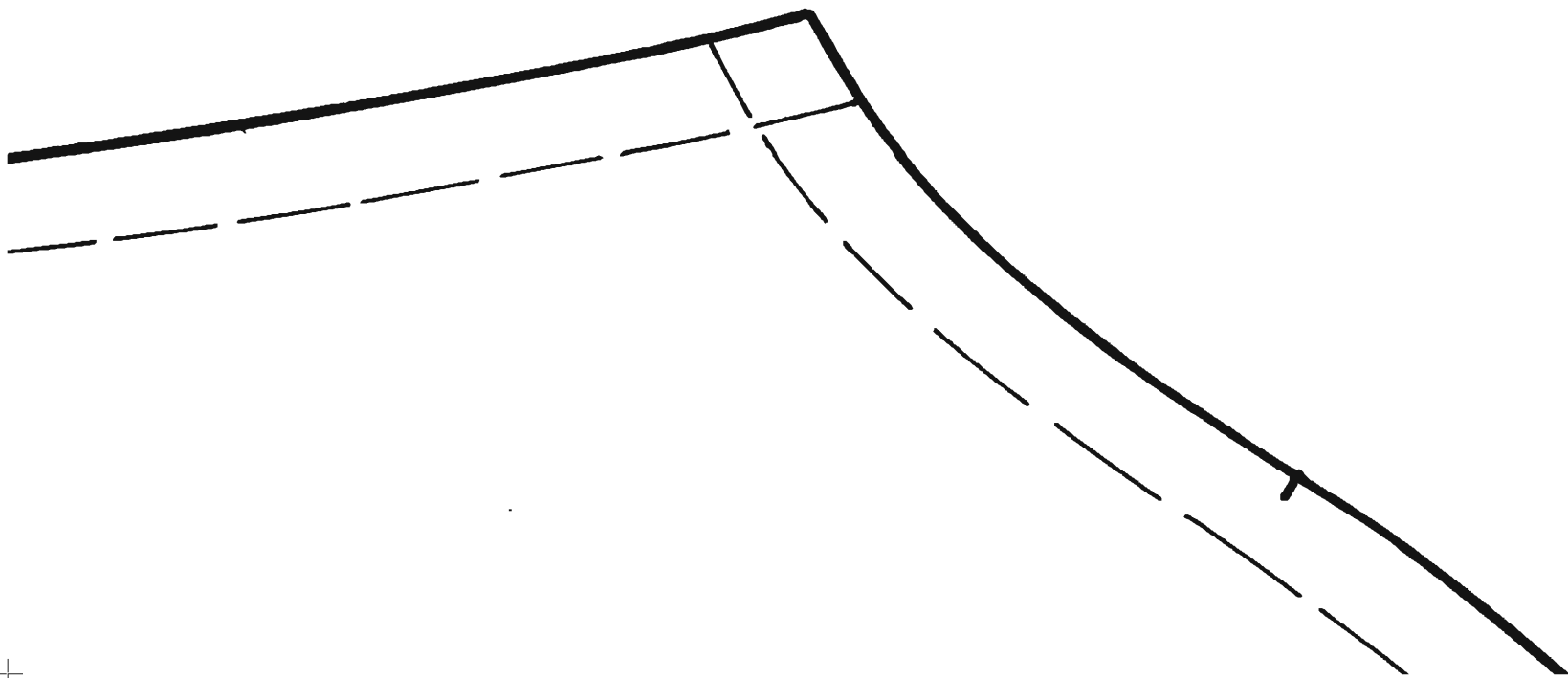

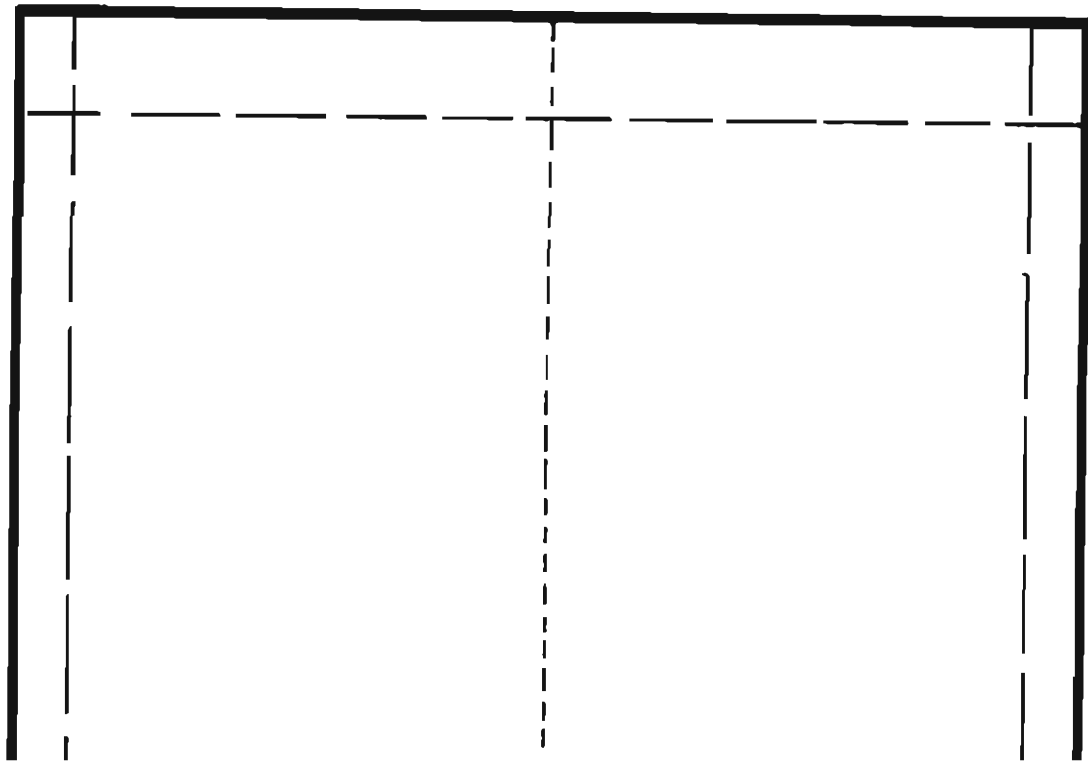

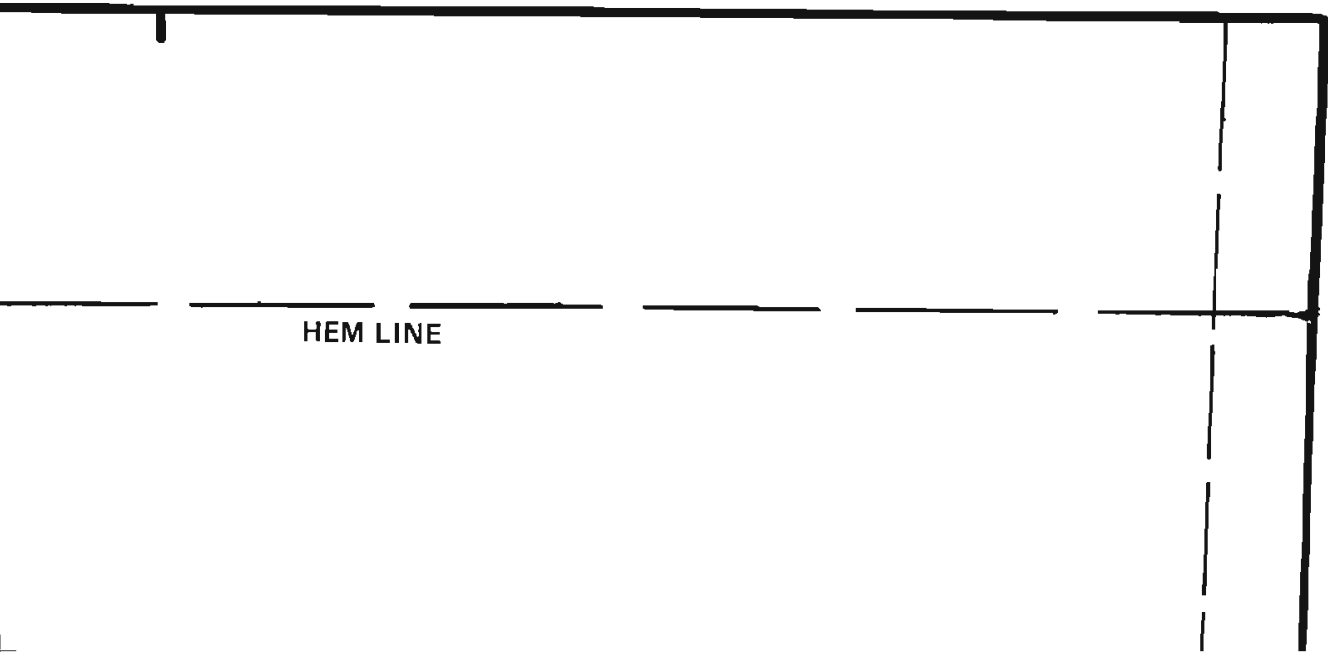

HEM LINE



**Sleeve
Cut 2**

ONE RIGHT AND ONE LEFT

Size 38

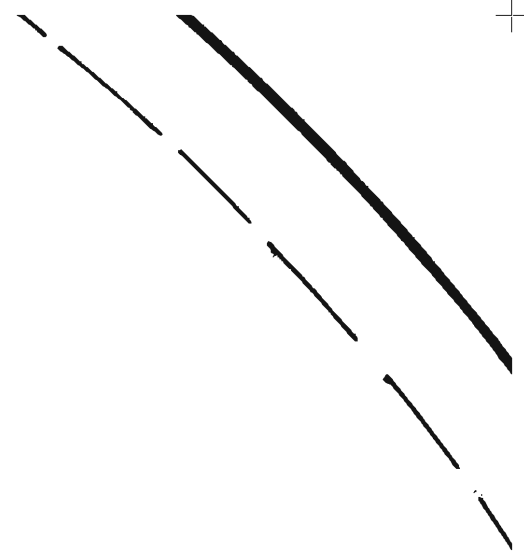



**Belt
Cut 1**



Lo

**wer Center Back
Cut 2**

ONE RIGHT AND ONE LEFT

Size 38

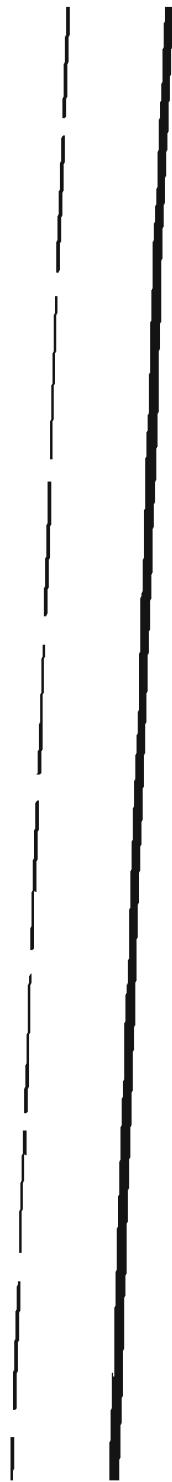

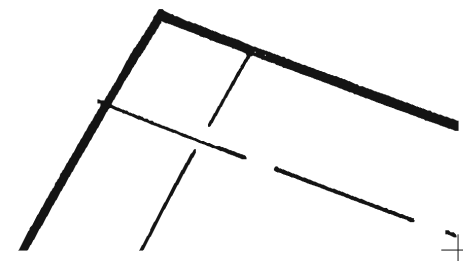
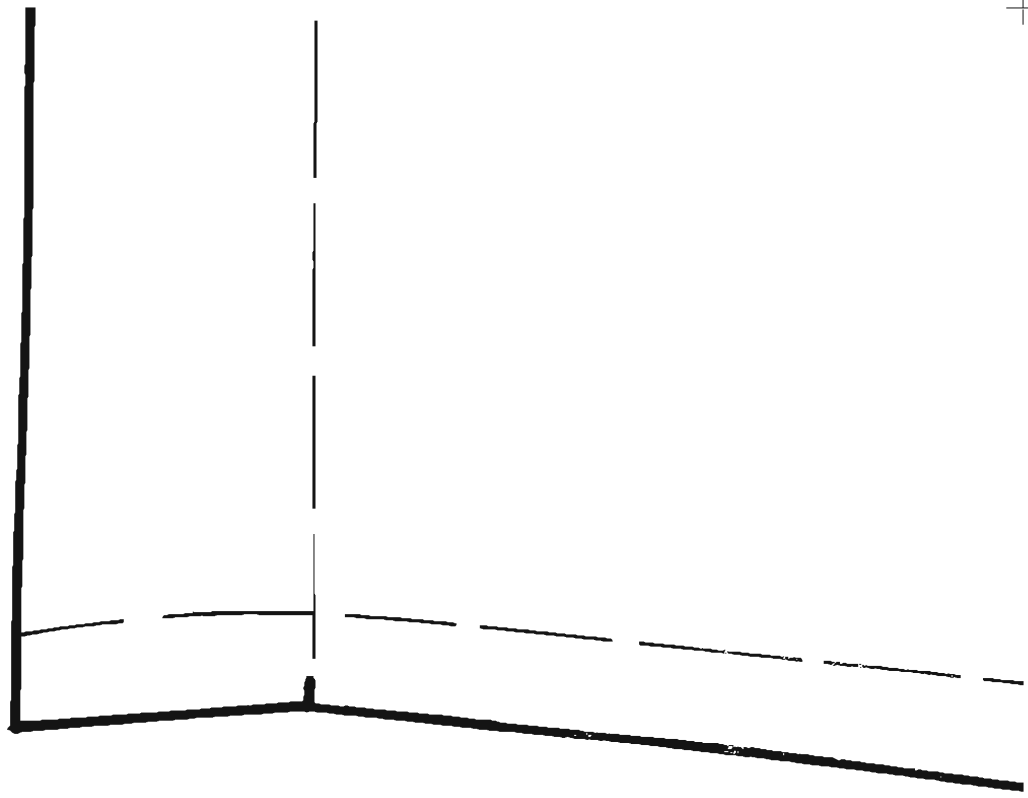



Line

e

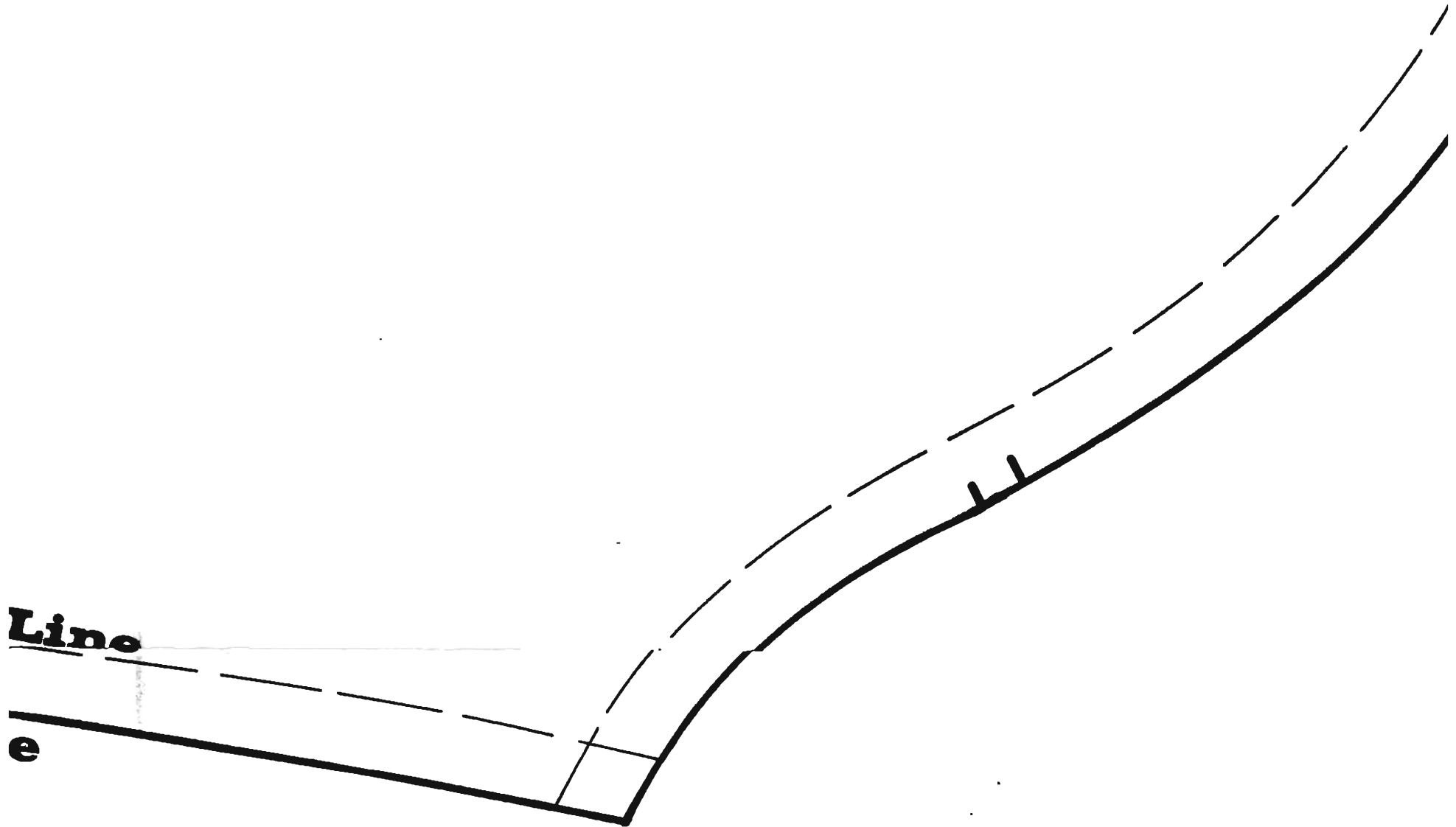

Men's Top Coat

Cut Line

Stitch Line

Size

38

Fold Line



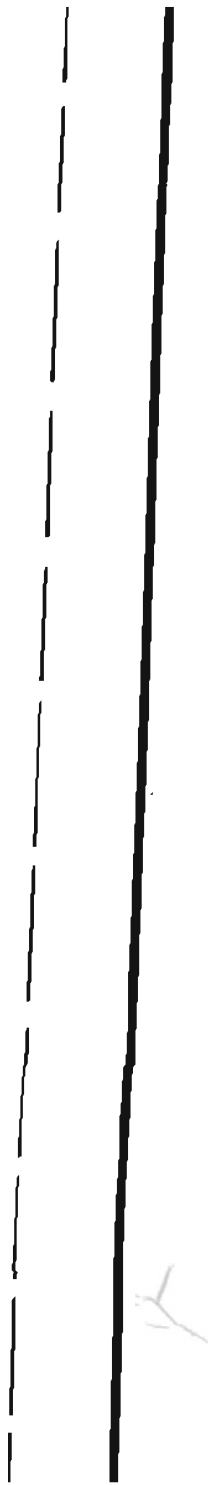

Y

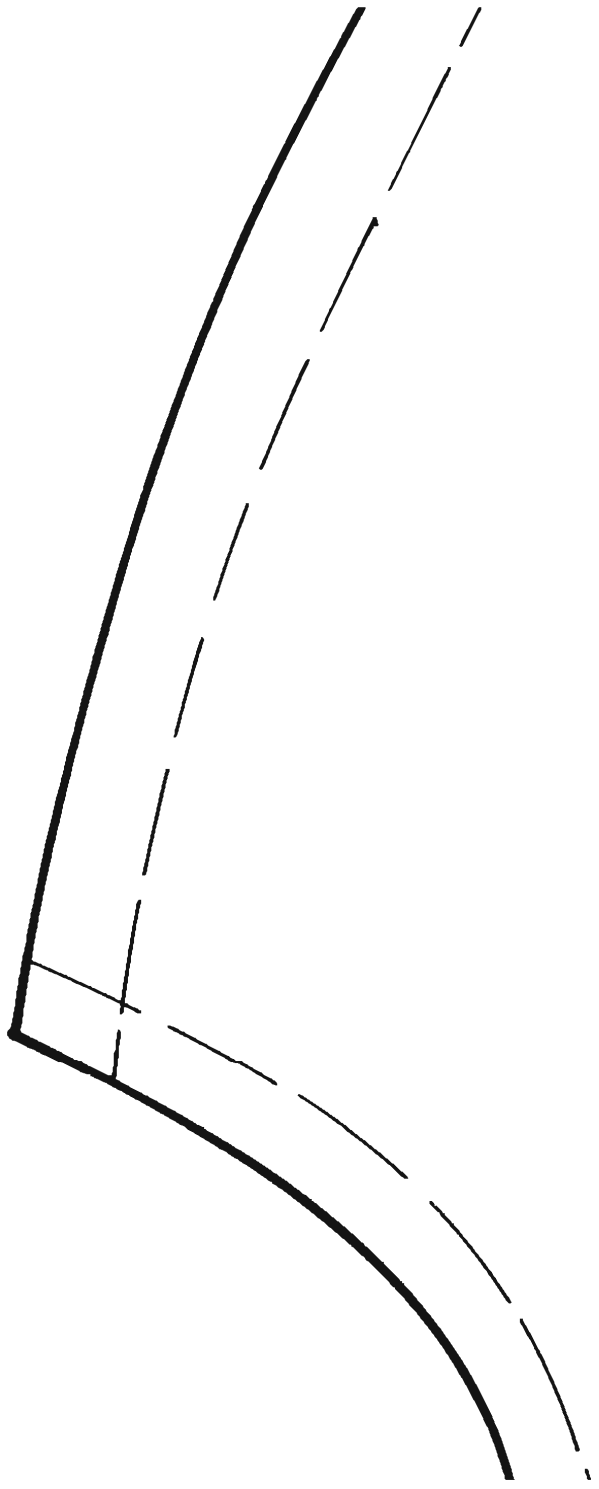

Stitch Line

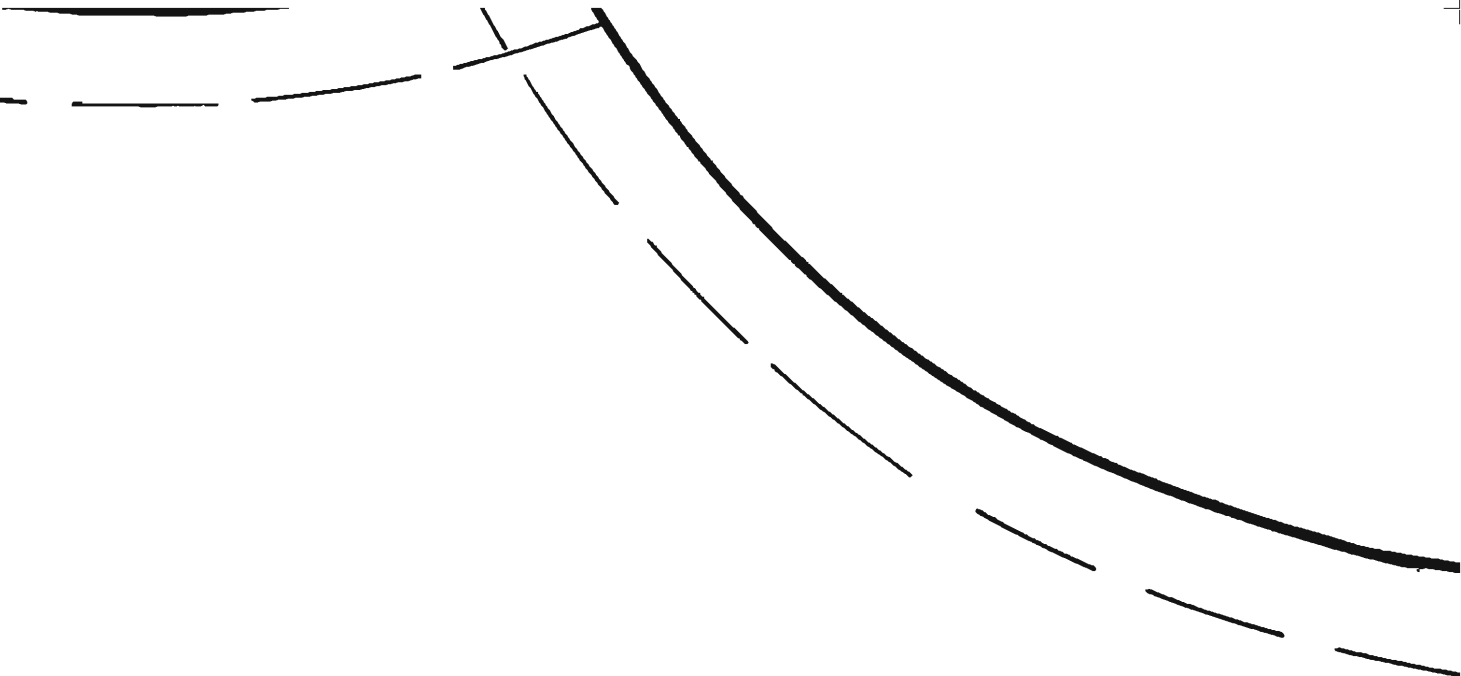

Pattern Pieces

Size 38

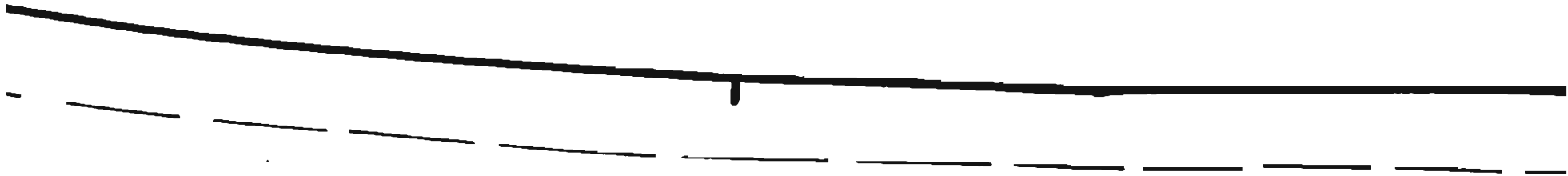

**Center Front
Cut 2**

ONE RIGHT AND ONE LEFT

Size 38

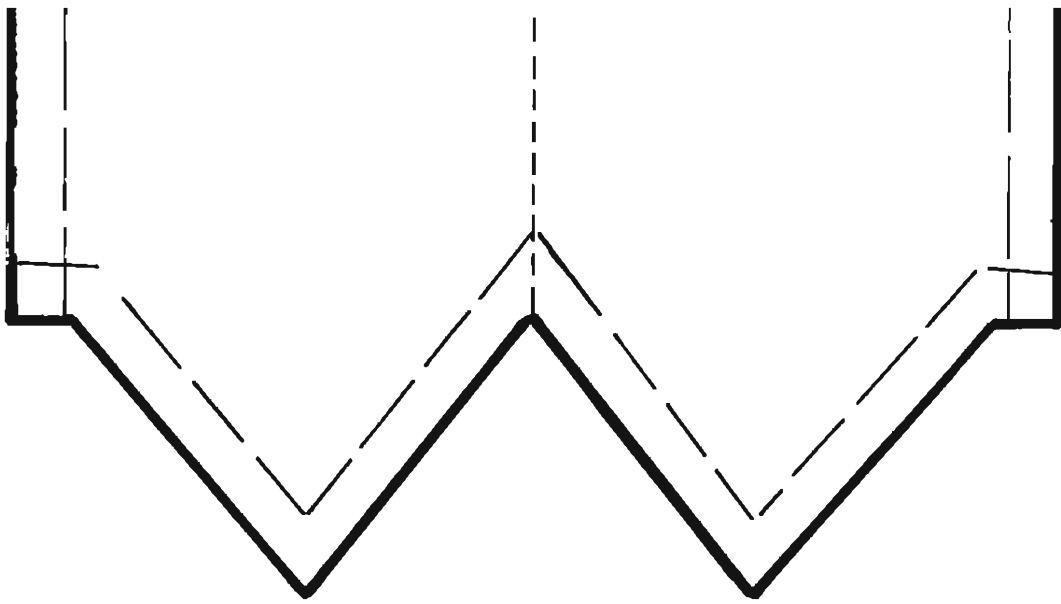

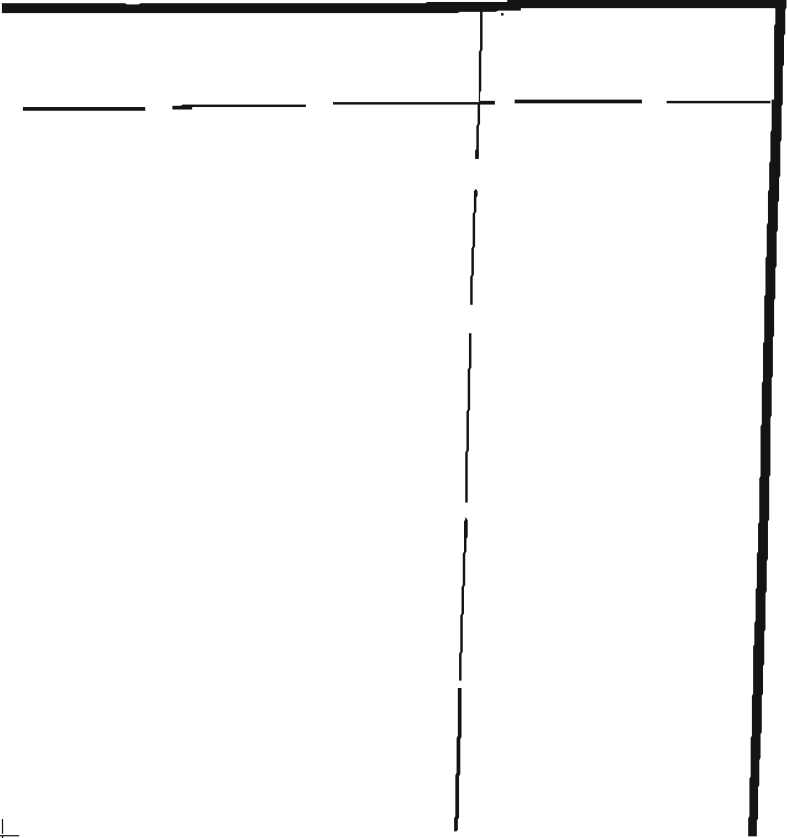
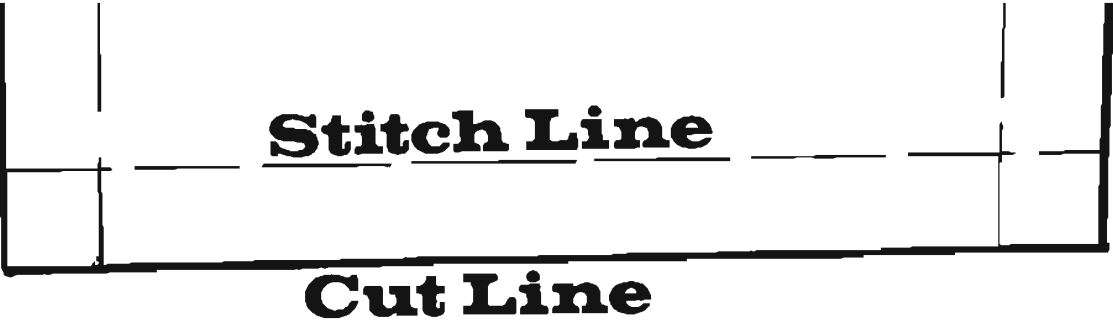

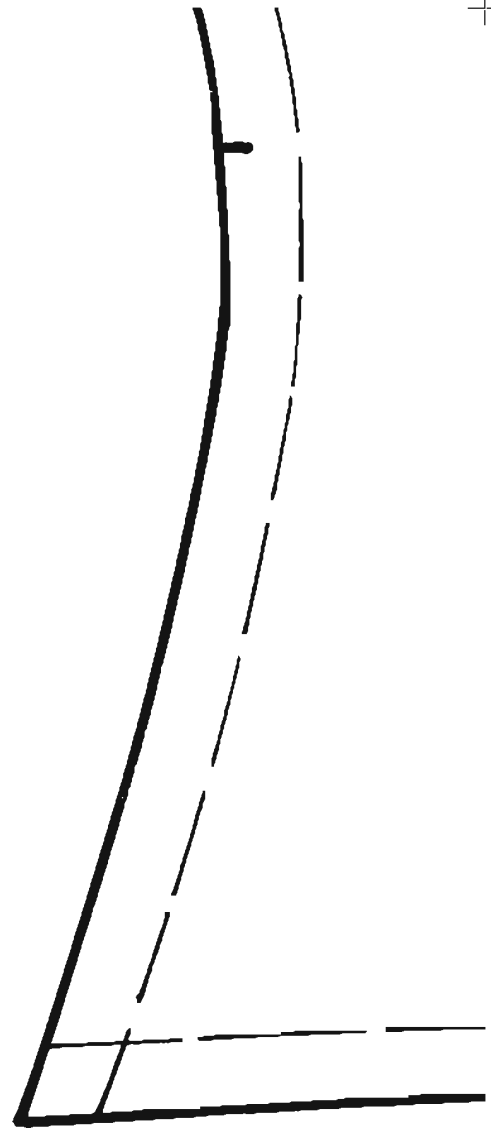

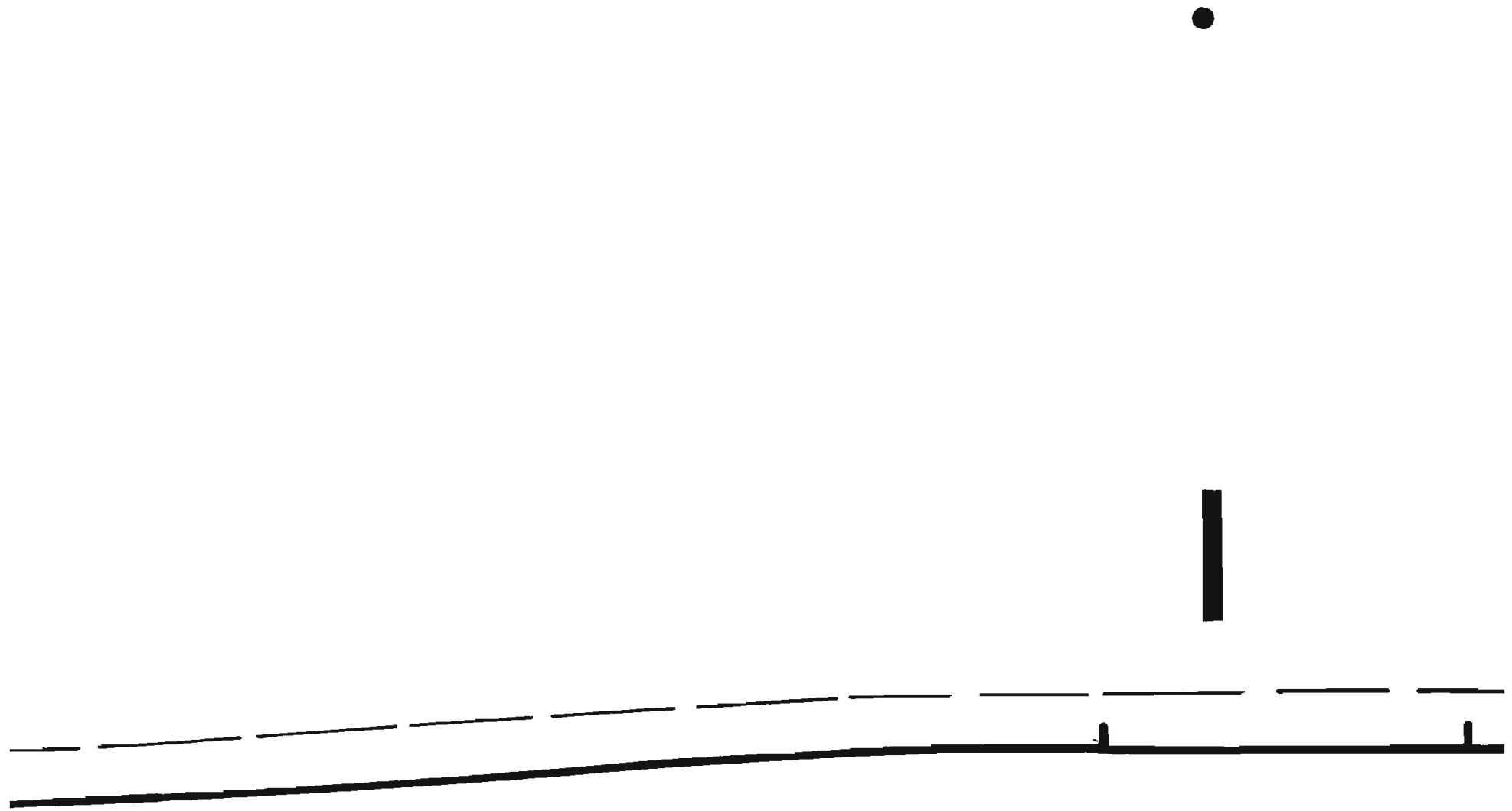

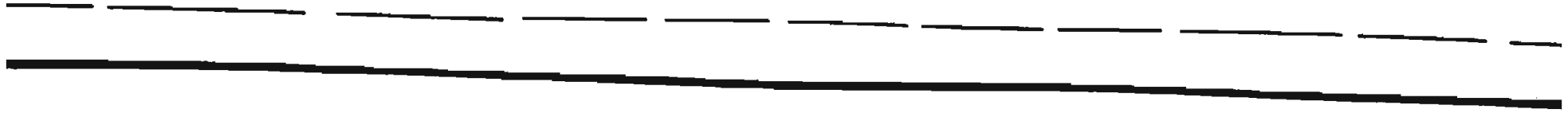

 **BUTTON LOCATION**

 **BUTTONHOLE LOCATION**



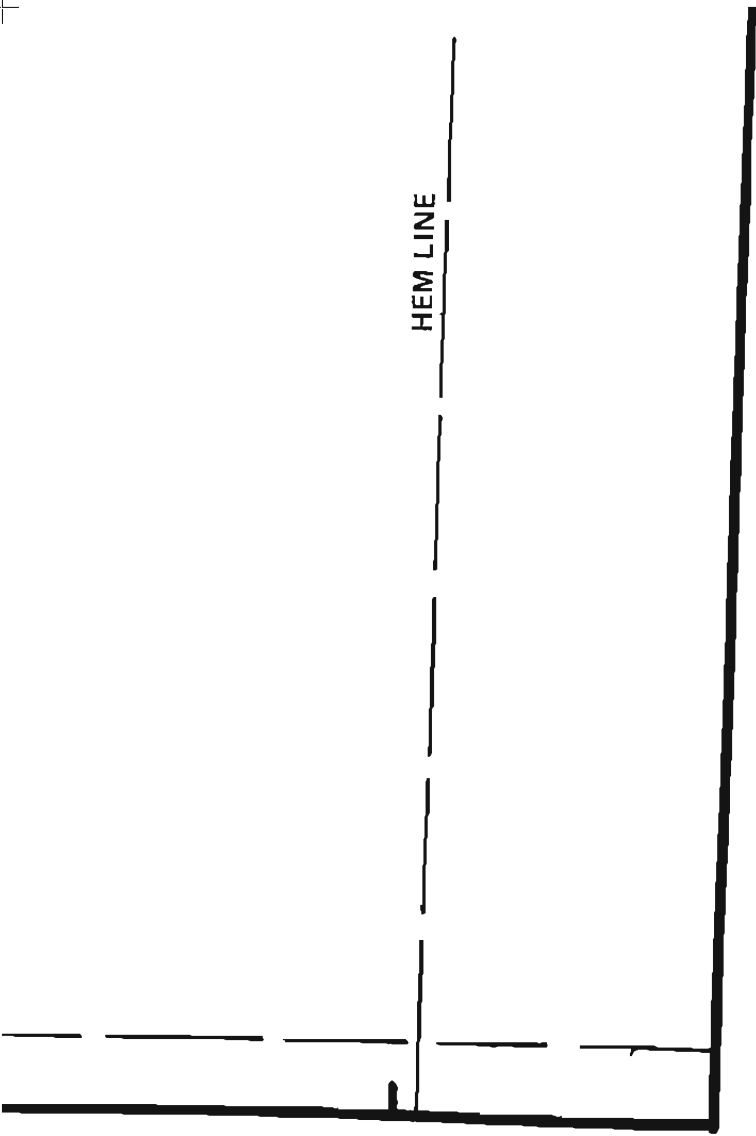

**Men's Top Coat
Pattern Pieces
Size 38**

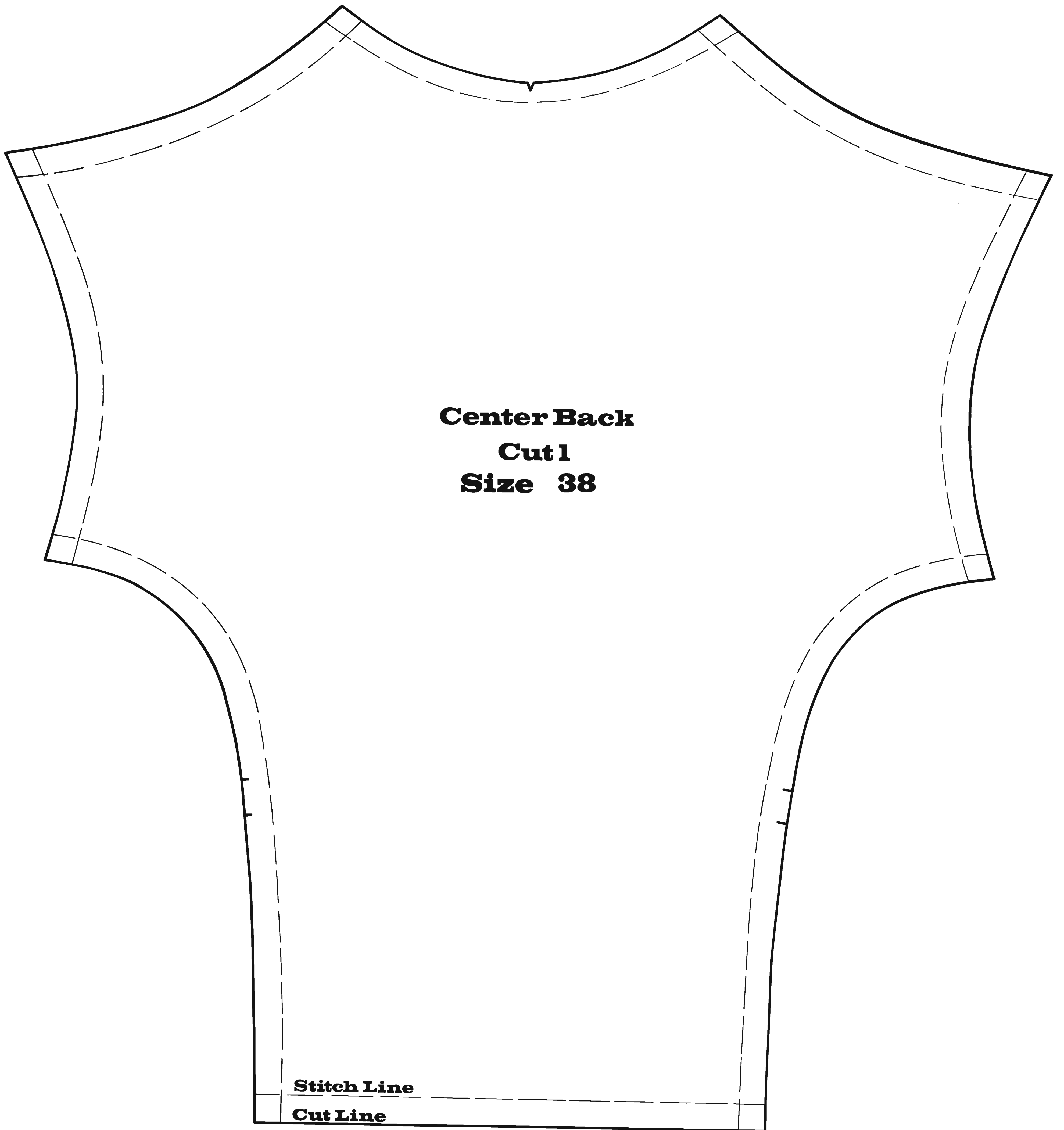

Men's Top Coat Pattern Pieces

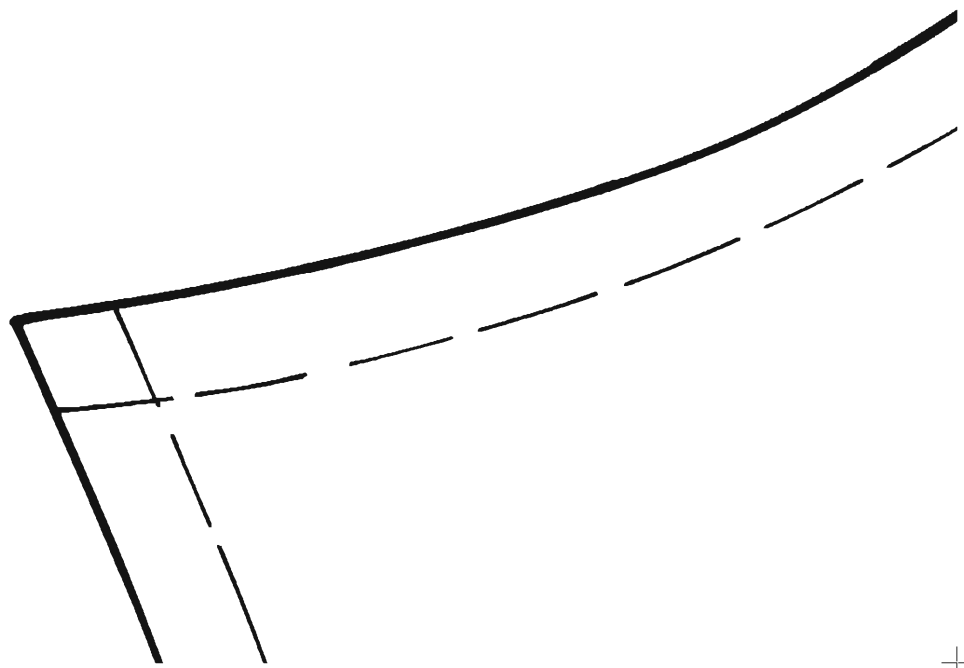

Size 38



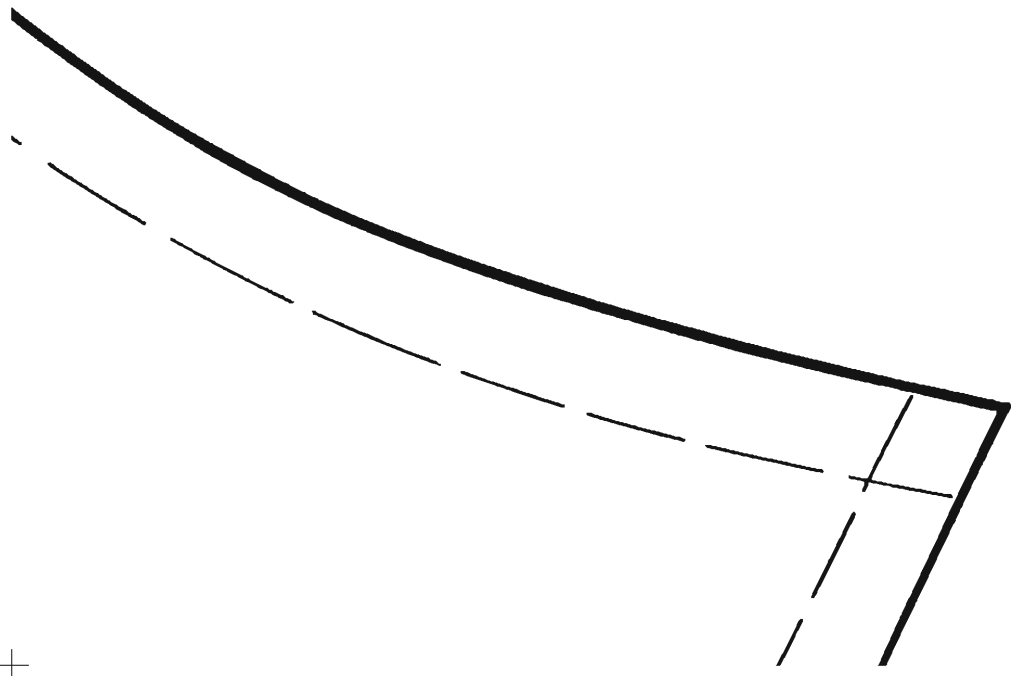

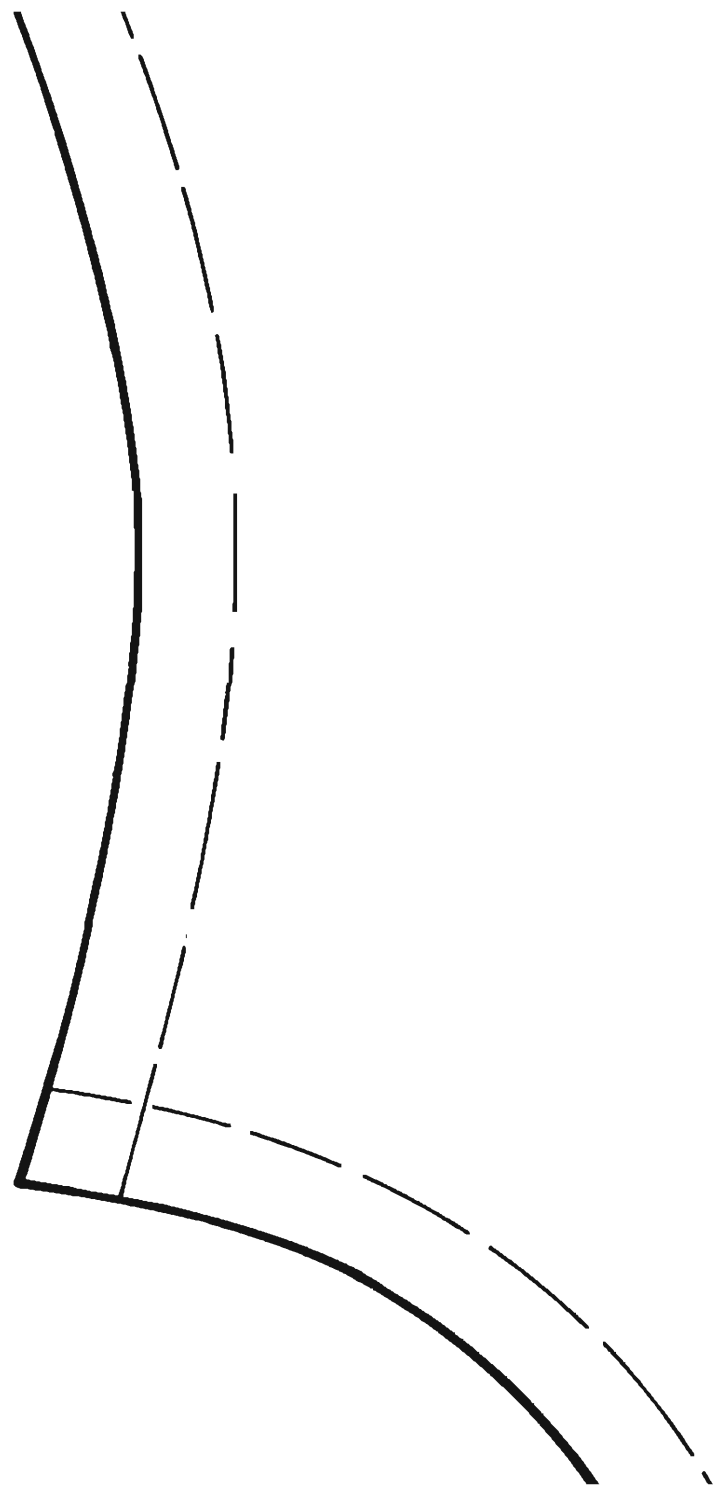

Center Back

Cut 1

Size 38

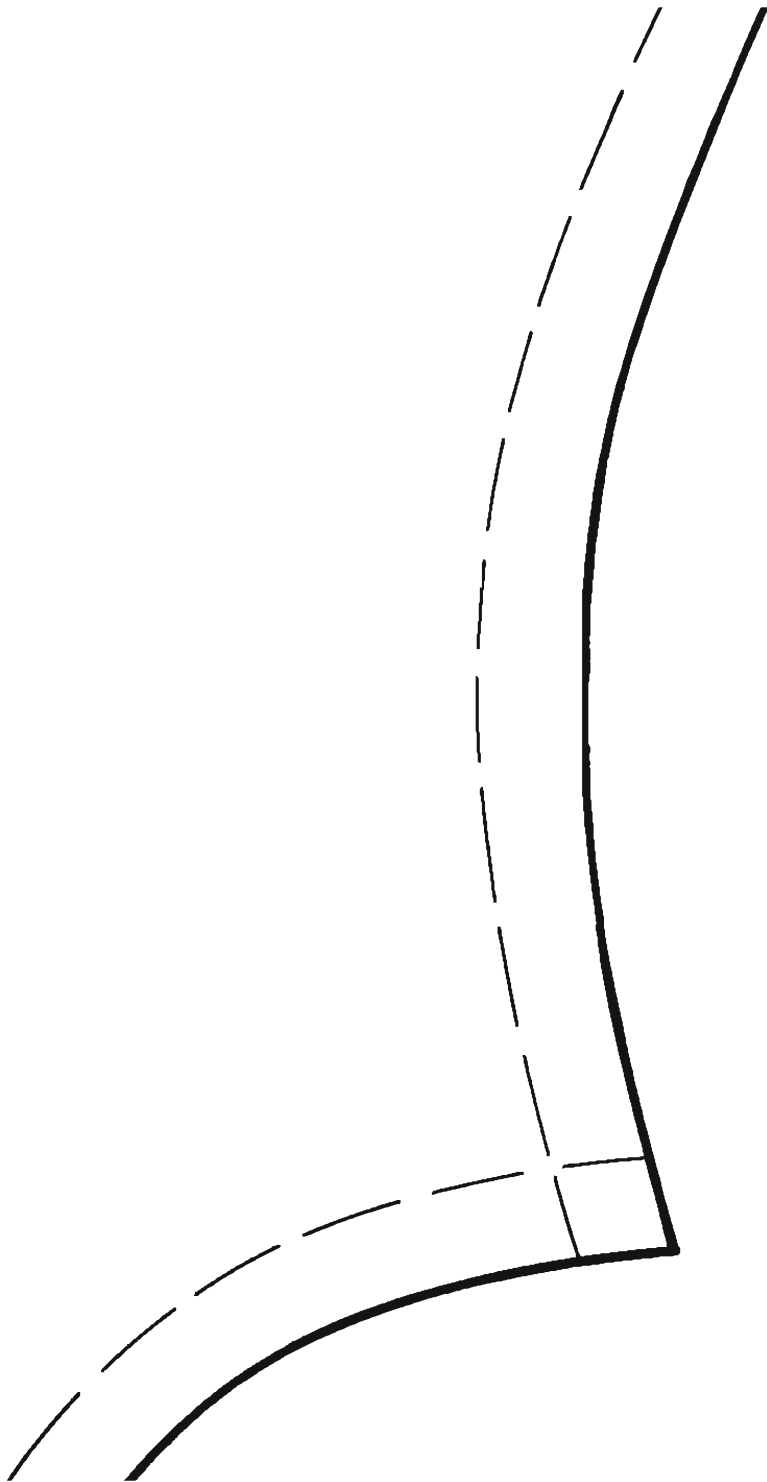

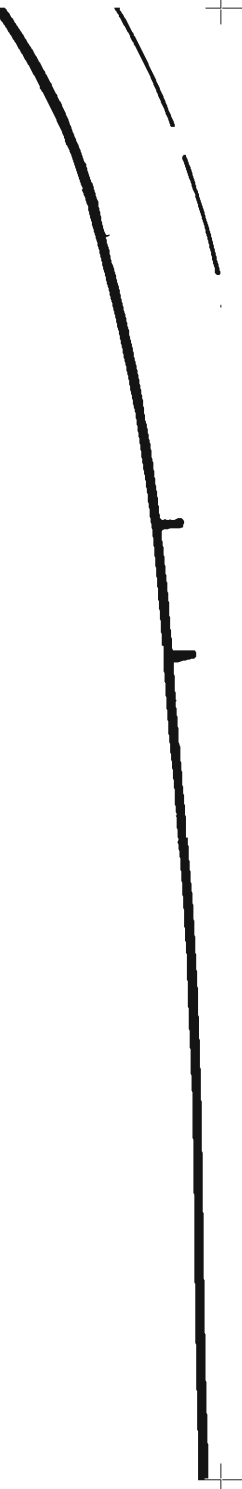







Stitch Line

Cut Line





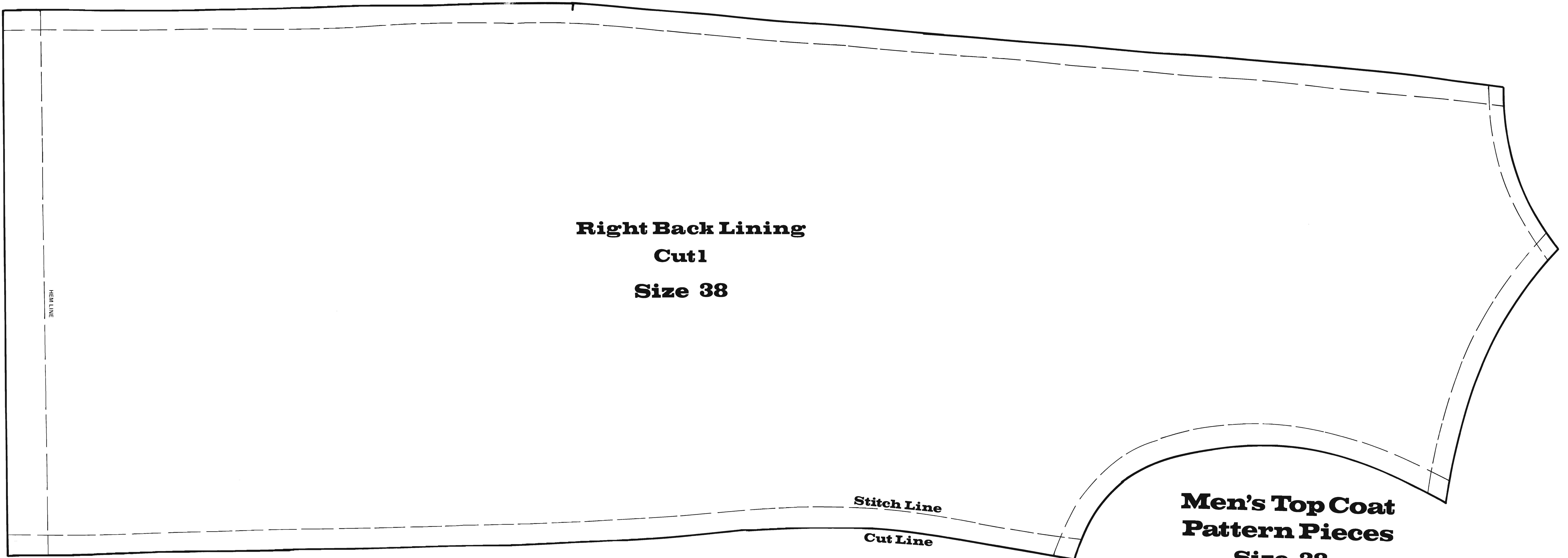

Men's Top Coat
Pattern Pieces
Size 38

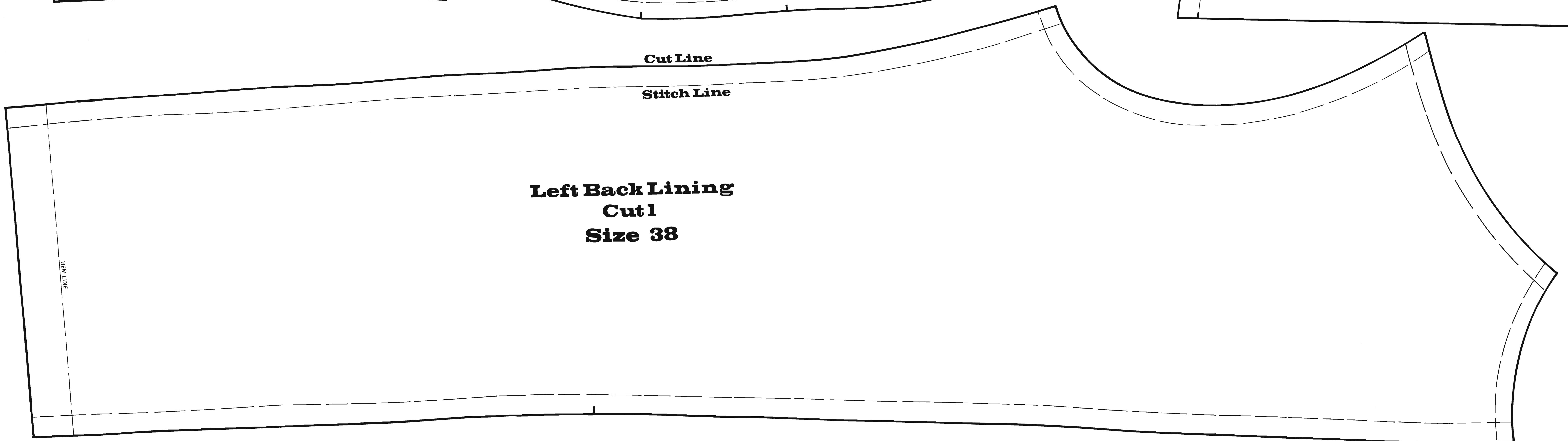
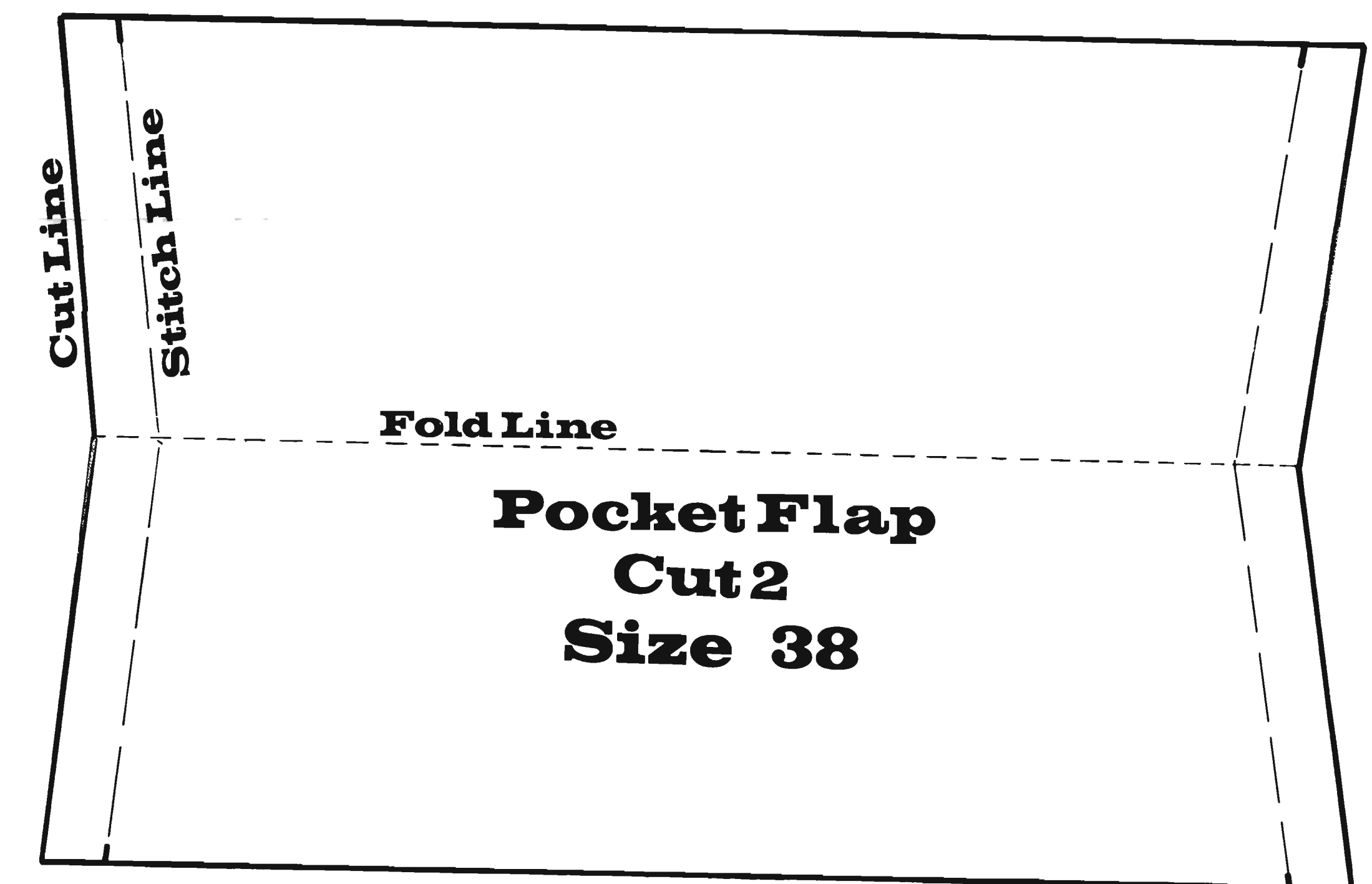
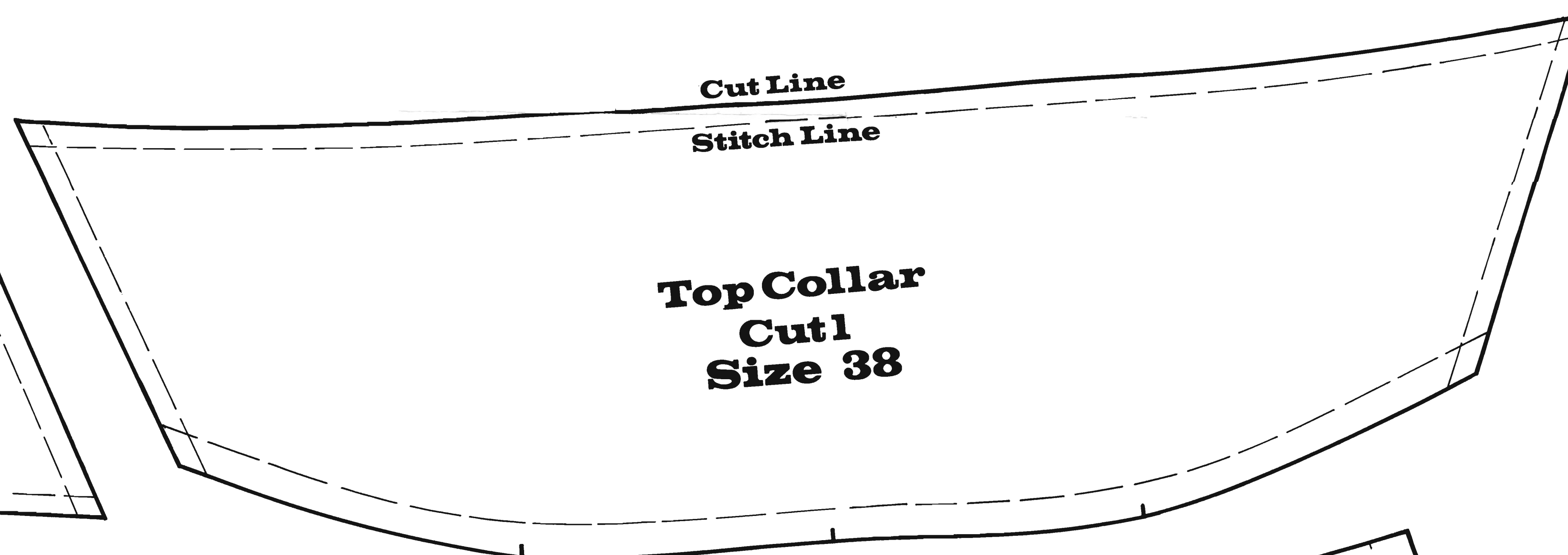
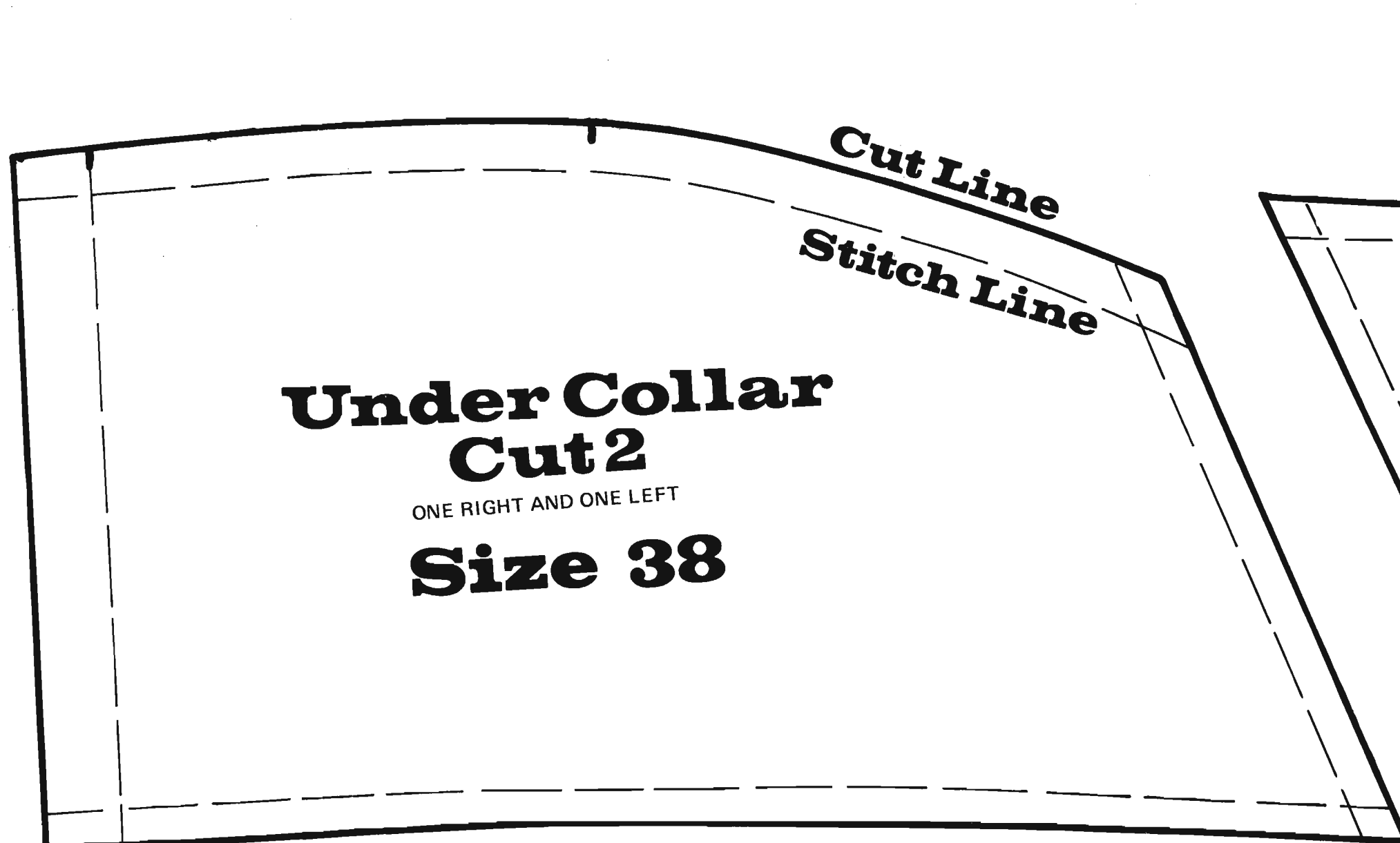

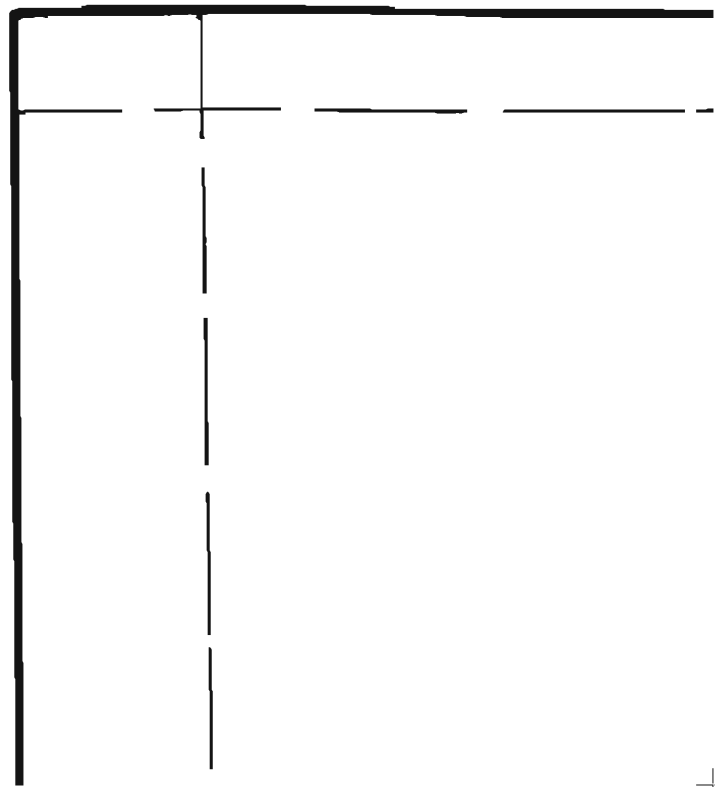

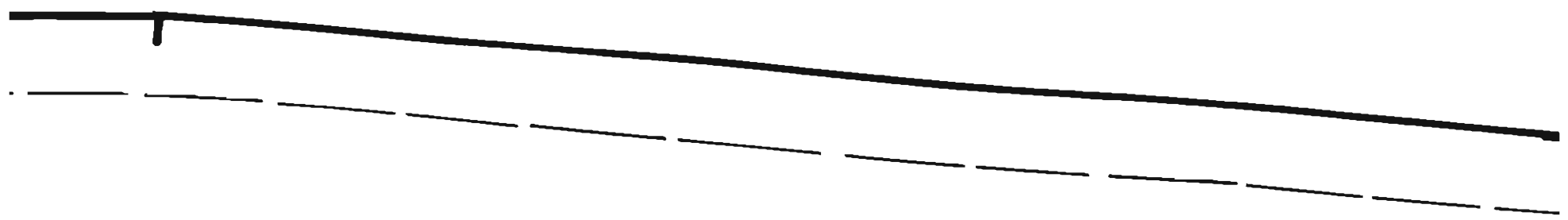





HEM LINE



Right Back Lining

Cut1

Size 38

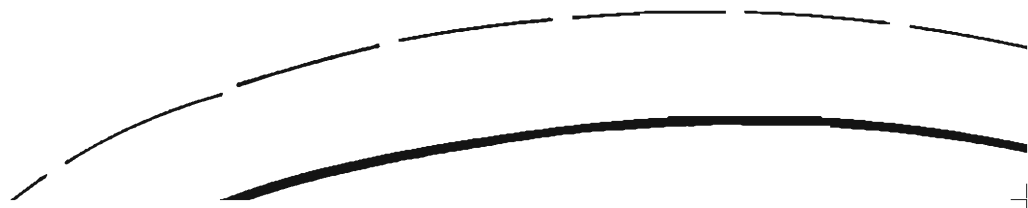

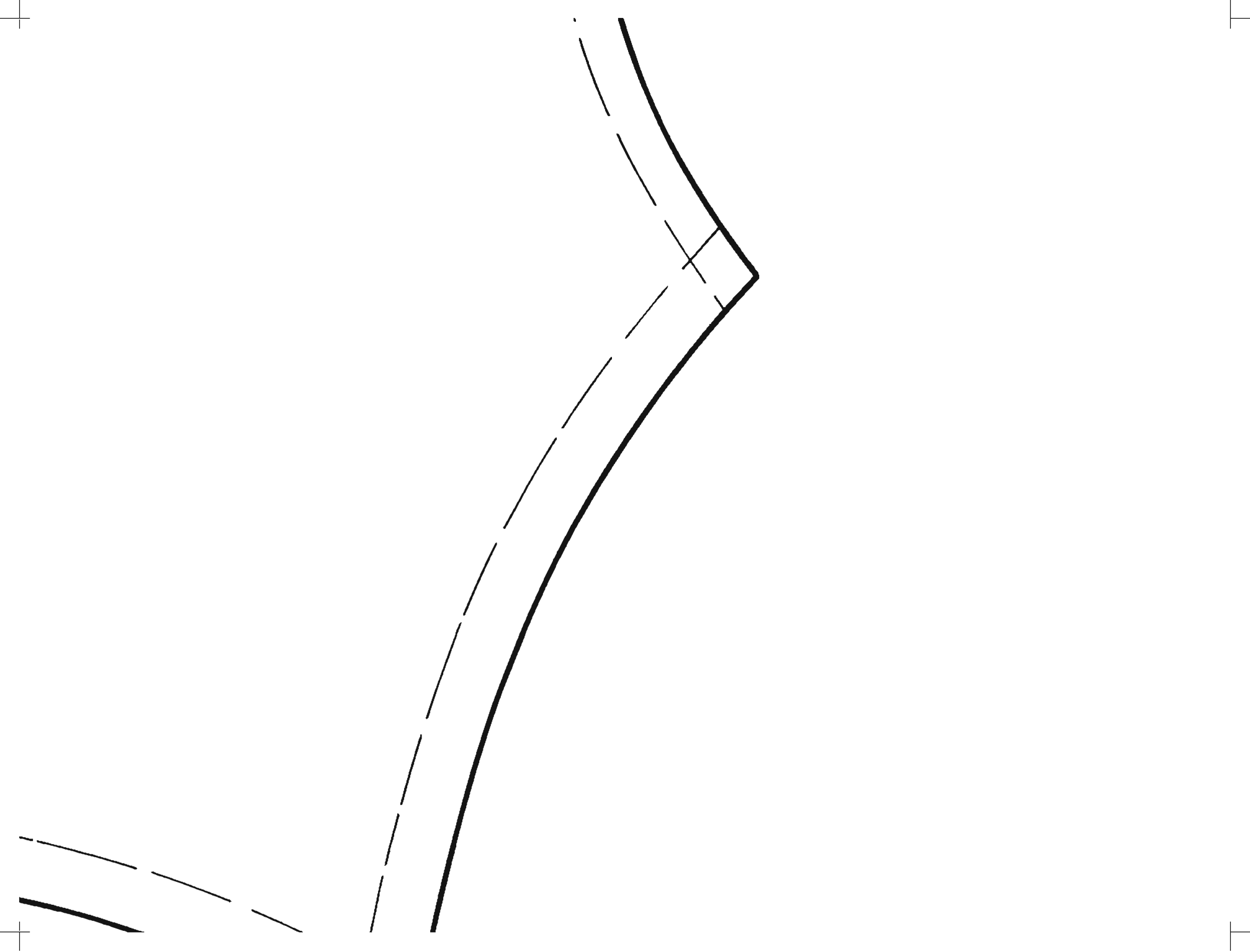

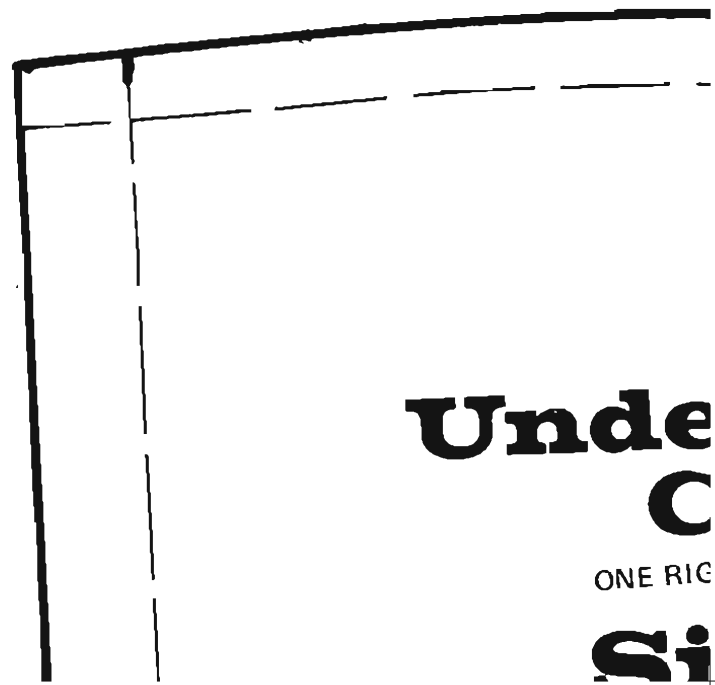
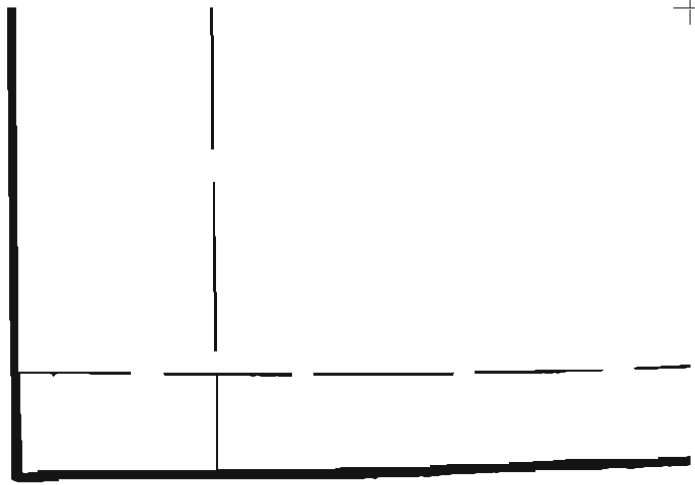

Unde
C
ONE RIC
Si

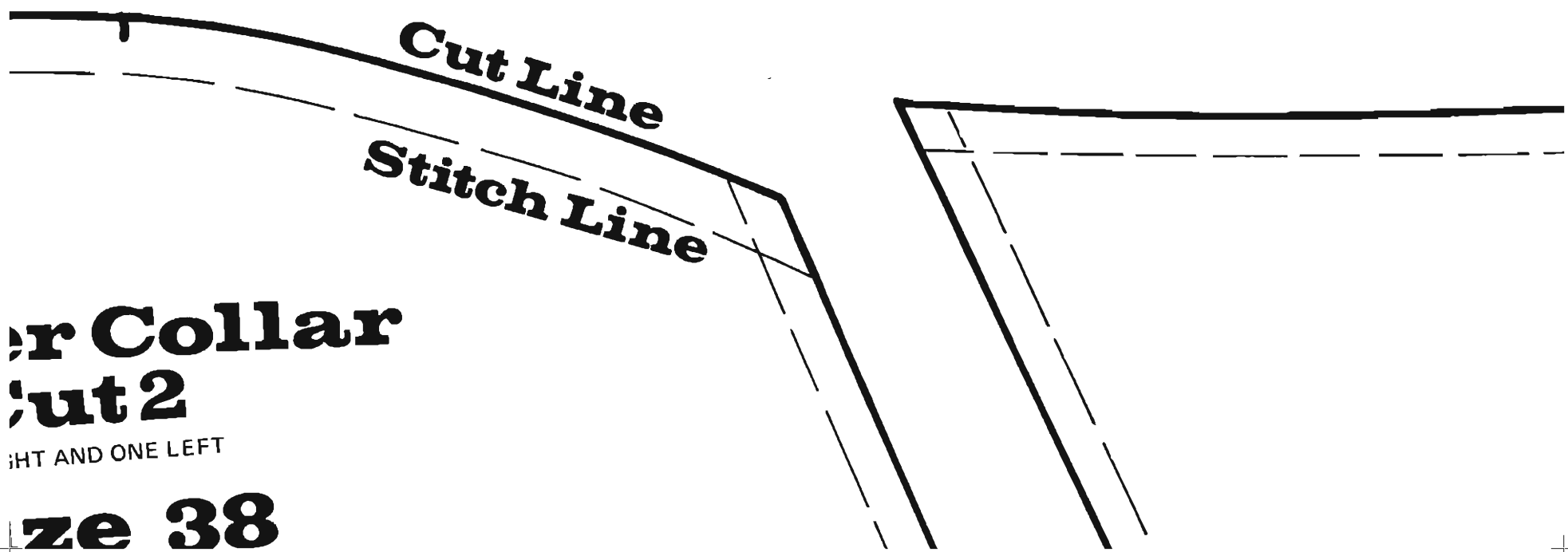
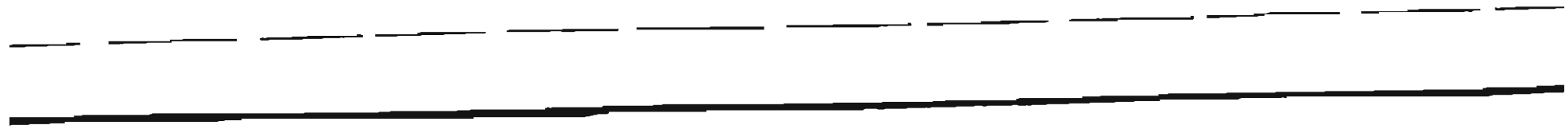

Cut Line

Stitch Line

er Collar
ut 2

IGHT AND ONE LEFT

ze 38

Stitch Line

Cut Line

Cut Line

Stitch Line

Top Collar

Cutl

00

Men's Top Pattern P Size 38

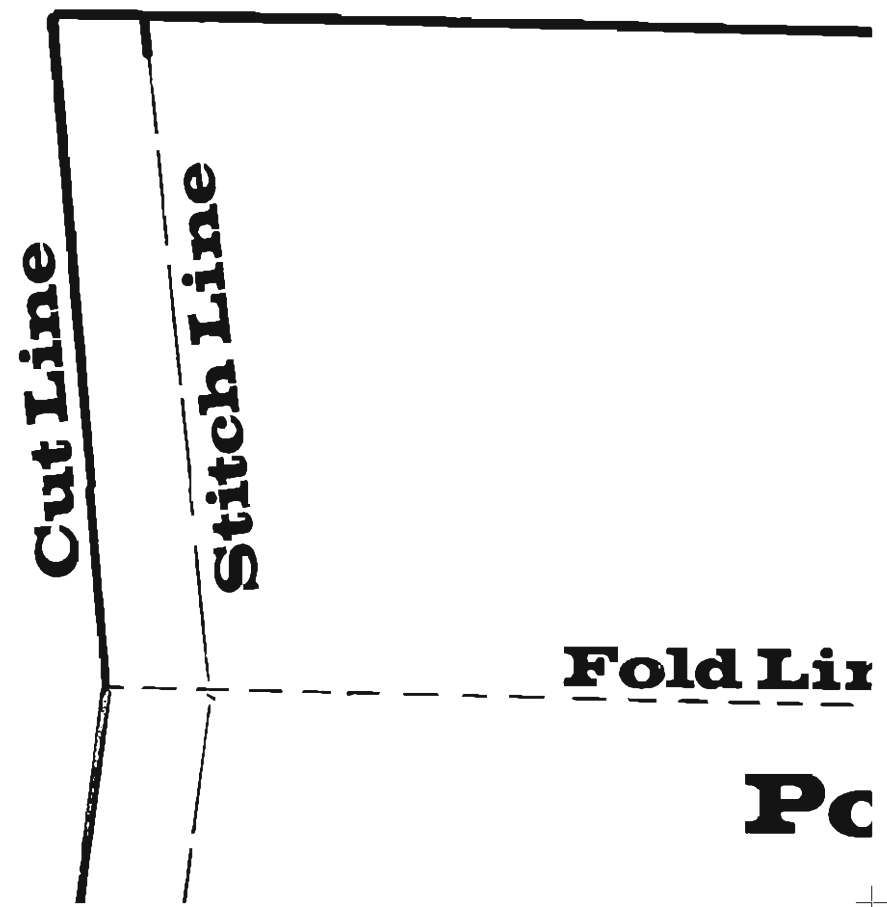
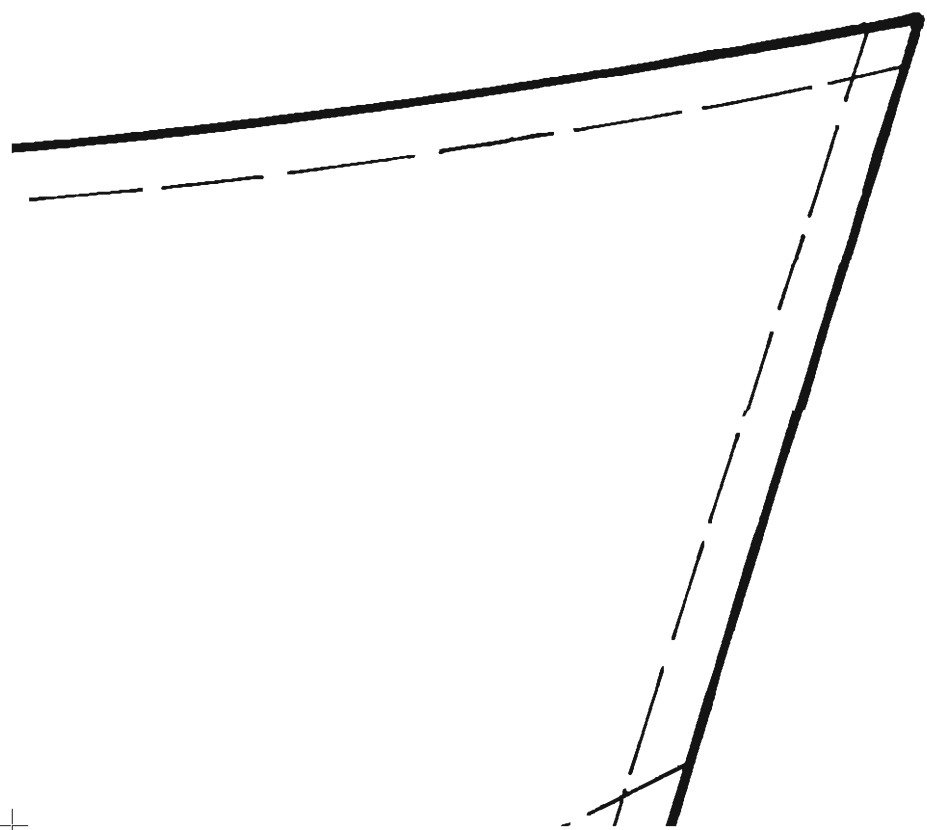
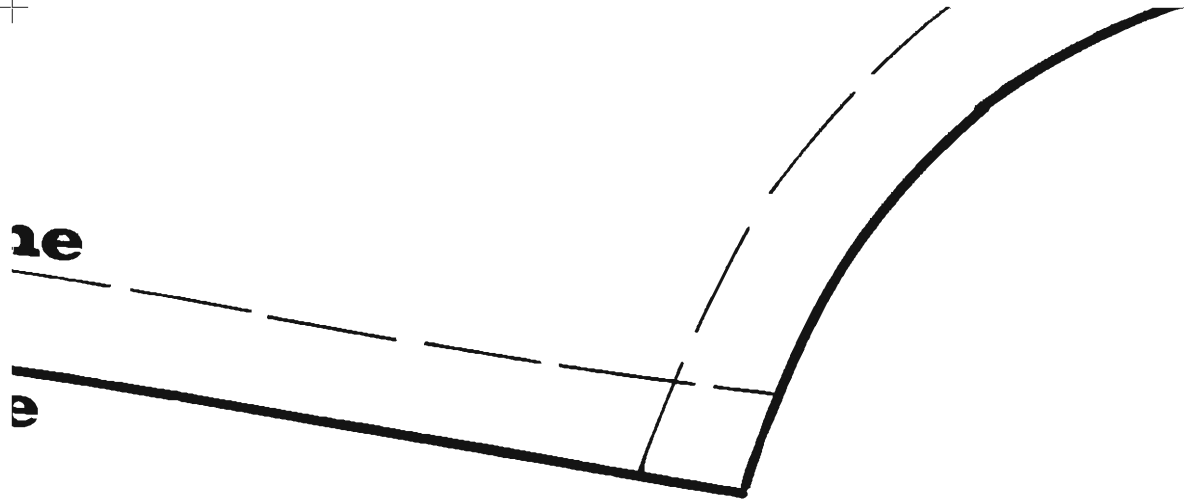

**Coat
pieces**

3

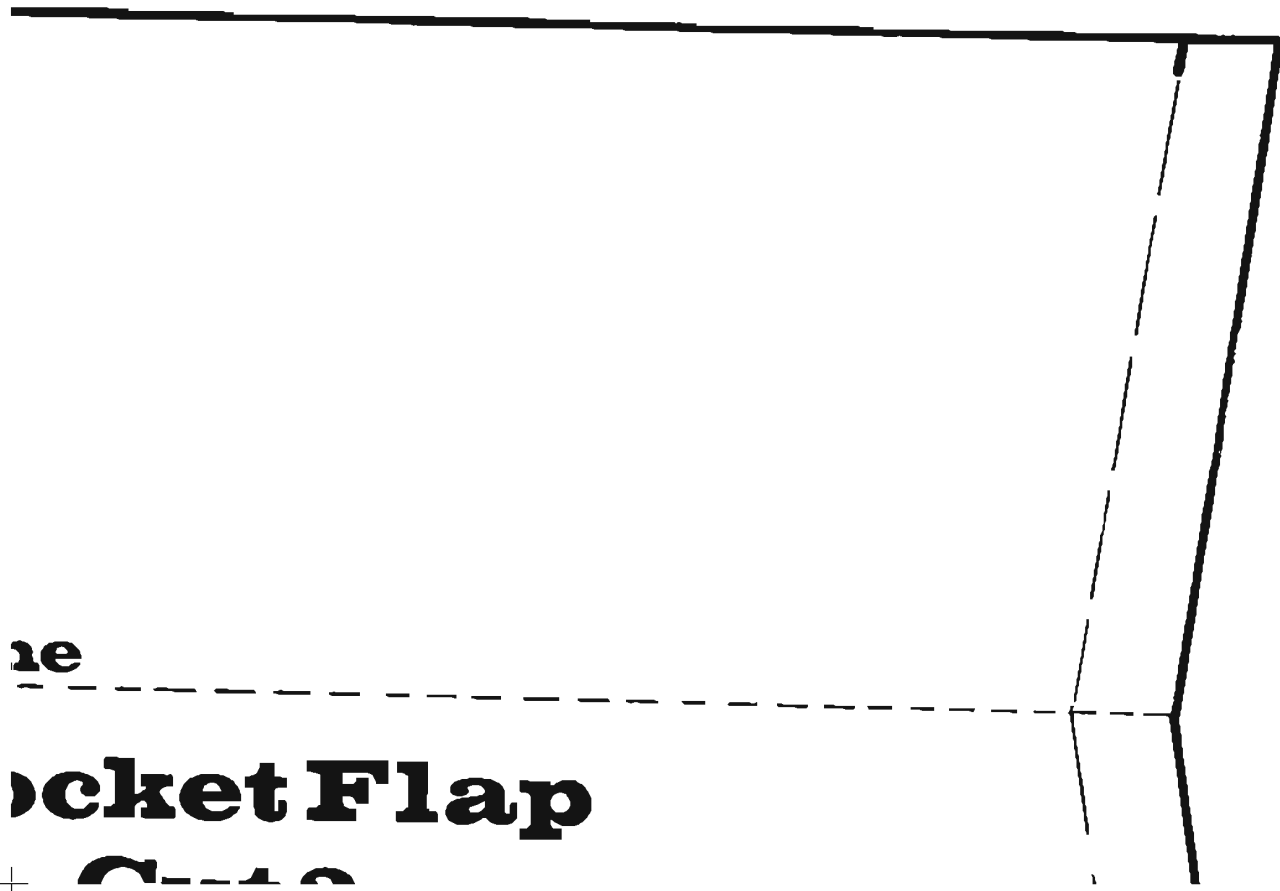

re

Pocket Flap

Auto

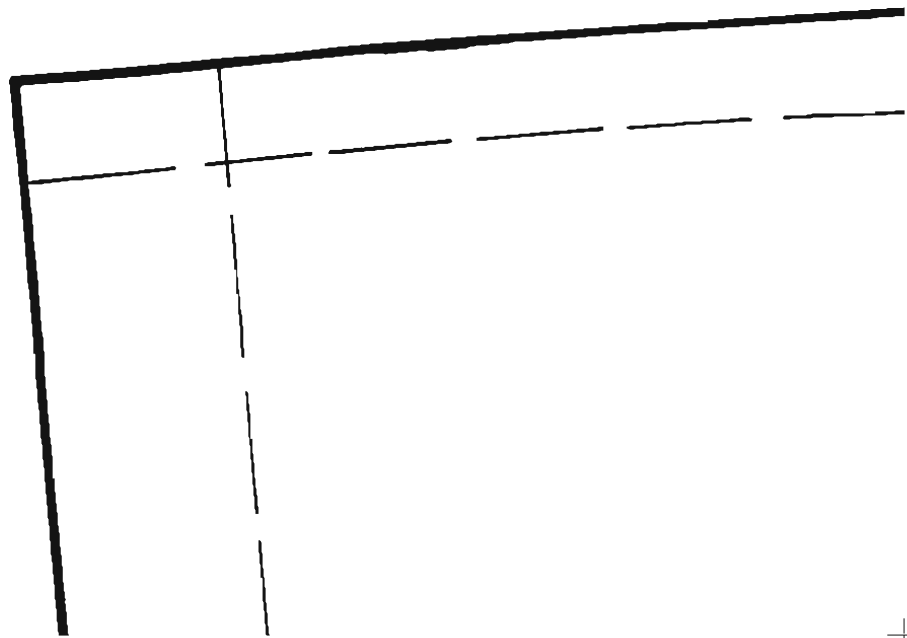

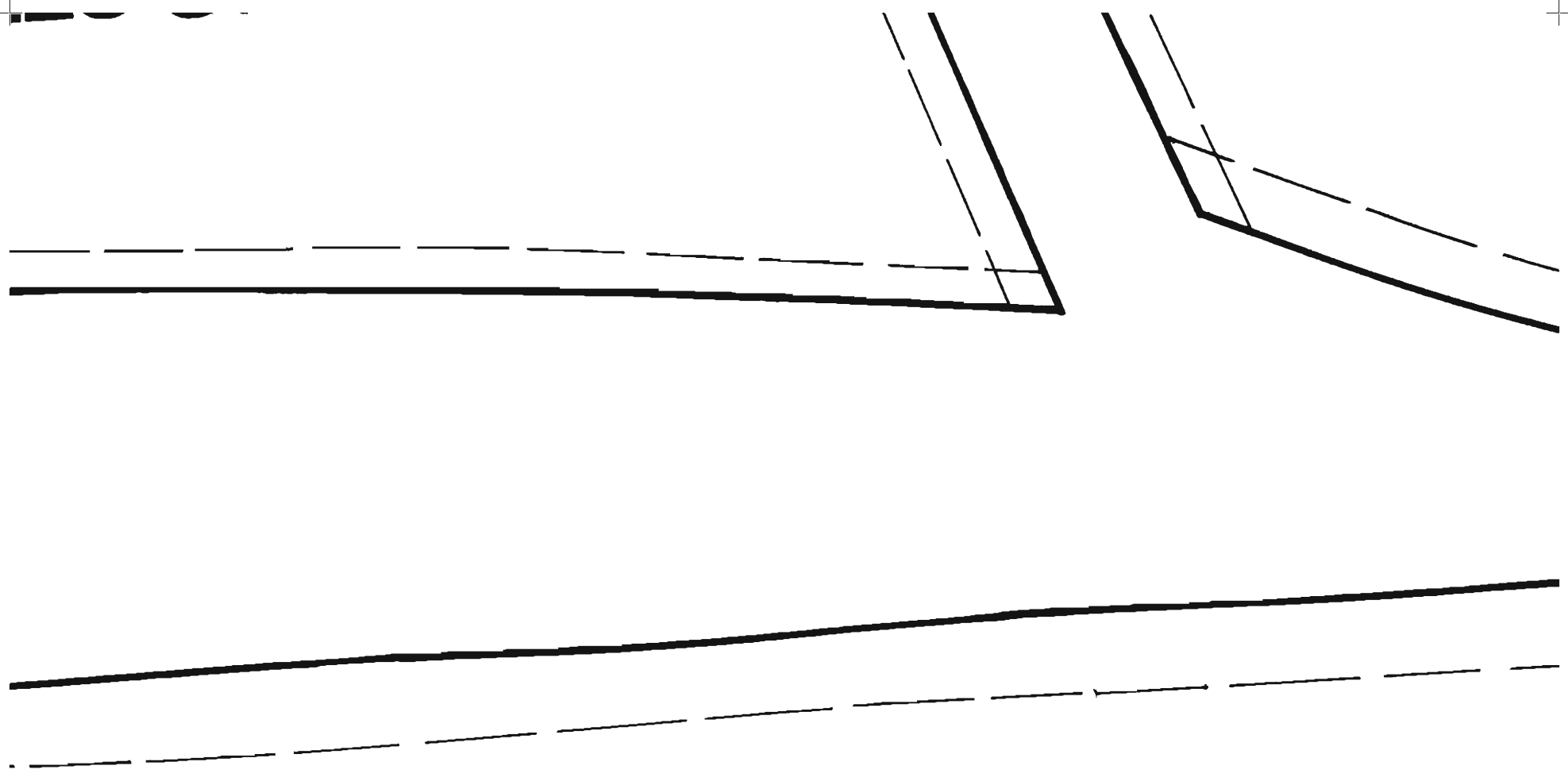

Lef

Size 38



Cut Line



Stitch Line

t Back Lining
Cut 1

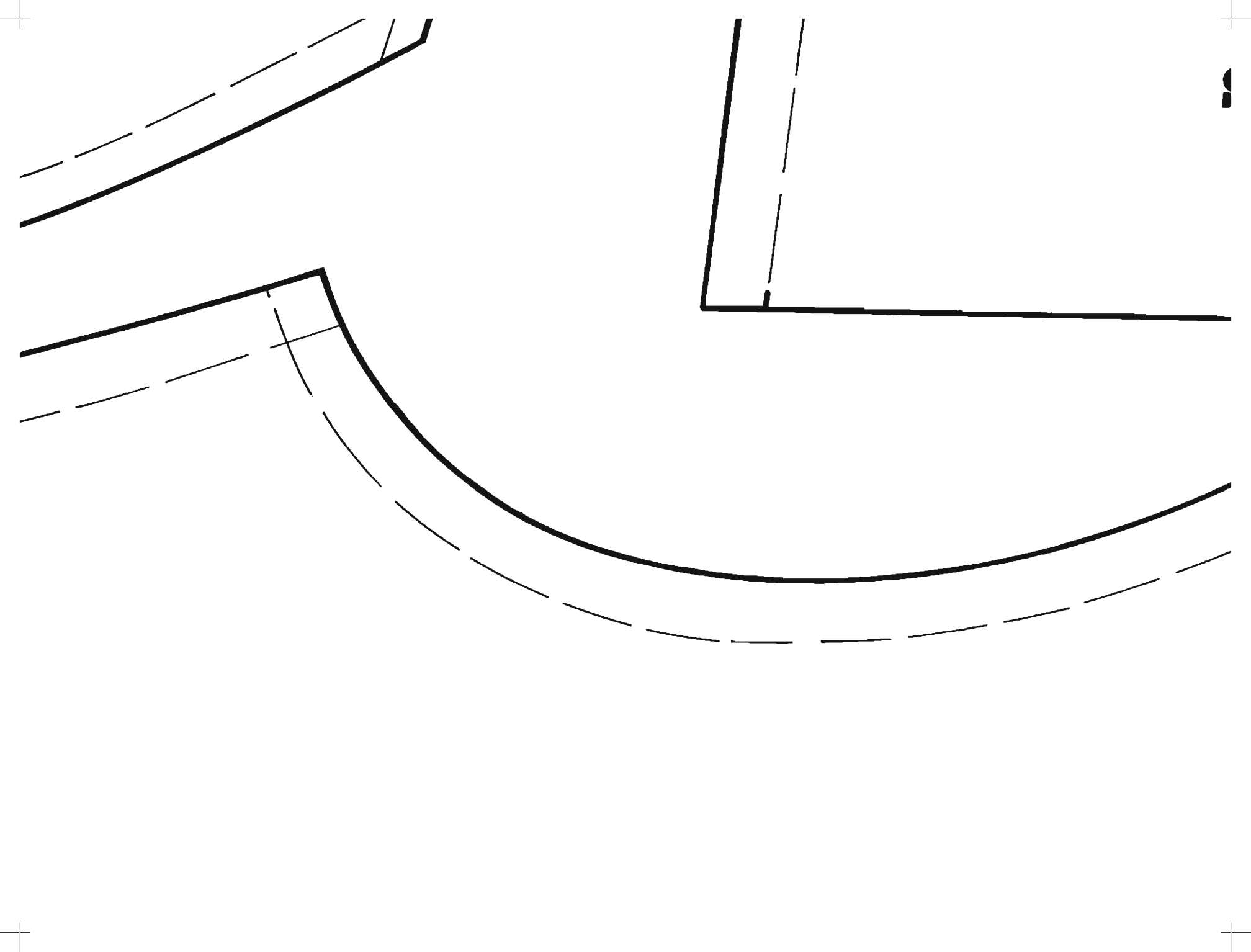

Cut 2
Size 38

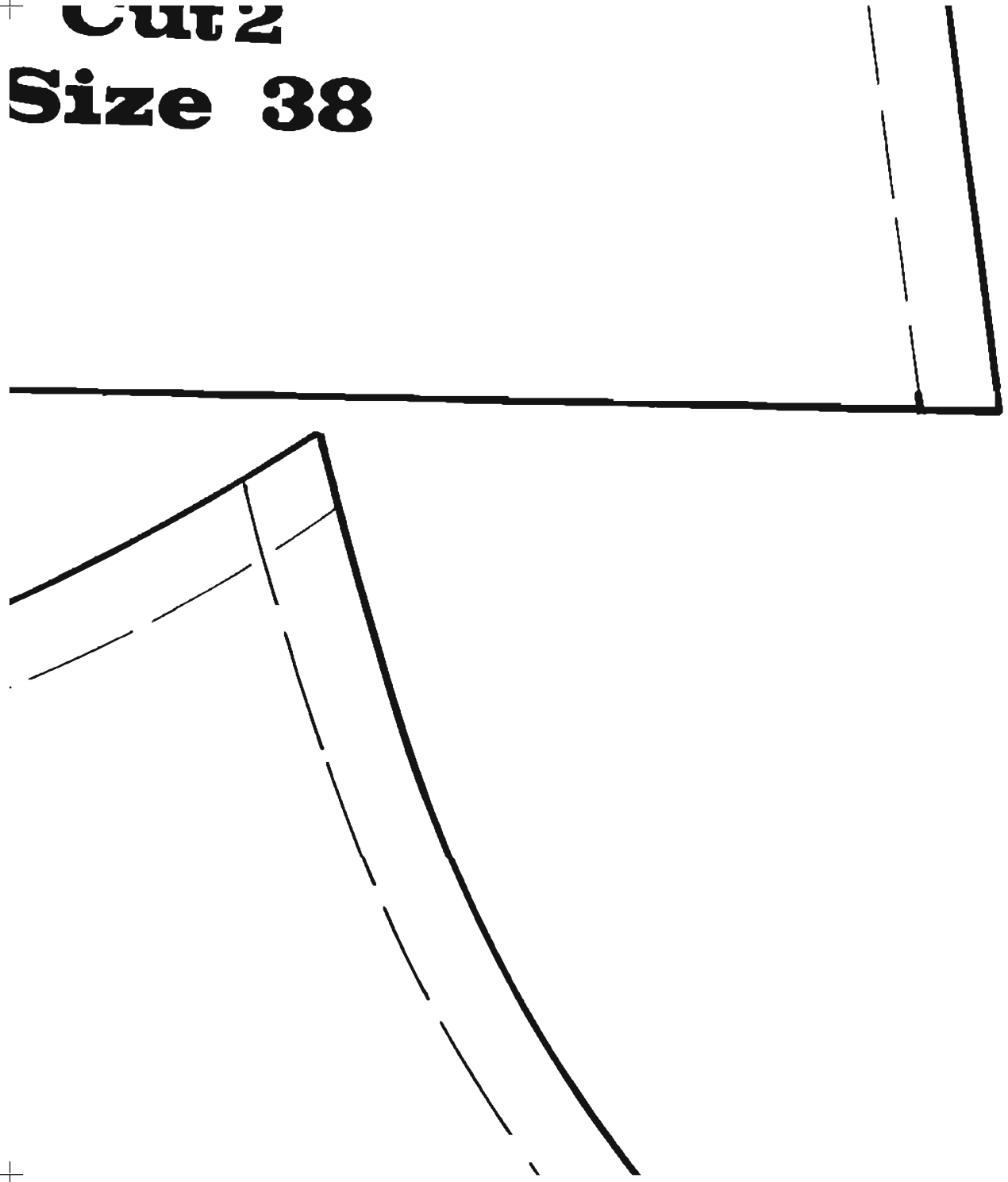

HEM LINE

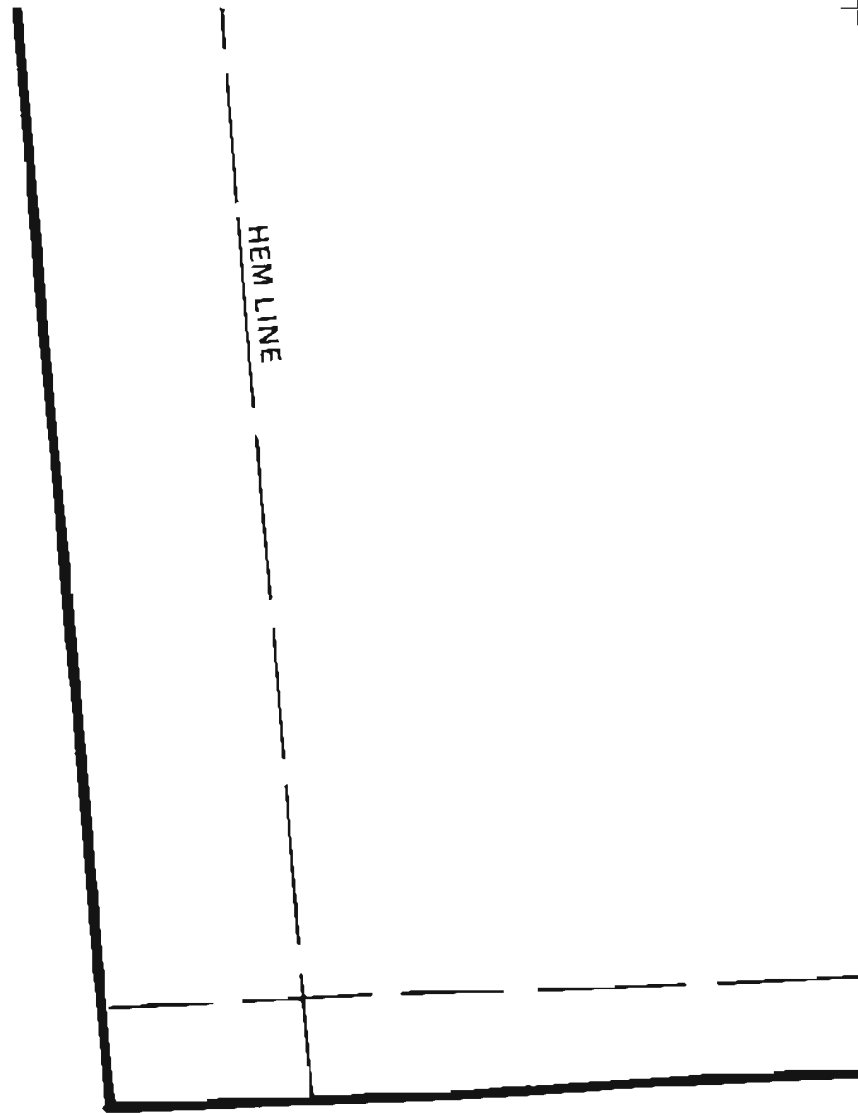

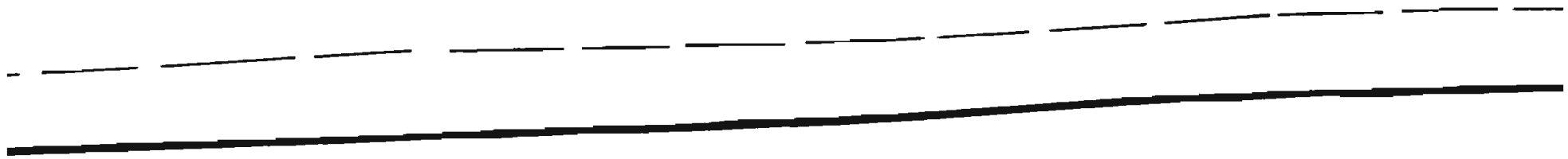

Size 38

